

MOTION CM-01/02 LI-ION TUBULAR MOTOR

Do NOT remove band around shade until installed

 **SelectBlinds®**

Pull Wand Motorization

Li-ion battery powered tube motors
with pull operation

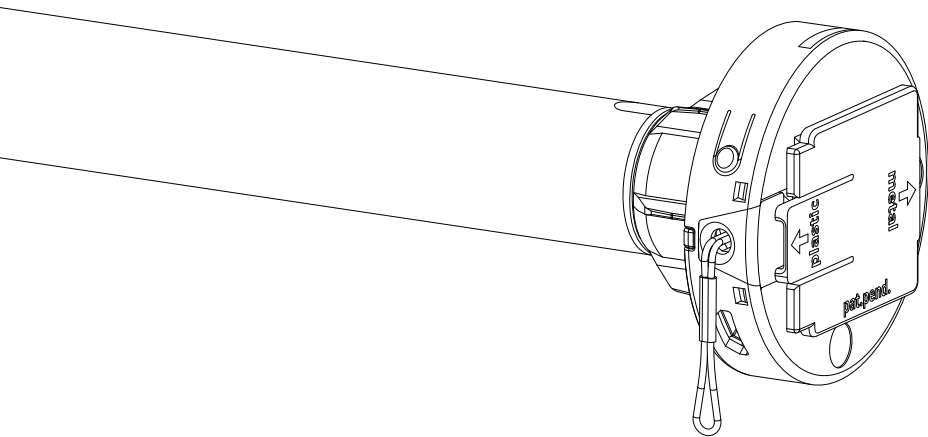

MOTION

CM-01/02
Tube motor

Li-ion battery powered tube motors
with pull operation



Motor features



Li-ion Battery

Integrated
lithium-ion battery



USB Rechargeable

Rechargeable with
micro USB

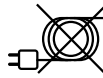

Wireless

Cable free
installation



Happy Programming

Dummy proof
programming using
pull control



Favourite Position

Preset a favourite
position

Control options



Pull Control

Operate with
pull control

Support



Video

How to install,
program and operate
rtube.nl/red983

WARNING

Read the instructions carefully before assembling and using the product. Assembly can be completed by non-professionals. For indoor use only.

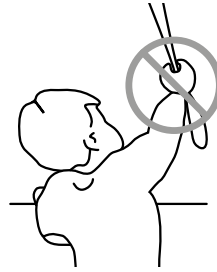

- Young children can strangle themselves with the loop of pull cords, chains and tapes, and cords that operate window coverings.
- To avoid strangulation and entanglement, keep cords out of reach of young children.
- Cords may ensnare a child's neck.
- Move beds, cots and furniture away from window covering cords.
- Do not tie cords together.
- Make sure cords do not twist together and form a loop.

Cleaning

Follow these general rules when cleaning the outside of the device and its components:

- Use a damp, soft, lint-free cloth. Avoid getting moisture in openings.
- Do not use aerosol sprays, solvents, alcohol, or abrasives.

Service & Support

Do not perform repairs yourself. Do not attempt to open the device or disassemble it. You run the risk of electric shock and voiding the limited warranty. No user-serviceable parts are inside.

Warranty Service

First follow the advice in this manual. If the product appears to be damaged or does not function properly, go to your local dealer for instructions on how to obtain warranty service.



IP 20



Conforms to
UL Std. 325
Certified to
CSA Std. C22.2#247

Important Safety instructions

WARNING: To reduce the risk of severe injury or death, it is important to follow these instructions for personal safety. Save these instructions.

- Read and follow all installation instructions.
- This appliance can be used by children aged 8 years and above and persons with reduced physical, sensory or mental capabilities or lack of experience and knowledge if they have been given supervision or instruction concerning use of the appliance in a safe way and understand the hazards involved. Children should not play with the appliance. Cleaning and user maintenance should not be performed by unsupervised children.
- Do not allow children to play with fixed controls. Keep remote controls away from children.
- Frequently examine the installation for imbalance and signs of wear or damage to cables and springs. Do not use if repair or adjustment is necessary.
- This instruction manual is also available on the website.
- The drive shall be disconnected from its power source during cleaning, maintenance and when replacing parts.
- The A-weighted emission sound pressure level of the drive is equal to or less than 70dB(A).
- Indoor and household use only.
- Disconnect the drive from the supply or switch off the automatic controls when maintenance, such as window cleaning, is being carried out in the vicinity.
- When operating a biased switch, make sure that other persons are kept away.
- Do not operate when maintenance, such as window cleaning, is being carried out in the vicinity.
- The tube motor must only be supplied with safety extra low voltage corresponding to the marking on the appliance.
- This appliance contains batteries that are non-replaceable.

Important Installation instructions

WARNING: Important safety instructions. Follow all instructions, since incorrect installation can lead to severe injury.

- This motor can only be used with soft material for driven parts.
- Hazardous unprotected moving parts of the drive must be installed higher than 2.0m above the floor or any other level surface that could provide access to it.
- Install the actuating member of a manual release at a height less than 1.8m.
- The actuating member of a biased switch is to be located within direct sight of the driven part but away from moving parts. It is to be installed at a minimum height of 1.5m and not accessible to the public.
- The mass and the dimension of the driven part must be compatible with the rated torque and rated operating time.
- Fixed controls have to be clearly visible after installation.
- The driven part must be compatible with the rated torque (0.2N.m/0.65N.m) and rated operating time (12min).
- Minimum tube diameter: $\varnothing 25\text{mm}$.
- The drive is intended to be installed at a height of at least 2.0m above the floor or any other accessible level surface.
- All-pole disconnection switches must be incorporated in the fixed wiring in accordance with the wiring rules.

1 Installing the blind



2

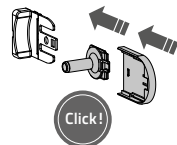

3

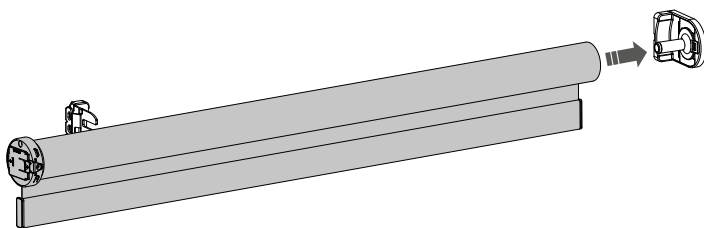

4

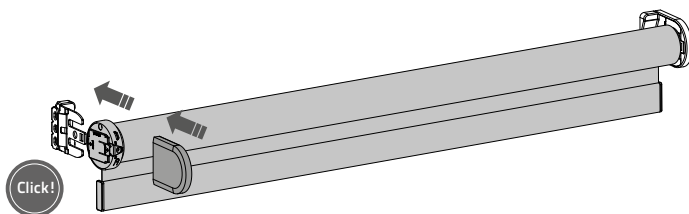

5 Charge to activate the motor

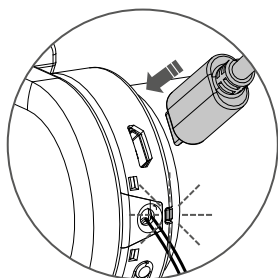

i Charge before first use. (See step 17)
A green LED will flash.
The motor can be used during charging.

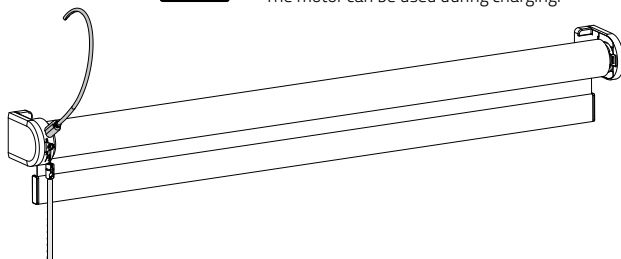

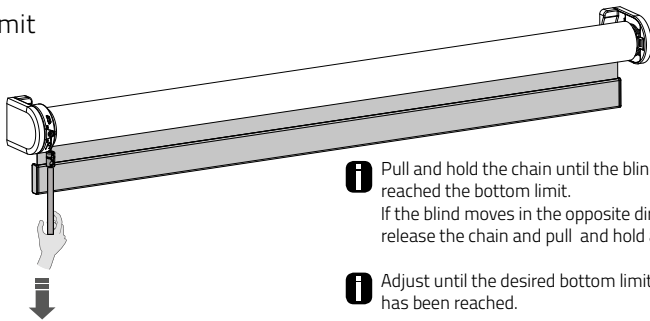
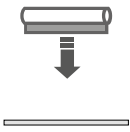
6 Set bottom limit

- i** Pull and hold the chain until the blind has reached the bottom limit. If the blind moves in the opposite direction, release the chain and pull and hold again.
- i** Adjust until the desired bottom limit has been reached.

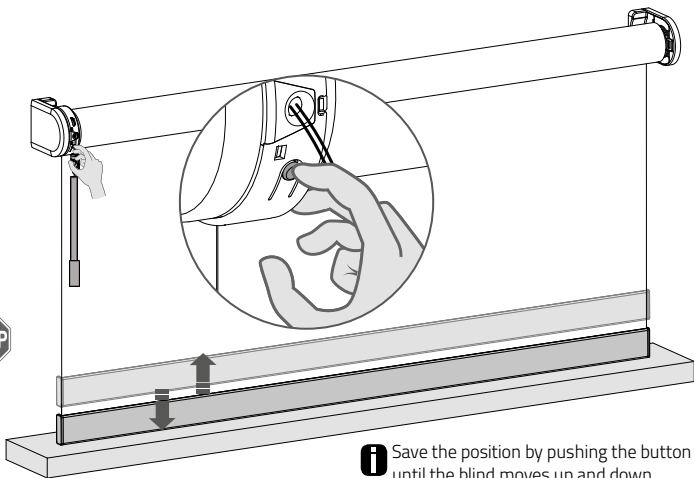
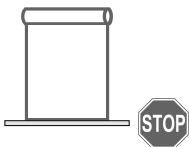
7

- i** Save the position by pushing the button until the blind moves up and down.

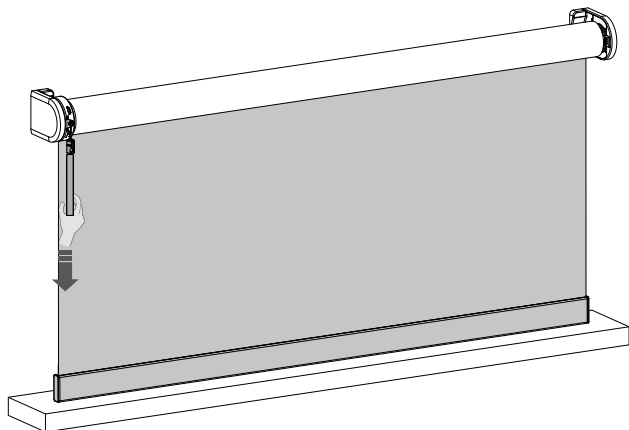
8 Set upper limit

- i** Pull and hold the chain until the blind has reached the upper limit. If the blind moves in the opposite direction, release the chain and pull and hold again.
- i** Adjust until the desired upper limit has been reached

9

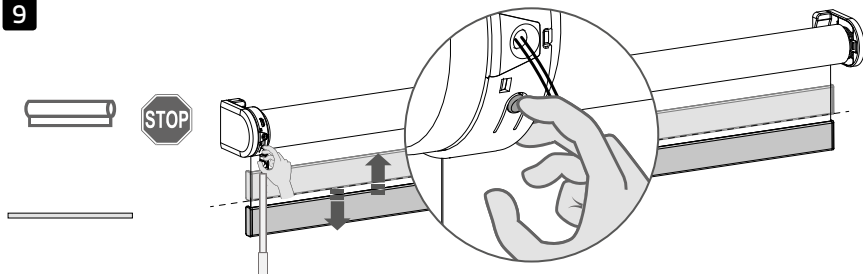

i Save the position by pushing the button until the blind moves up and down.

10 Operating the blind

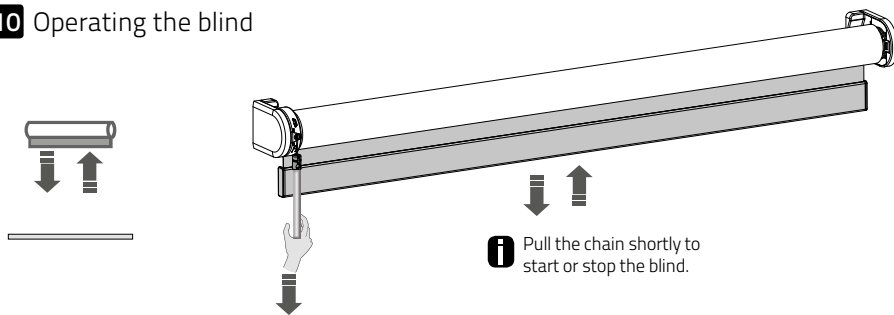

i Pull the chain shortly to start or stop the blind.

11 Optional: set favourite position

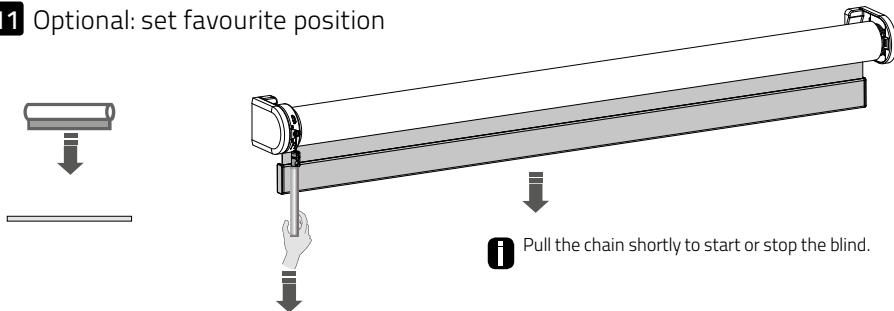

i Pull the chain shortly to start or stop the blind.

12

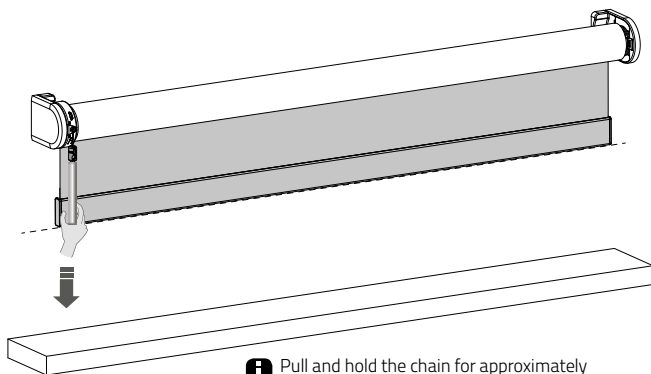
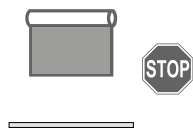

i Pull and hold the chain for approximately 7 seconds until the blind moves up and down.

13

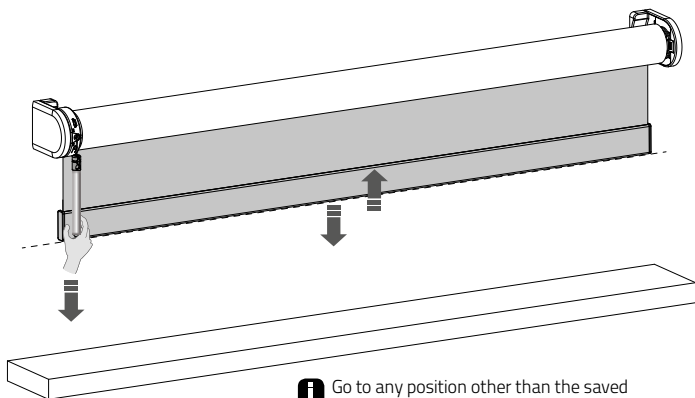
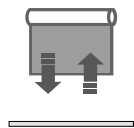

i Go to any position other than the saved favourite position.

14 Move to favourite position

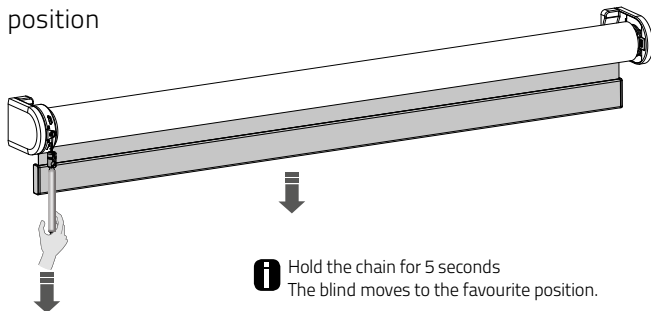
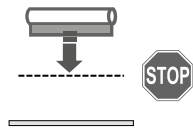

i Hold the chain for 5 seconds
The blind moves to the favourite position.

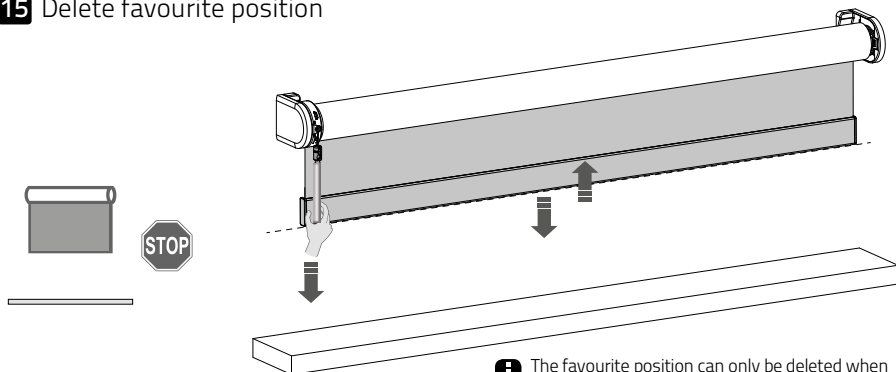
15 Delete favourite position

- i** The favourite position can only be deleted when the blind is placed in the favourite position.
- i** Pull and hold the chain for approximately 7 seconds until the blind moves up and down.
- i** Go to step 11 to program a new favourite position.

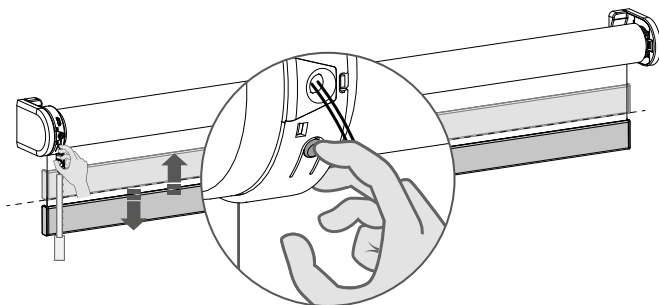
16 Delete end limits

- i** Hold the button for approximately 10 seconds. After 5 seconds, the blind will move up and down. Keep pushing the button until the blind moves up and down again.
- i** Repeat steps 6 - 9 to save new end limits.

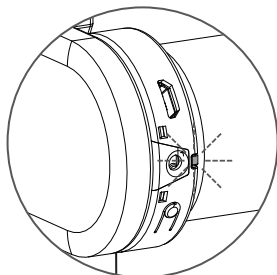
17 Recharge battery

Blinking red during
operation;
Charge the battery

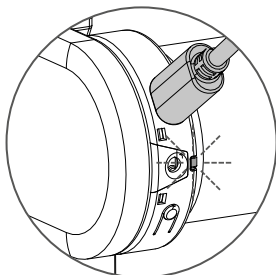

Blinking green;
battery is charging

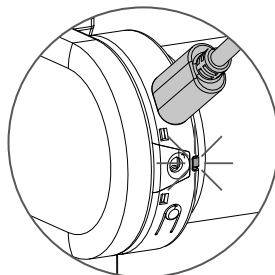

Continuously green;
battery is fully charged

18 Activate / deactivate the motor

i To prevent the blind from getting damaged, the motor has a transport mode that makes sure the blind will not be activated before installation.

18.1 Hold the program button and pull twice to activate or deactivate the motor.
The motor can also be activated by charging it with a micro USB cable.

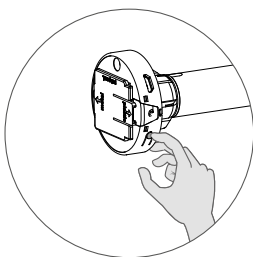

+

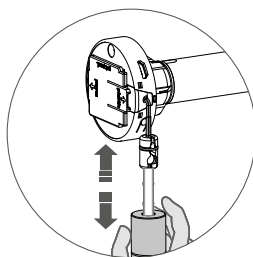

or

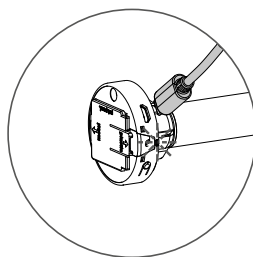

Frequently Asked Questions

Problem	Cause	Solution
Motor is not responding.	Motor is in transport mode.	Activate the motor. See step 18.
	Motor battery is empty.	Charge the motor. See step 17.
Motor LED flashes red.	The battery of the motor is empty.	Charge the motor. See step 17.
Motor is not charging.	Charger is not plugged in or does not work.	Try a different charger or make sure the charger is plugged into the outlet.
Blind lowers too far.	End limits are programmed incorrectly.	Reprogram end limits. See step 6 - 9.
Unable to program end limits.	End limits have already been programmed.	Reset the motor and reprogram end limits. See step 16 and step 6-9.



Wireless Pull Wand Motorization

Li-ion battery powered tube motors
with pull and remote operation

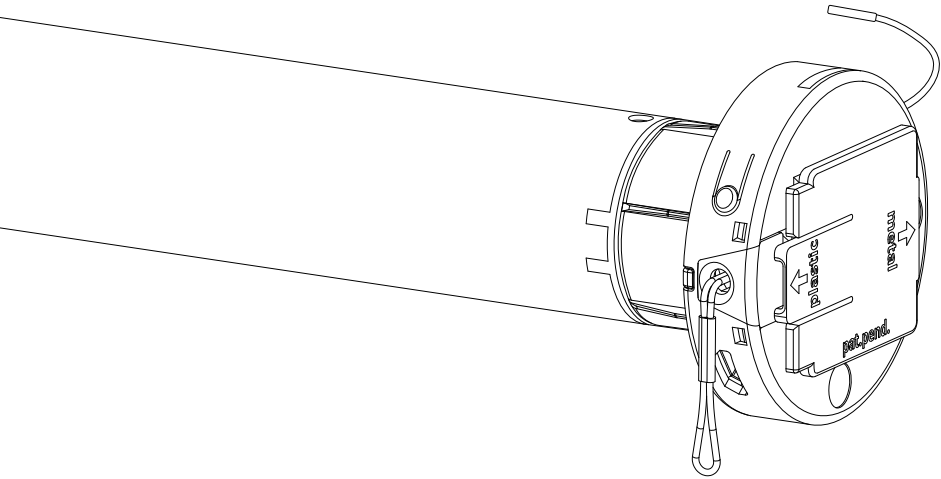

MOTION

CM-03/05

Li-ion battery powered tube motors with
pull and remote operation

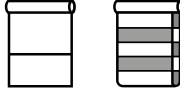

Motor features



Li-ion Battery
Integrated
lithium-ion battery



USB Rechargeable
Rechargeable with
micro USB

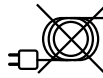

Wireless
Cable free
installation



Speed Control
Consistent
rolling speed



Bi-directional
Two-way
communication for
real-time response

Control options



Pull Control
Operate with
pull control



Remote Control
Operate with a
remote control



App Control
Operate with the
MOTION app



Connectivity
Compatible with
home and building
automation

Support



Video
How to install,
program and operate
rtube.nl/red980



App Store
Download the
MOTION app
rtube.nl/red981



Google Play
Download the
MOTION app
rtube.nl/red982

WARNING

Read the instructions carefully before assembling and using the product. Assembly can be completed by non-professionals. For indoor use only.

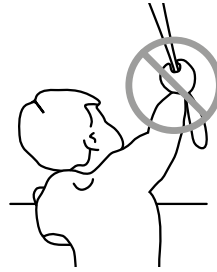

- Young children can strangle themselves with the loop of pull cords, chains and tapes, and cords that operate window coverings.
- To avoid strangulation and entanglement, keep cords out of reach of young children.
- Cords may ensnare a child's neck.
- Move beds, cots and furniture away from window covering cords.
- Do not tie cords together.
- Make sure cords do not twist together and form a loop.

Cleaning

Follow these general rules when cleaning the outside of the device and its components:

- Use a damp, soft, lint-free cloth. Avoid getting moisture in openings.
- Do not use aerosol sprays, solvents, alcohol, or abrasives.

Service & Support

Do not perform repairs yourself. Do not attempt to open the device or disassemble it. You run the risk of electric shock and voiding the limited warranty. No user-serviceable parts are inside.



IP 20



Conforms to
UL Std. 325
Certified to
CSA Std. C22.2#247

Important Safety instructions

WARNING: To reduce the risk of severe injury or death, it is important to follow these instructions for personal safety. Save these instructions.

- Read and follow all installation instructions.
- This appliance can be used by children aged 8 years and above and persons with reduced physical, sensory or mental capabilities or lack of experience and knowledge if they have been given supervision or instruction concerning use of the appliance in a safe way and understand the hazards involved. Children should not play with the appliance. Cleaning and user maintenance should not be performed by children without supervision.
- Do not allow children to play with fixed controls. Keep remote controls away from children.
- Frequently examine the installation for imbalance and signs of wear or damage to cables and springs. Do not use if repair or adjustment is necessary.
- This instruction manual is also available on the website.
- The drive must be disconnected from its power source during cleaning, maintenance and when replacing parts.
- The A-weighted emission sound pressure level of the drive is equal to or less than 70dB(A).
- Indoor and household use only.
- Disconnect the drive from the power supply or switch off the automatic controls when maintenance, such as window cleaning, is being carried out in the vicinity.
- When operating a biased switch, make sure that other persons are kept away.
- Do not operate when maintenance, such as window cleaning, is being carried out in the vicinity.
- The tube motor must only be supplied with safety extra low voltage corresponding to the marking on the appliance.
- This appliance contains batteries that are non-replaceable.

Important Installation instructions

WARNING: Important safety instructions. Follow all instructions, since incorrect installation can lead to severe injury.

- This motor can only be used with soft material for driven parts.
- Hazardous unprotected moving parts of the drive must be installed higher than 2.5m above the floor or any other level surface that could provide access to it.
- Install the actuating member of a manual release at a height less than 1.8m.
- The actuating member of a biased switch is to be located within direct sight of the driven part but away from moving parts. It is to be installed at a minimum height of 1.5m and not accessible to the public.
- The mass and the dimension of the driven part must be compatible with the rated torque and rated operating time.
- Fixed controls have to be clearly visible after installation.
- The driven part must be compatible with the rated torque (1.1N.m/2.2N.m) and rated operating time (12min).
- Minimum tube diameter: $\varnothing 25\text{mm}$.
- The drive is intended to be installed at a height of at least 2.5m above the floor or any other accessible level surface.
- All-pole disconnection switches must be incorporated in the fixed wiring in accordance with the wiring rules.

FCC Manual

This device complies with Part 15 of the FCC Rules. Operation is subject to the following two conditions: (1) this device may not cause harmful interference, and (2) this device must accept any interference received, including interference that may cause undesired operation.

FCC ID: ZY4CM03

FCC ID: ZY4CM05

Regulatory Information

1 FCC Information for User

This product does not contain any user serviceable components and is to be used with approved antennas only. Any product changes or modifications will invalidate all applicable regulatory certifications and approvals.

2 FCC Electronic Emission Notices

This device complies with part 15 of the FCC Rules. Operation is subject to the following two conditions:

1. This device may not cause harmful interference
2. This device must accept any interference received, including interference that may cause undesired operation.

3 FCC Radio Frequency Interference statement

This equipment has been tested and found to comply with the limits for a class B digital device, pursuant to Part 15 of the FCC Rules. These limits are designed to provide reasonable protection against harmful interference when the equipment is operated in a commercial environment. This equipment generates, uses and can radiate radio frequency energy and, if not installed and used in accordance with the instructions, may cause harmful interference to radio communications.

Operation of this equipment in a residential area may cause harmful interference, in which case the user will be required to correct the interference at

their own expense.

If this equipment does cause harmful interference to radio or television reception, which can be determined by turning the equipment off and on, the user is encouraged to try to correct the interference by one or more of the following measures:

- Reorient or relocate the receiving antenna
- Increase the distance separating the equipment and receiver
- Connect the equipment to an outlet on a circuit different from that to which the receiver is connected
- Consult the dealer or an experienced radio/TV technician for help

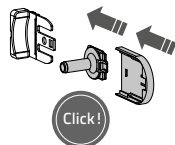
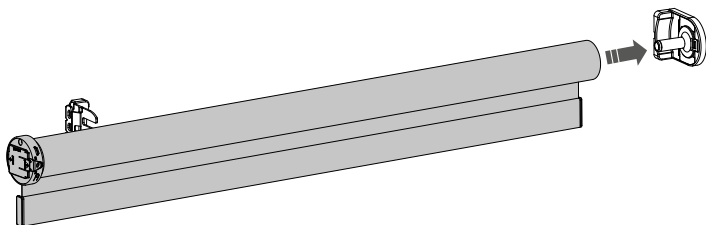
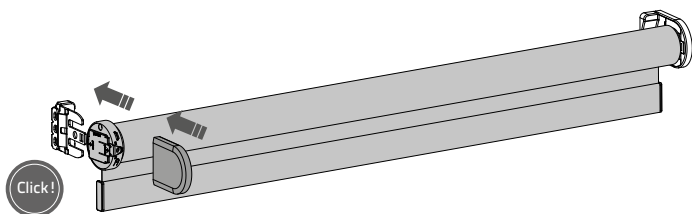
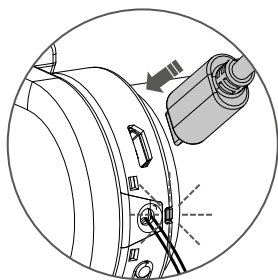
1 Install the blind**2****3****4****5** Activate the motor

Activate the motor by charging it with a micro USB cable. A green LED will start flashing. The motor can be used during charging. (To activate the motor without a micro USB cable, see step 25)

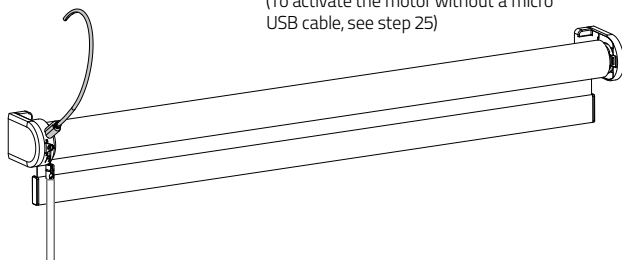

6 Pair a remote

i Pair a remote control that is able to program blinds. See pages 4 and 5 for remote control details. In this manual, CM-12 is displayed.

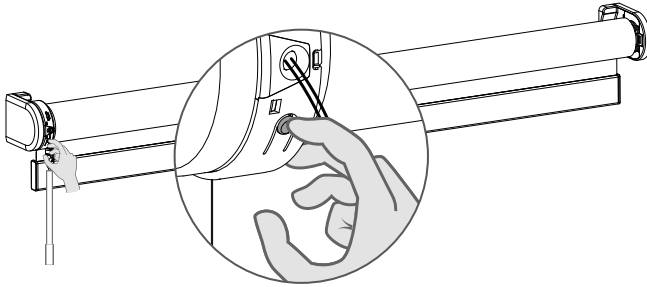

6.1 Shortly press the **program** button on the motor. The blind will start stepping, indicating that program mode has been activated. (The blind keeps stepping until the program mode is deactivated.)

6.2 Select a desired channel for the blind using the **channel selection** button on the remote control.

6.3 Press the **pair** button on the back of the remote control to pair the blind with the selected channel. The blind will shortly stop stepping, indicating that the remote has been paired to the blind.

i Repeat steps 6.1 - 6.3 to remove a blind from a channel.

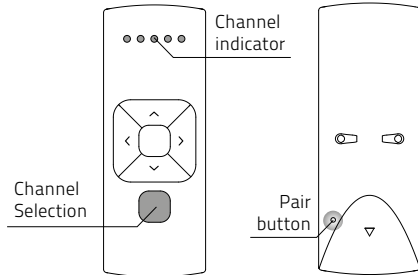

i End limits must be programmed to use a blind properly and to prevent it from being damaged. Proceed to step 12 if end limits are already set.

7 Check rotational direction



WARNING: risk of damage.
Stop the blind before reaching the end positions.

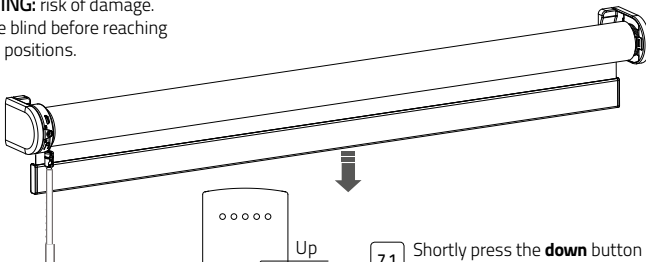

7.1 Shortly press the **down** button to check if the blind unrolls the right way. If the blind moves up, the rotational direction must be changed.

7.2 Simultaneously press the **up** and **down** button to change the rotational direction.

8 Set bottom position

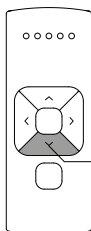
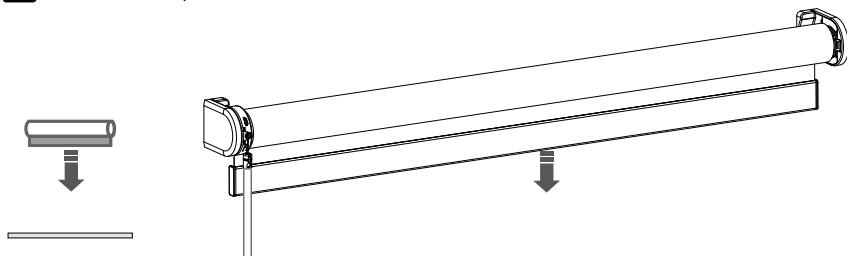

8.1 Press and hold the **down** button until the blind reaches the desired bottom position.

WARNING: risk of damage.
Slowly approach the bottom position.

9

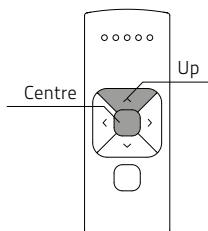
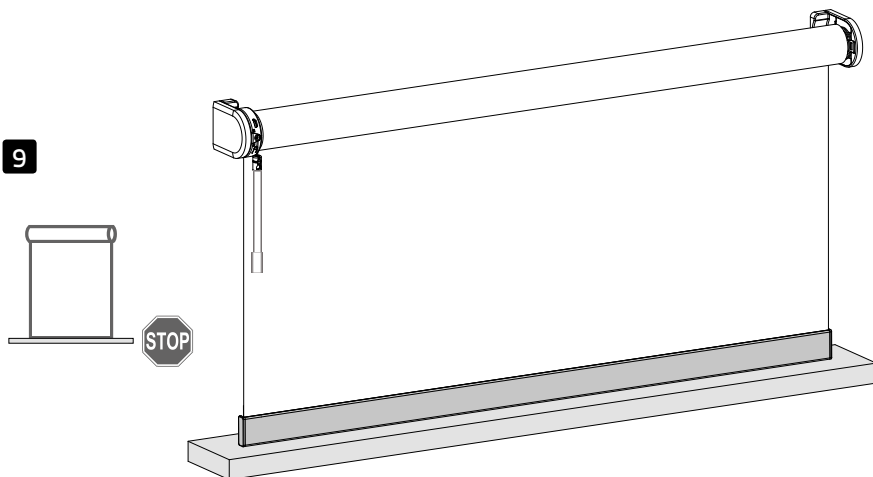

9.1 Simultaneously hold the **centre** and the **up** button until the blind stops stepping and starts stepping again. The bottom position has been saved.

10 Set top position

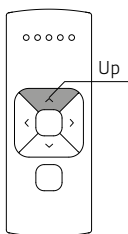
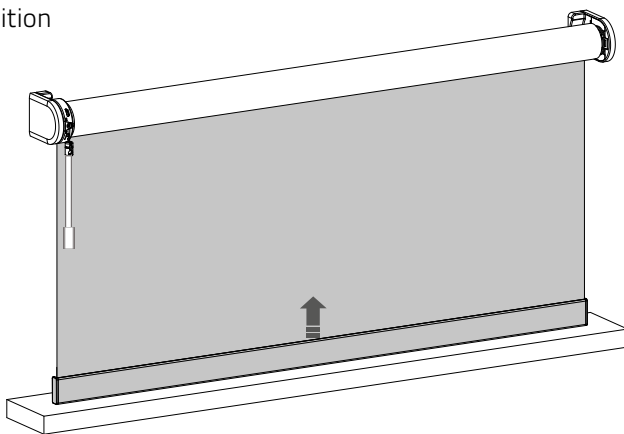

10.1 Press and hold the **up** button until the blind reaches the desired top position.

WARNING: risk of damage.
Slowly approach the top position.

11

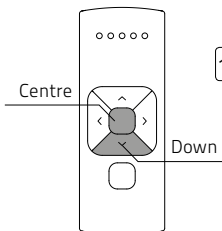
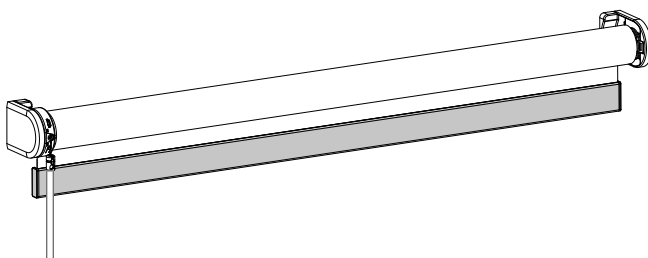
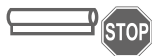

11.1 Simultaneously hold the **centre** and the **down** button until the blind stops stepping and starts stepping again.

The top position has been saved.

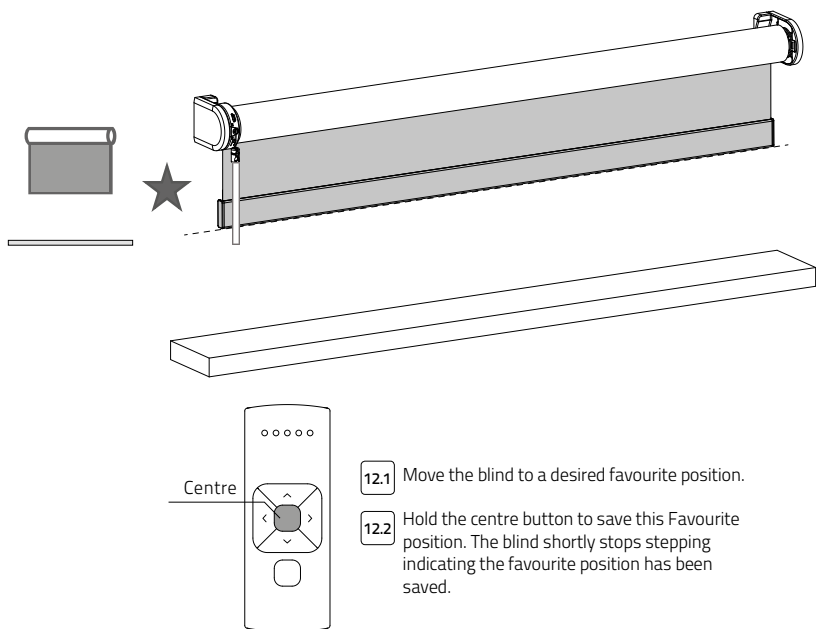
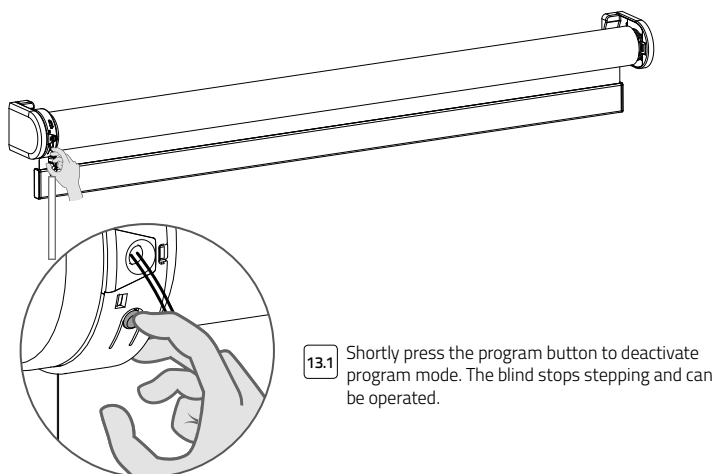
12 Set favourite position (optional)**13** Deactivate program mode

14 Operate the blind

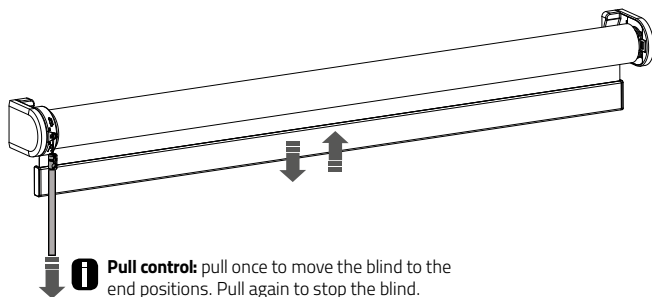
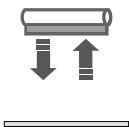

i Pull control: pull once to move the blind to the end positions. Pull again to stop the blind.

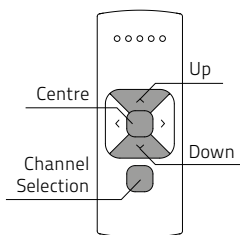

i Remote control: Choose the channel with which the blind has been paired using the **channel** button. Press the **up** or **down** button to operate the blind. Press the **centre** button to stop the blind.

15 Move to favourite position

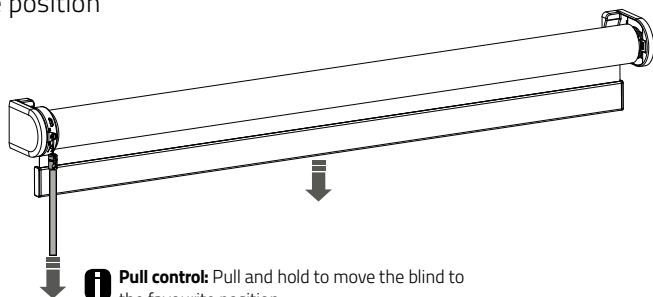
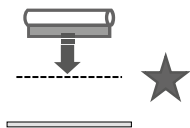

i Pull control: Pull and hold to move the blind to the favourite position.

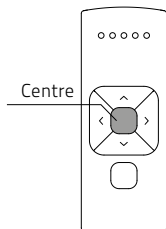

i Remote control: press the **centre** button to move the blind to the favourite position.

16 Reset favourite position

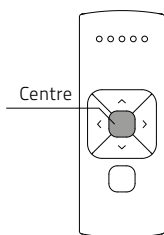
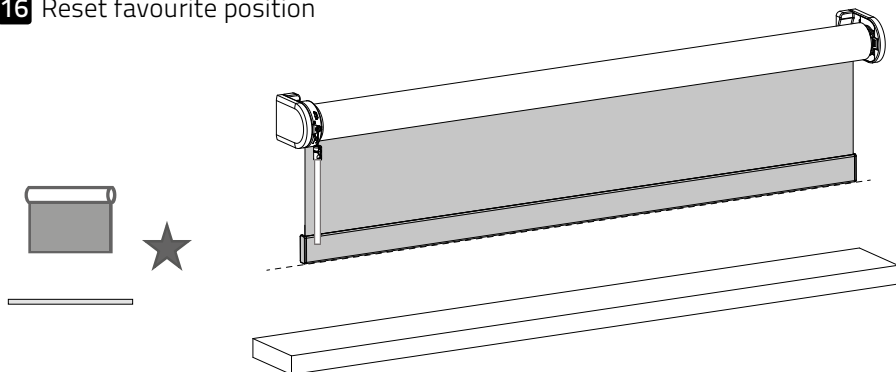

- 16.1 Move the blind to a desired favourite position.
- 16.2 Press the **program** button on the motor to activate program mode. The blind starts stepping.
- 16.3 Hold the **centre** button to save this favourite position. The blind shortly stops stepping, indicating the favourite position has been saved successfully.
- 16.4 Press the **program** button on the motor to deactivate program mode. The blind stops stepping.

17 Deactivate direct control

i When pressing the up or down button on the remote control, the blind directly moves to its end positions (direct control). To operate the blind with smaller steps using the up and down button, direct control can be deactivated. Now, the blind only directly moves to its end positions when the up or down button is held longer than two seconds.

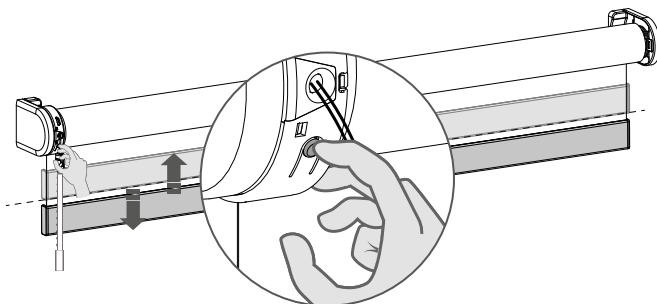

- 17.1 Press the **program** button on the motor to activate program mode. The blind starts stepping.
- 17.2 Hold the **program** button until the blind stops stepping (approximately 5 seconds) to deactivate or reactivate direct control.

18 Reset the blind

- i** It is possible to only delete end limits or to do a factory reset.
Factory reset will delete the end limits and remove the connection to any paired remote.

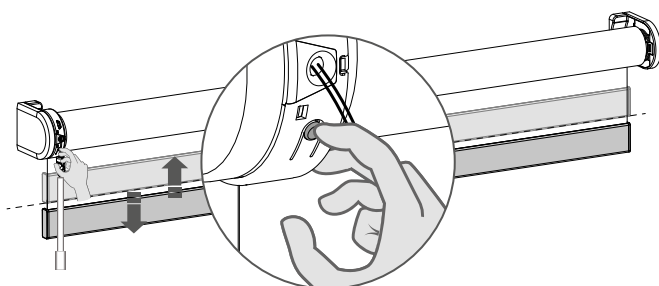

18.1 Press the program button on the motor to activate program mode.

- i** **Delete end limits:** to delete the end limits of the blind, hold the **program** button until the blind stops stepping for the first time, and keep holding the button until the blind stops stepping for the second time. (approximately 10 seconds)
- i** **Factory reset:** to reset the blind to factory defaults hold the button for at least 20 seconds. The blind will stop stepping twice. After the second stop the blind will give one extra step to confirm factory reset.

19 Recharge the battery

Use a micro USB cable
to charge the motor

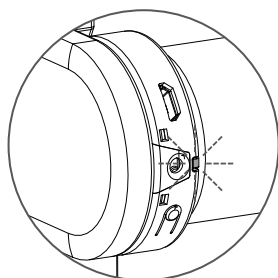

LED light flashes
red during operation;
Charge the battery

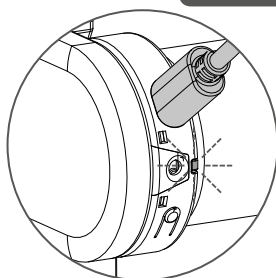

LED light flashes
green;
battery is charging

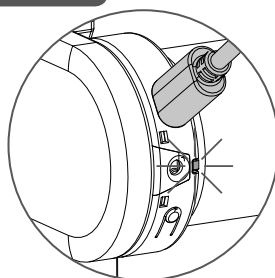

LED light constantly
green;
battery is fully charged

i Advanced options

20 Manual control

i In case there is no remote control or pull control, the blind can be operated with the program button on the motor.

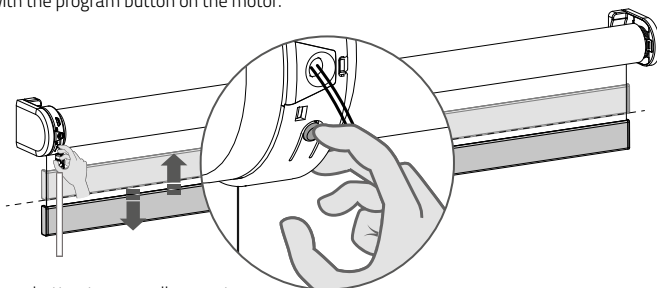

20.1 Hold the **program** button to manually operate the blind. The blind will move as long as the button is being pressed. (max. 15 sec.)

20.2 To move the blind in opposite direction, release the **program** button and repeat step 20.1.

21 Single select 5 channel remote

i Single select makes it possible to activate program mode on a single blind through a remote control, without having to physically press the program button on the blind.

21.1 To activate Single select, simultaneously hold the **centre** button and press the **pair** button.

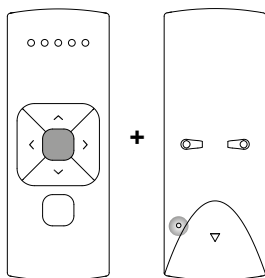

21.2 The remote starts searching for blinds (search mode). This is indicated by the LEDs flashing from left to right.

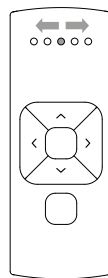

21.3 Once a blind is found, the channel LED will flash and the blind starts stepping, indicating that program mode has been activated. The blind can now be (un)paired to the remote and/or programmed.

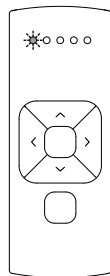

21.4 To search for the next blind, press the **right** button. Search mode will be activated. To find the previous blind, press the left button.

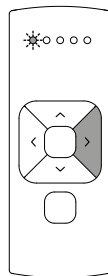

21.5 To exit Single select, press the **right** button during search mode.

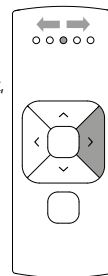

22 Single select 15 channel remote

i Single select makes it possible to activate program mode on a single blind through a remote control, without having to physically press the program button on the blind.

22.1 To activate Single select, simultaneously hold the **centre** button and press the **pair** button.

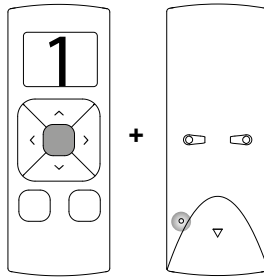

22.2 The remote starts searching for blinds (search mode). This is indicated by the horizontal bars on the remote.

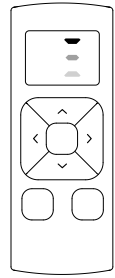

22.3 Once a blind is found, the channel number will flash and the blind starts stepping, indicating that program mode has been activated. The blind can now be (un)paired to the remote and/or programmed.

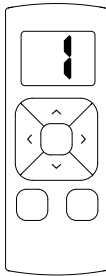

22.4 To search for the next blind, press the **right** button. Search mode will be activated. To find the previous blind, press the left button.

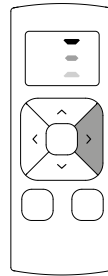

22.5 To exit Single select, press the **right** button during search mode. The display shows the letter **O**.

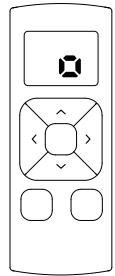

23 Channel select 5 channel remote

i Channel select makes it possible to copy blinds in between channels/remotes without having to physically press the program button on the motors.

23.1 Select the channel from which the blinds must be copied.

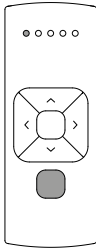

23.2 To activate channel select, simultaneously hold the **channel selection** button and press the **pair** button.

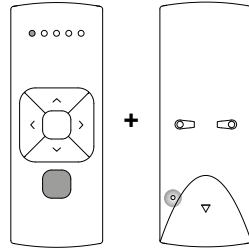

23.3 All blinds in the selected channel will start stepping, indicating program mode has been activated. All blinds can be copied to a new channel on the same remote or a different remote. Select a new channel on the (new) remote.

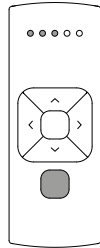

23.4 Press the pair button on the (new) remote to pair the blinds with the new channel.

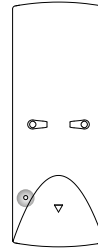

23.5 To exit channel select, go back to the channel selected at step 23.1 and repeat step 23.2

24 Channel select 15 channel remote

i Channel select makes it possible to copy blinds in between channels/remotes without having to physically press the program button on the motors.

24.1 Select the channel you would like to copy.

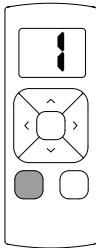

24.2 To activate channel select, simultaneously hold the **channel selection** button and press the **pair** button.

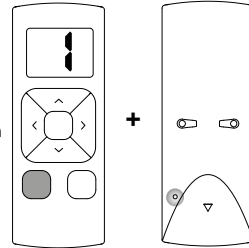

24.3 All blinds in the selected channel will start stepping, indicating program mode has been activated. All blinds can be copied to a new channel on the same remote or to different remotes. Select a channel on a (new) remote.

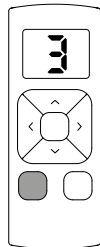

24.4 Press program button on the (new) remote to pair the blinds with the (new) remote.

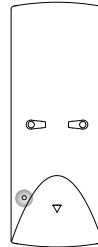

24.5 To exit channel select, choose the channel you selected at step 24.1 and repeat step 24.2

25 Activate / deactivate the motor

i To prevent the blind from getting damaged, the motor has a transport mode that makes sure the blind will not be activated before installation.

25.1 Hold the program button and pull twice to activate or deactivate the motor.
The motor can also be activated by charging it with a micro USB cable.

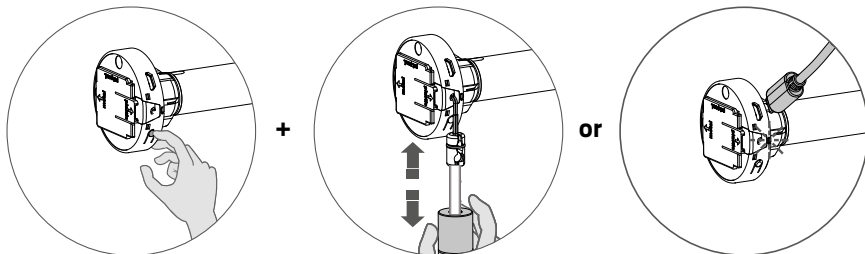

Frequently Asked Questions

Problem	Cause	Solution
Blind does not work.	Motor is in transport mode.	Activate the motor. See step 25.
	Motor battery is empty.	Charge the motor. See step 19.
	Remote battery is empty. (LEDs of remote are flashing rapidly.)	Replace the battery in the remote. See the manual of the remote.
	Remote battery is inserted incorrectly.	Replace the battery in the remote. See the manual of the remote.
	Radio-frequency interference	Make sure that the antenna of the motor is out of the way of metal objects.
	The distance from the remote to the motor is too far.	Move closer to the motor.
	The remote is not connected to the blind.	Pair the remote with the motor. See step 6.
Motor LED flashes red.	The battery of the motor is empty.	Charge the motor. See step 19.
Blind is not charging.	Charger is not plugged in or does not work.	Try a different charger or make sure the charger is plugged in the outlet.
Multiple blinds respond to a remote. (Unable to program a single blind)	Multiple blinds are paired with a single channel.	Pair the blind with a free channel to program or use single select to program the blind.
Blind moves in small steps.	1) No end limits are programmed. 2) Direct control is deactivated.	1) Program end limits. See step 8 - 11. 2) Activate direct control. See step 17.
Favourite position can not be programmed.	No end limits are programmed.	Program end limits. See step 8 - 11.
Blind lowers too far.	End limits are programmed incorrectly.	Reprogram end limits. See step 8 - 11.
Blind moves in the opposite direction.	The rotational direction has been set incorrectly.	Change the rotational direction. See step 7.
The blind keeps moving up and down.	The blind is in program mode.	Press the program button on the motor to exit program mode.

MOTION

MANUAL CM-20

MOTION Wi-Fi bridge

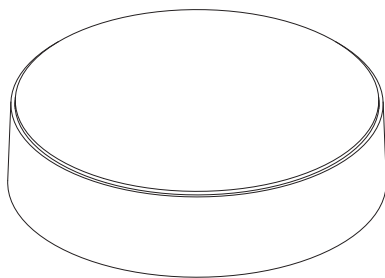

The MOTION Wi-Fi bridge is the heart of your automated blinds network at home. The bridge unlocks endless possibilities to operate blinds with the MOTION app. Cloud connections with leading smart home applications enable voice control and a variety of smart automation options.

Max. blinds	Scenes	Timers	Frequency	Range radio	Power supply	Length	Height	Certificates
30	20	20	433 MHz 2.4 GHz	30 m	Micro USB DC 5V 1A	100 mm \varnothing	25 mm	CEFC

This box includes the following items:

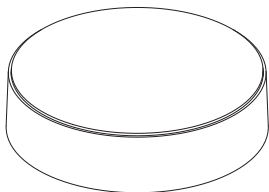

CM-20 MOTION Wi-Fi Bridge

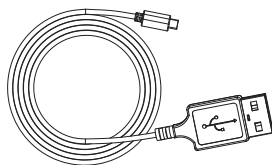

Micro-USB cable 75cm



For the latest information and updated manuals, visit rtube.nl/cm-20

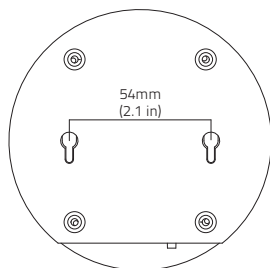
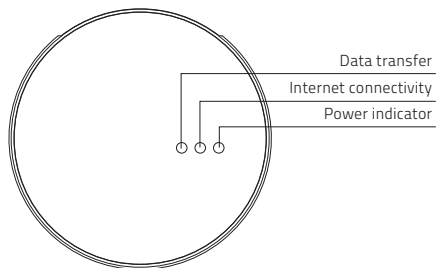
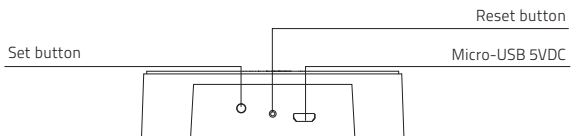

Regulatory Information

1 FCC Information for User

This product does not contain any user-serviceable components and is to be used with approved antennas only. Any product changes or modifications will invalidate all applicable regulatory certifications and approvals.

2 FCC Electronic Emission Notices

This device complies with part 15 of the FCC Rules. Operation is subject to the following two conditions:

1. This device may not cause harmful interference
2. This device must accept any interference received, including interference that may cause undesired operation.

3 FCC Radio Frequency Interference Statement

This equipment has been tested and found to comply with the limits for a class B digital device, pursuant to Part 15 of the FCC Rules. These limits are designed to provide reasonable protection against harmful interference when the equipment is operated in a commercial environment. This equipment generates, uses and can radiate radio-frequency energy and, if not installed and used in accordance with the instructions, may cause harmful interference to radio communications. Operation of this equipment in a residential area may cause harmful interference, in which case the user will be required to correct the interference at their own expense.

If this equipment does cause harmful interference to radio or television reception, which can be determined by turning the equipment off and on, the user is encouraged to try to correct the interference by one or more of the following measures:

- Reorient or relocate the receiving antenna
- Increase the distance separating the equipment and receiver
- Connect the equipment to an outlet on a circuit different from that to which the receiver is connected
- Consult the dealer or an experienced radio/TV technician for help

Safety

WARNING: Important safety instructions. Follow all instructions, since incorrect installation can lead to severe injury.

- Do not let children play with the blind and/or remote control.
- Take care that the blind can move freely and is not blocked by any objects.
- Do not paint the device.
- Keep the device dry.
- Do not drop, knock, or shake the device. Rough handling can break internal circuit boards.

Cleaning

Follow these general rules when cleaning the outside of the device and its components:

- Use a damp, soft, lint-free cloth. Avoid getting moisture in openings.
- Do not use aerosol sprays, solvents, alcohol, or abrasives.

Service & Support

Do not perform repairs yourself.

Do not attempt to open the device or disassemble it. You run the risk of electric shock and voiding the limited warranty. No user-serviceable parts are inside.

1 Download the app and create an account

- i** The MOTION Wi-Fi bridge needs to be set up with the MOTION Blinds app before installation on the wall or ceiling. Download the MOTION Blinds app from the App Store or Google Play with your smartphone or tablet. Open the MOTION app and create an account.



App Store

Download the
MOTION Blinds app
rtube.nl/red981



Google Play

Download the
MOTION Blinds app
rtube.nl/red982



1. DOWNLOAD THE APP AND CREATE AN ACCOUNT

2 Power the bridge

- i** There is no charger included with this product. Any universal DC 5V 1A micro-USB charger can be used to power the MOTION bridge.

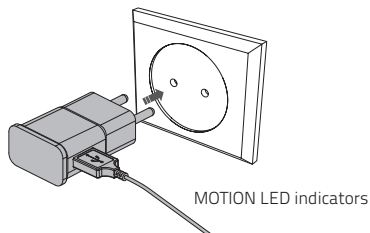

LED indicators

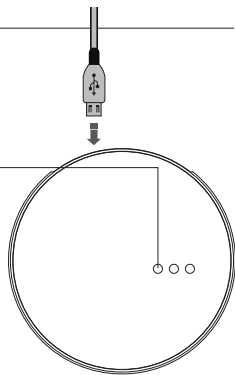

LED	Color	Status
Right	Solid Red	Bridge is powered on
Center	Blinking purple	Bridge connecting mode
Center	Blinking red	Not connected to Wi-Fi
Center	Solid Yellow	Connected to Wi-Fi, not connected to MOTION cloud
Center	Solid Blue	Connected to Wi-Fi Connected to MOTION cloud
Left	Blinking purple	Pairing blind with bridge
Left Center	Blinking green Solid blue	Bridge firmware update

2. POWER THE BRIDGE





3 Connect the bridge to a Wi-Fi network

- i** An active internet connection is required to add the MOTION bridge to your home Wi-Fi network. Choose a location for the MOTION bridge in your home. Connect your smartphone or tablet to your home Wi-Fi network to check the strength of the Wi-Fi signal at this location. To avoid interference please make sure the MOTION bridge is located at least one meter away from any other Wi-Fi devices, including your router.



Video
MOTION app:
how it works
rtube.nl/red1074



3G/4G	✗
	✗
	✗
	✓
	✓



- 3.1** Choose 'Edit' at the top right of your screen and open 'Settings'.

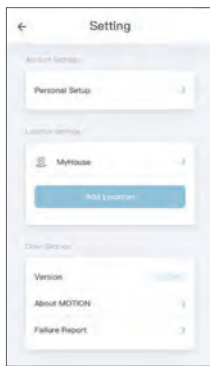

- 3.2** Click on your location (MyHouse) to add the MOTION bridge to this location.

The MOTION Blinds app allows to create 5 different locations. Up to 3 bridges can be added per location.

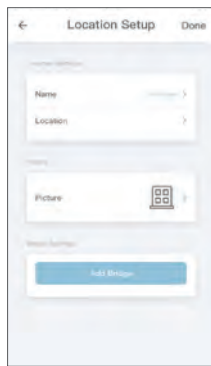

- 3.3** Press 'Add Bridge' and follow the installation wizard to setup your bridge.

3. CONNECT THE BRIDGE TO A WI-FI NETWORK



- 3.4** Make sure the MOTION bridge is powered ON. Open the Wi-Fi settings of your mobile device and connect to the Wi-Fi network you want to connect the MOTION bridge with.



- 3.5** Return to the MOTION Blinds app and enter the password of the Wi-Fi network.



- 3.6** Press and hold the 'Set' button on the MOTION bridge until the LED on top of the bridge starts to flash purple. Go to the app and press 'Connect'. Now a MOTION Wi-Fi network is created by the bridge.

3. CONNECT THE BRIDGE TO A WI-FI NETWORK



- 3.7** Keep the MOTION Blinds app running on the background, while opening the Wi-Fi settings of your mobile device.

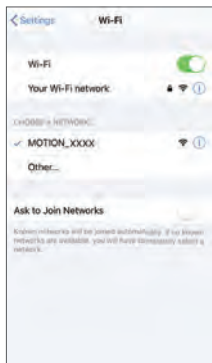

- 3.8** Choose the MOTION_XXXX network to connect with the bridge. Return to the MOTION Blinds app to finish the installation wizard.



- 3.9** The bridge automatically connects to your Wi-Fi network. The middle LED on the bridge first turns yellow and then blue. Now the bridge is connected to your Wi-Fi network and the MOTION cloud.

3. CONNECT THE BRIDGE TO A WI-FI NETWORK

4 Add a blind



- 4.1 Go back to the start screen in the app and open your location.



- 4.2 Navigate to 'Blind' and press the '+' button to add a new blind. (Make sure your blind has a top and bottom position programmed. If your blind does not have end positions please program first.)



- 4.3 Choose the blind type and follow the setup wizard.

- i** Before adding a blind to the MOTION bridge, the end positions of the blind must be programmed with a remote control.

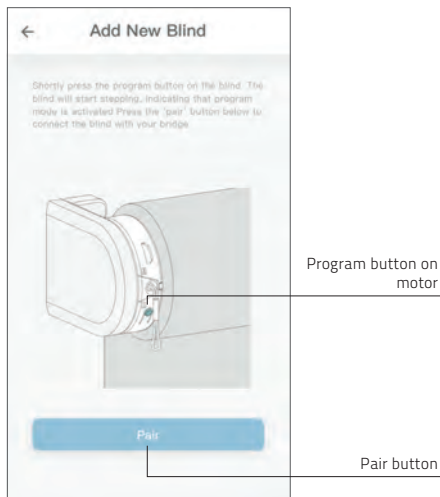

4.4

Shortly press the program button on the blind. (Please see the manual of your motor to see where the program button is located.) The blind will start stepping, indicating that program mode is activated. Press the 'pair' button to connect the blind with your bridge.

4. ADD A BLIND

5 Roller/ Honeycomb/ Roman blind control

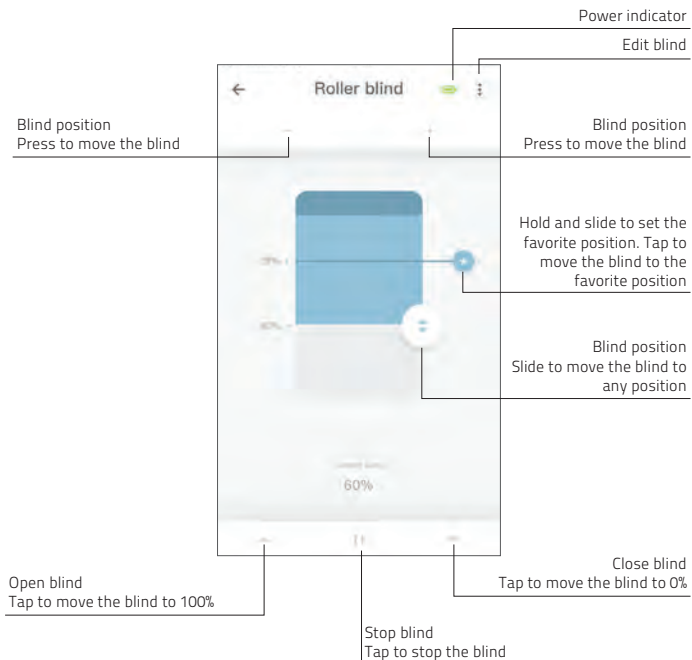

5. ROLLER BLIND CONTROL

6 Double roller control

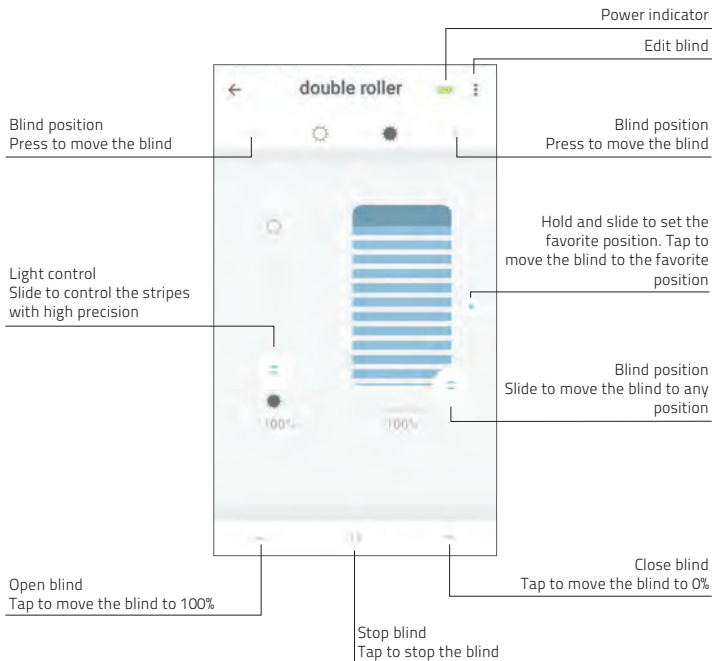

6. DOUBLE ROLLER CONTROL

7 Top-down/Bottom-up control

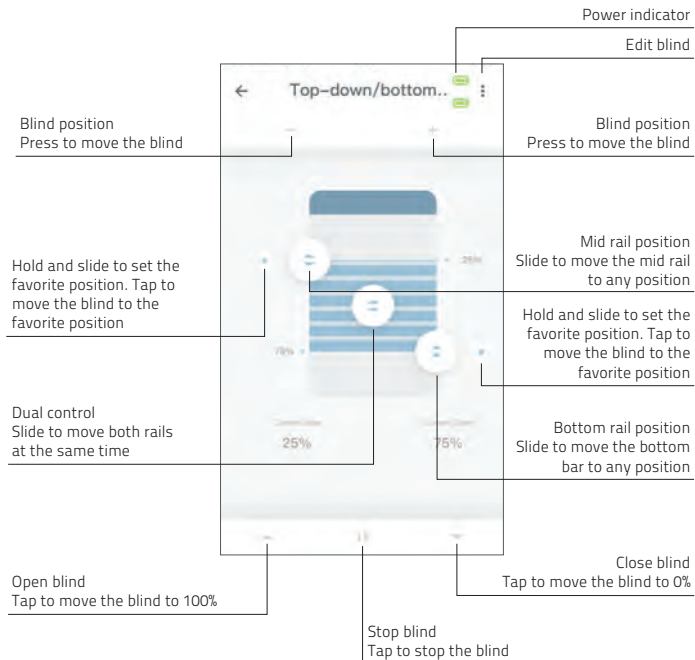

7. TOP-DOWN/BOTTOM-UP CONTROL

8 Venetian control

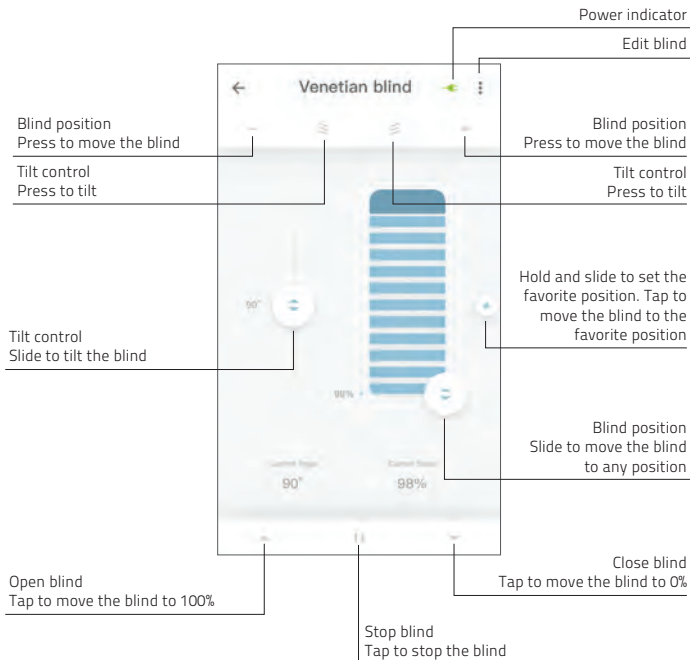

8. VENETIAN CONTROL

9 Create a room

i Add blinds to a room to control individual blinds or all blinds in a room at the same time. Shortly click on a room to see/control all the blinds in this room



Add room

9.1 Press the '+' button to add a new room.

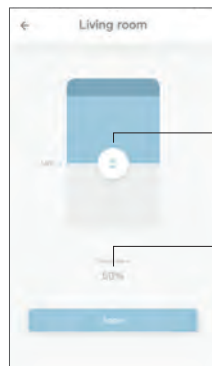

Position slider

Target Position

9.2 Click and hold on a room and control all the blinds to a certain position.

9. CREATE A ROOM

10 Create a scene

i Scenes can be created to move your blinds to preset positions.

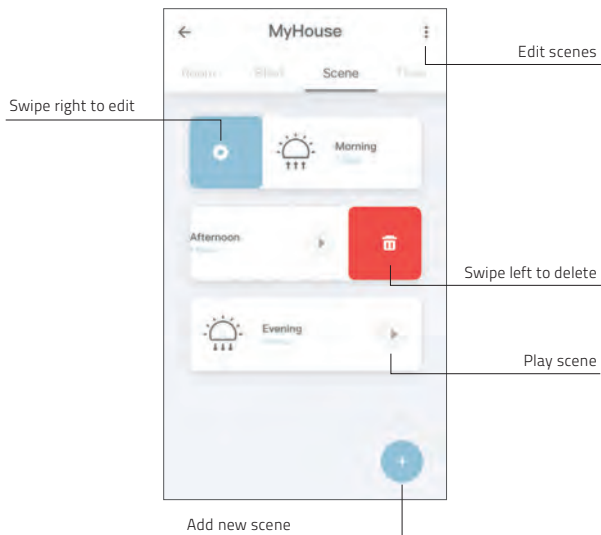

10. CREATE A SCENE

11 Create a timer

i Timers can be created to automate blinds and scenes to make the home seem inhabited.

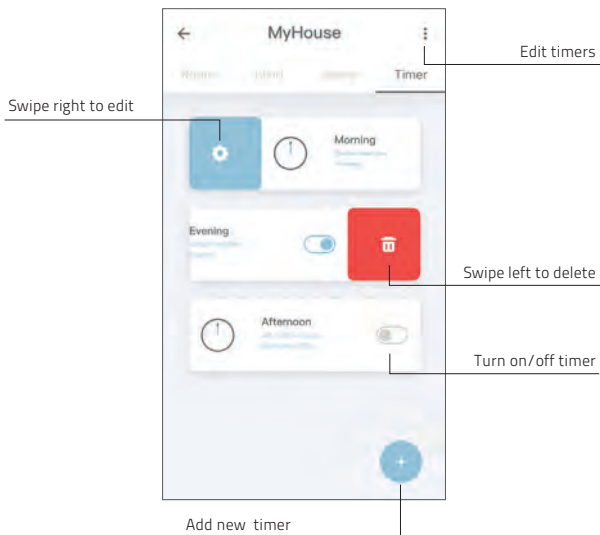

11. CREATE A TIMER

12 Connect to third party

i The MOTION bridge allows to seamlessly connect motorised blinds to smart home applications. Scan the QR code below to discover the third party connections.

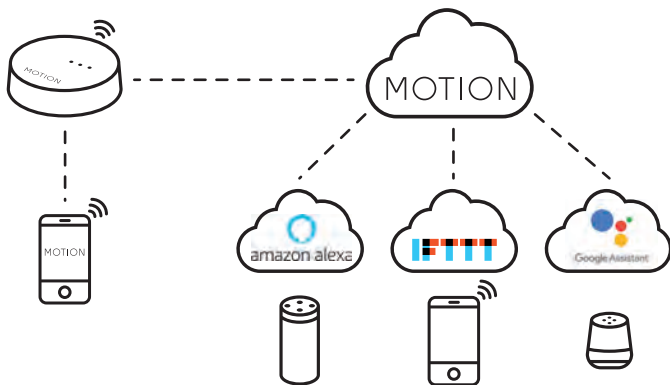

Third party
Discover third party
connections for MOTION
blinds rtube.nl/red1062



12. CONNECT TO THIRD PARTY

13 Frequently Asked Questions

Problem	Cause	Solution
Blind is not responding	Motor battery is empty	Charge the motor. See the manual of your motor
	Radio interference / shielding	Make sure that the bridge/antenna of the motor is out of the way from metal objects
	The distance from the bridge to the motor is too far	Move the bridge closer to the blind
	The bridge is turned off	Power the bridge
Can not pair your bridge	Wrong password	Start the setup wizard again and use the right password. The password is case sensitive
	Router does not give an IP address to the bridge	Press and hold the reset button for 10 seconds. The center LED indicator will be RED. Retry to add the bridge

Select Blinds motors powered by Eve MotionBlinds works with Apple HomeKit technology.

SETUP GUIDE

ROLLER SHADE

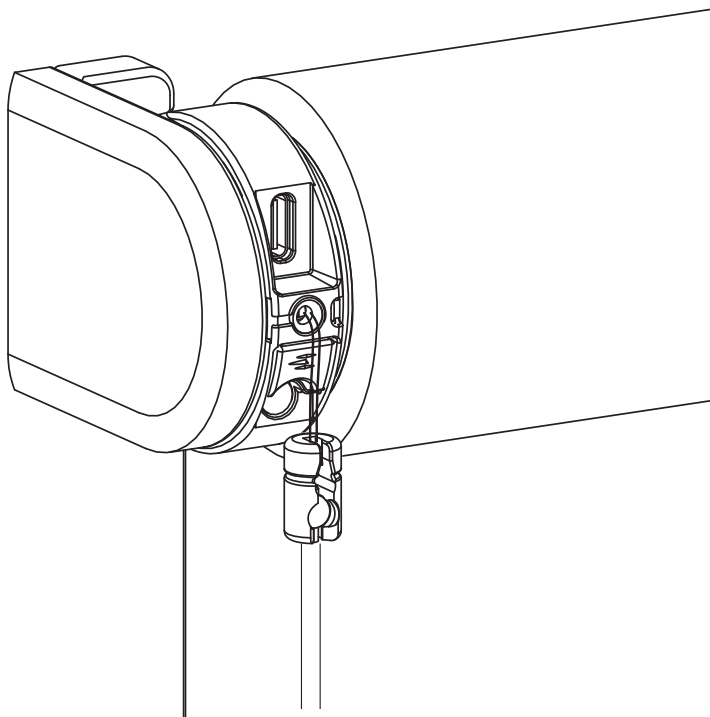

i Buttons and functions

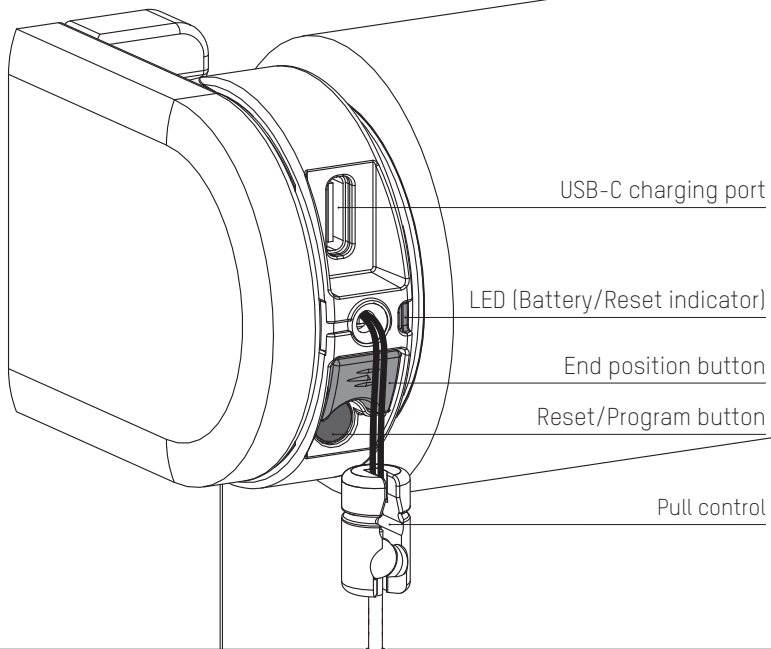

1 Install

Follow the steps in the installation instructions to install shade.

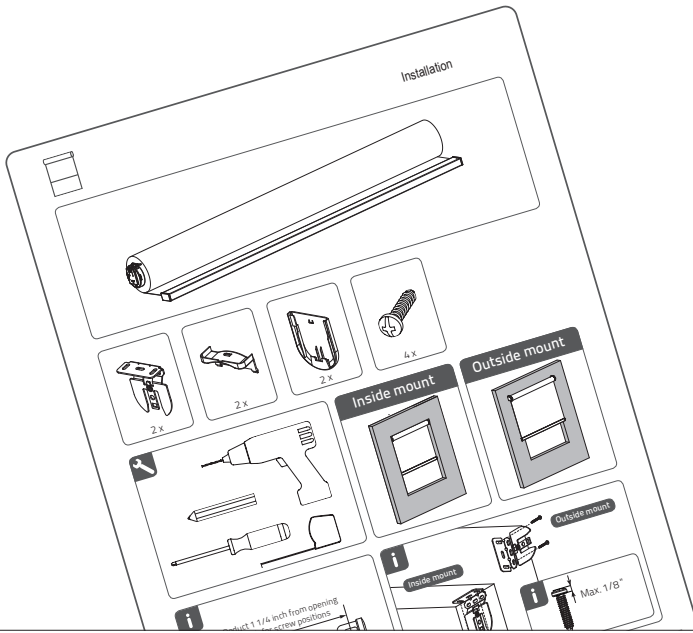

2 Activate

To activate the shade, connect it to a standard USB-C 5V power supply via a USB-C cable. This can be your iPhone's power adapter, for example.

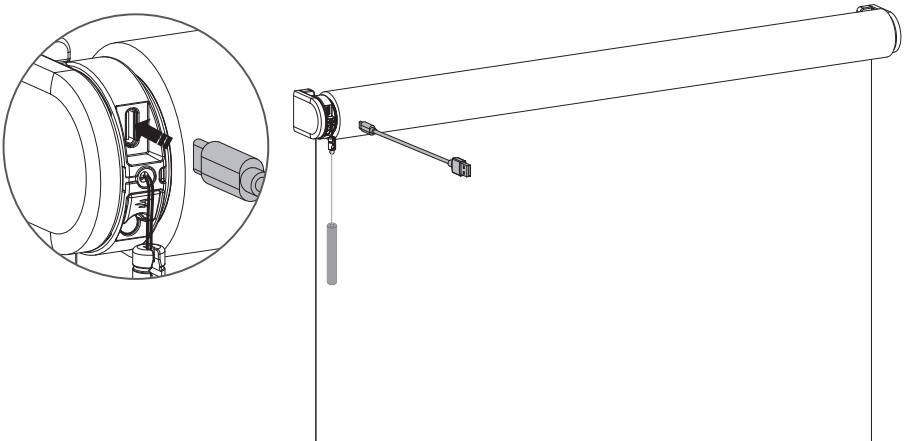

3 Download the Eve app

Download the Eve app from the App Store.

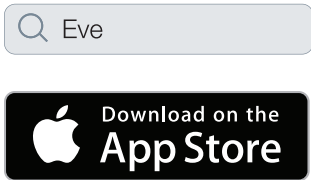

4 Setup the shade

Open the Eve app and tap Add Accessory. Eve will now guide you through the setup process. If you have previously set up an accessory, go to Settings and tap Add Accessory.

The end positions of the **shade**, top and bottom, are pre-programmed. These can be adjusted by following the steps in the app.



Add Accessory

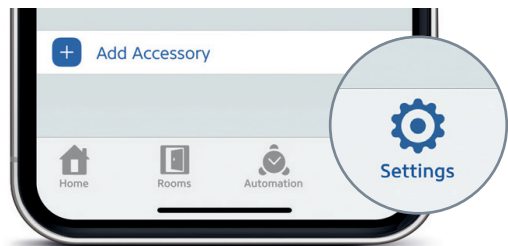

5 Hide the HomeKit Setup Code

Slide the tassel up and rotate a quarter turn to hide the HomeKit Setup Code into the tassel.

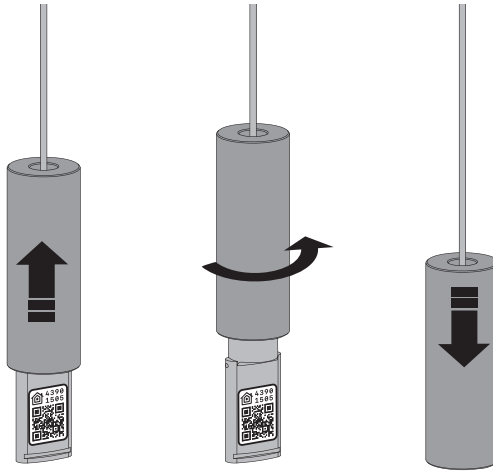

i Recharge the shade

To charge the blind, connect it to a standard USB-C 5V power supply via a USB-C cable. This can be your iPhone's power adapter, for example.

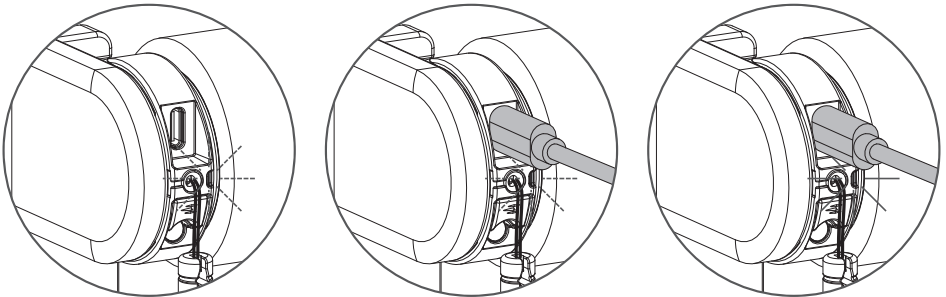

LED light flashes
red during operation;
Charge the battery



LED light flashes
green;
battery is charging



LED light constantly
green;
battery is fully charged