

Solar Shades

POWER TOUCH™ RECHARGEABLE



GETTING STARTED

A few simple tools are required:

- Measuring tape
- Power drill, drill bits
- 1/4" Hex head and/or Phillips driver bit
- #2 Phillips head screwdriver
- Pencil

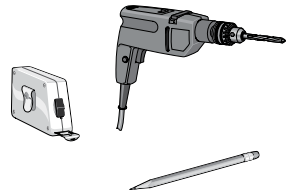

Additional fasteners other than those sent with your shade may be required depending on the mounting surface. Wallboard and plaster require the use of anchors such as expansion or toggle bolts. Brick, tile or stone need special plugs and drill bits. Remember to always pre-drill holes in wood to avoid splitting.

PN: CS5002(W or BLK)
 CS5008 (W or BLK)
 CS5529
 CS5530

Depends on size of shade

PN: CS5402

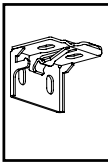

Mounting Bracket

PN: 20201012

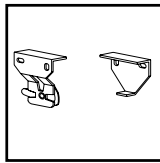

Mounting Brackets for Shades without head rail

PN: CS1000

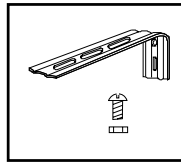

Head rail Extension and Side mount Bracket (optional)

PN: CS1101

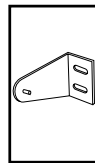

Hold Down Bracket (optional)

PN: CS2000

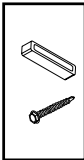

Spacer Block (optional)

PN: CS5199

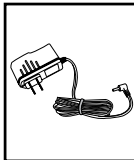

Charger

PN: CWV4024

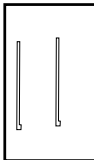

Cable Tie (for No Head Rail Shades)

PN: CS5201

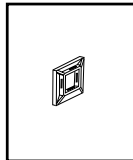

Cable Tie Mounting Base (for No Head Rail Shades)

PN:CS52071

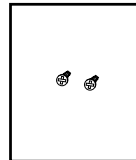

Wand Hanger Screws

STEP 1: BRACKET INSTALLATION

SHADES WITH HEAD RAIL

Shades are shipped with the required number of brackets for proper installation. End brackets should be located approximately 3" from either end. Depending on the width of the shade, additional brackets may be necessary, evenly spaced between the two end brackets.

Using the installation bracket as a template, measure to the center of the bracket and mark the hole locations with a pencil for drilling.

Brackets must be in line and level. Shim brackets on inside mounts if necessary. The head rail must be level for the shade to operate properly.

Shade Width	# of Brackets
Up to 40"	2
>40" - 72"	3
>72" - 84"	4
>84" - 114"	5

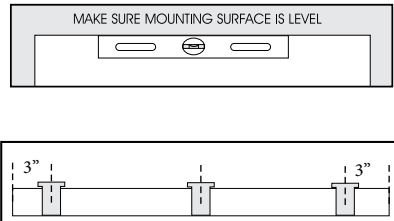

INSIDE MOUNT

The minimum mounting depth for an inside mount is 1".

A minimum of 3 3/4" is needed to fully recess the shade.

Make sure the brackets are level and aligned.

Attach using two screws.

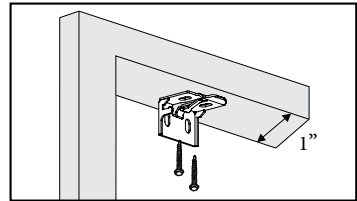

Inside Mount

Shallow Mount - Minimum 1" surface
Flush Mount - Minimum 3 3/4" surface

OUTSIDE MOUNT

The minimum mounting height for outside mounted shades is 1".

Make sure the brackets are level and aligned.

Attach using two screws.

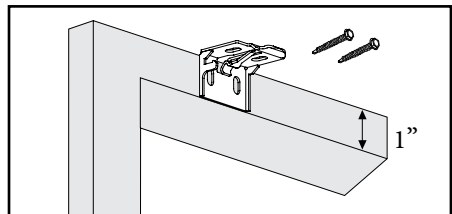

Outside Mount

Minimum 1" surface

SPACER BLOCKS (OPTIONAL)

Each spacer block projects brackets $\frac{3}{8}$ " away from mounting surface. Make sure the brackets are level and aligned.

Attach using two screws. Screws should be long enough to secure the bracket to the mounting surface.

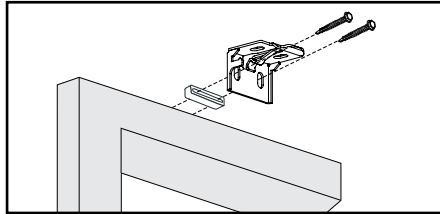

Outside Mount with Spacer Blocks

EXTENSION BRACKETS (OPTIONAL)

Optional extension brackets are used to project the back of the shade up to $2\frac{1}{2}$ " from the mounting surface.

Attach the mounting bracket to the extension bracket with the nut and bolt provided.

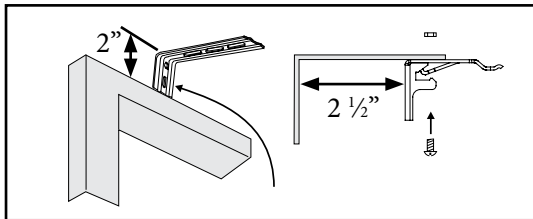

Outside Mount with Extension Brackets

Minimum 2" surface

SIDE MOUNT (OPTIONAL)

Measure from window sill up to desired mounting position on each side of the window frame. Mark position.

Mount side mount brackets on each side of window frame as shown. Make sure to confirm the head rail will sit perfectly level.

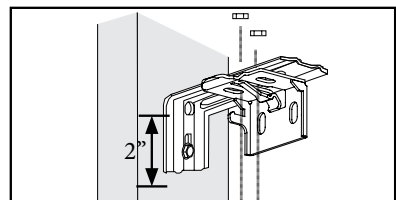

Side Mount

Minimum 2" surface

Once side mount brackets are installed and properly positioned, attach the mounting brackets using the nuts and bolts provided.

SHADES WITH NO HEAD RAIL

The installation brackets are always mounted so that the inner surfaces face each other.

Brackets must be in line and level. Shim brackets on inside mounts if necessary. The head rail must be level for the shade to operate properly.

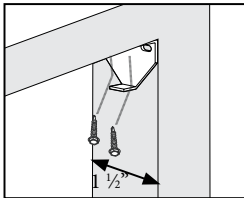
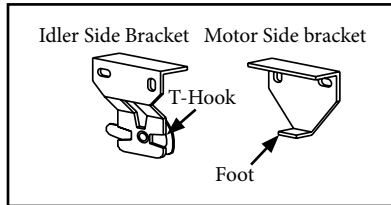

Inside Mount
Minimum 1 1/2" surface

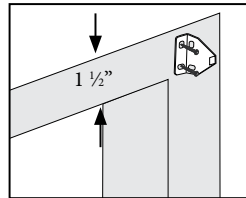

Outside Mount
Minimum 1 1/2" surface

STEP 2: CONNECT WAND

SHADES WITH HEAD RAIL

Plug the control wire into the wand wire . The plugs will only fit together one way. The wires are bundled at the back of the head rail.

SHADES WITH NO HEAD RAIL

While holding wires in the channel of the wand holder, attach the wand holder to the end of the motor with the screws provided, using a #2 phillips head screwdriver. Be sure that the wires are not twisted or pinched.

Plug the wand wires into the motor wires.

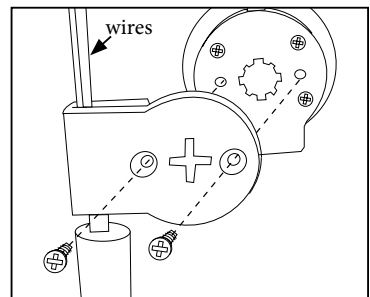

STEP 3: SHADE INSTALLATION

SHADES WITH HEAD RAIL

Center the shade in the window opening and push the head rail into the mounting brackets as shown.

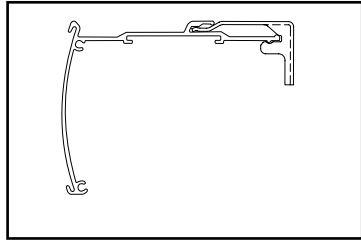
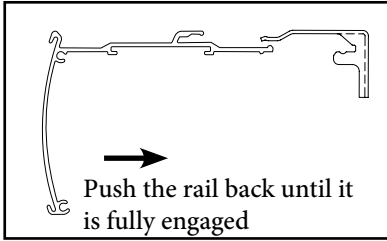

SHADES WITH NO HEAD RAIL

Insert the foot of the motor-side bracket into the slotted center hole of the motor end of the fabric roll.

Set the post of the idler end into the V of the support bracket. Rotate the T-hook on the support bracket to lock in the post and secure the fabric roll.

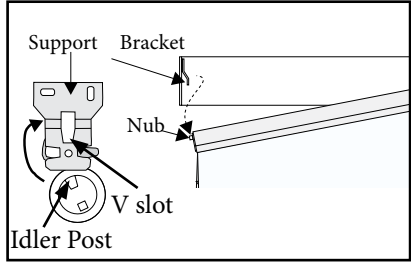

Bundle excess wire and secure with the cable tie mounting base and cable ties.

STEP 4: WIRE MANAGEMENT

Remove the release liner from the mounting base and attach it to the window casing (for inside mount) or wall (for outside mount), in a position that will be hidden from view.

Pull the wires toward the back of the shade.

Bundle the excess wire and secure it to the mounting base with the included cable tie.

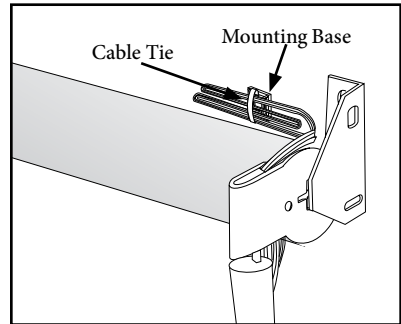

OPERATION

Press the **DOWN** or **UP** button to lower or raise the shade. Press the **STOP/FAVORITE** to stop the shade at the desired position.

To fully raise or lower the shade, simply press the **UP** or **DOWN** button and then release. The shade will automatically stop when it reaches the upper or lower limit. (**See below if the upper or lower limits are not set at the desired positions**)

Note: Upper and lower limits stops are set at the factory. An intermediate, or “favorite” position is not set at the factory. See page 7 for more information.

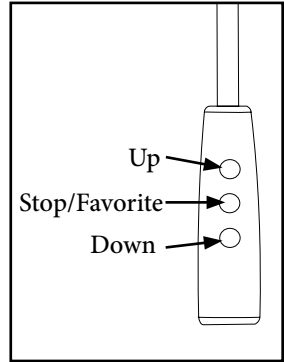

ADJUST MOTOR LIMITS (IF DESIRED)

The upper and lower limits have been set at the factory. If you need to make adjustments to the limits, follow the instructions below.

Press the **SETTING** button on the back of the wand and hold it in until the motor stops beeping. This will clear both the upper and lower factory limits as well as a favorite if one was set.

Set Upper Limit - Press the **UP** button to get the shade close to the desired upper limit and then press the **STOP** button to stop the shade. Tap the **UP** or **DOWN** button to move the shade to the desired position. To save the location, press the **SETTING** button until the motor beeps.

Set Lower Limit - Press the **DOWN** button to get the shade close to the desired lower limit and then press the **STOP** button to stop the shade. Tap the **UP** or **DOWN** button to move the shade to the desired position. To save the location, press the **SETTING** button until the motor beeps.

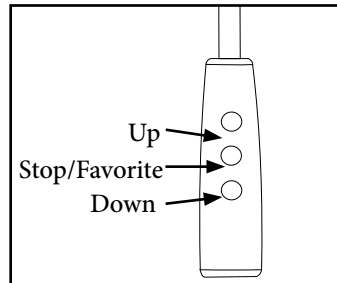
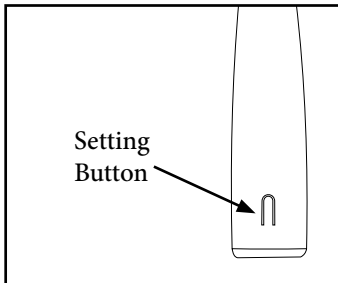

FAVORITE POSITION

SETTING AND USING A FAVORITE POSITION

Use the **UP** or **DOWN** buttons to position the shade at the desired “favorite” position. First press and hold the **SETTING** button on the back of the wand. While holding the **SETTING** button press and hold the **UP** button. Release both buttons when the shade beeps.

With the shade at either the upper or lower limit, simply press the **STOP/FAVORITE** button to bring the shade to the “favorite” position. To go to the “favorite” position from any other location, make sure the shade has been stopped for at least three seconds before pressing the **STOP/FAVORITE** button.

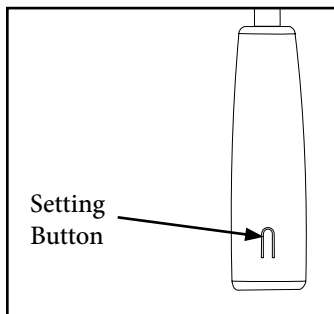

CHANGING A FAVORITE POSITION

Use the **UP** or **DOWN** buttons to position the shade at the new desired “favorite” position. First press and hold the **SETTING** button on the back of the wand. While holding the **SETTING** button press and hold the **UP** button. Release both buttons when the shade beeps.

This establishes a new “favorite” position and erases the old.

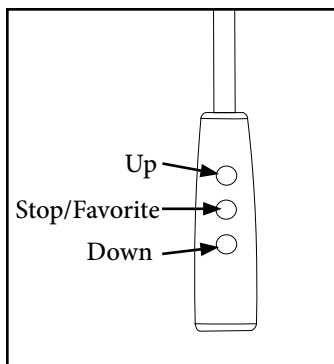

SKEW ADJUSTMENT (IF NECESSARY)

If the shade does not raise evenly, first make sure the mounting brackets are mounted level with each other.

If the shade is level and it still skews, roll the shade all the way down. Prepare a strip of masking tape approximately 5" long.

On the side of the shade opposite of the skewing direction, and as close to the end of the roller as possible, apply the tape with the sticky side facing the fabric. The tape should be placed on the back of the roller, out of sight.

Roll the shade up and check for skewing. If the shade is still skewing, add another strip of tape on top of the first one. If the shade is now skewing in the opposite direction, tear off about 1" of tape from the last strip installed.

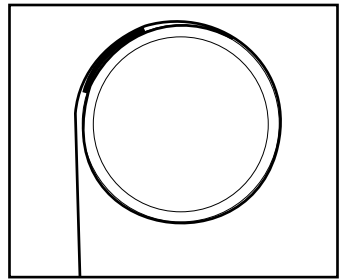
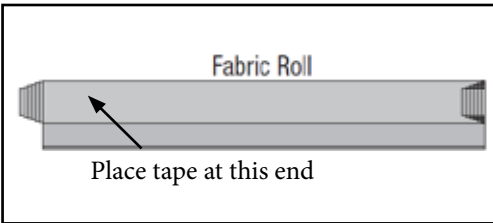

HOLD DOWN BRACKETS (OPTIONAL)

Optional hold down brackets are mounted with the supplied screws.

With the shade at its proper drop, place the pin in each end cap and mark the screw holes.

Make sure the pins are level and aligned.

Raise the shade, then screw the hold down bracket into the mounting surface.

Flex the hold downs out to reinsert the bottom rail.

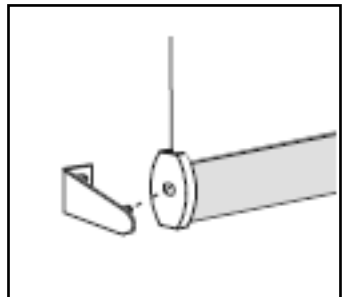

CHARGING THE MOTOR BATTERY

When the shade begins to operate slower than normal, or only beeps when you attempt to operate, it is time to charge the battery.

Plug the 8.4v charger into the port on the wand.

Plug the charger into an electrical outlet.

A red light on the charger indicates that the battery is charging.

Allow the batteries to charge until the light on the charger turns green. A typical charge cycle can take between 4-6 hours.

Do not leave the charger plugged in for more than 24 hours. This could prematurely age the battery.

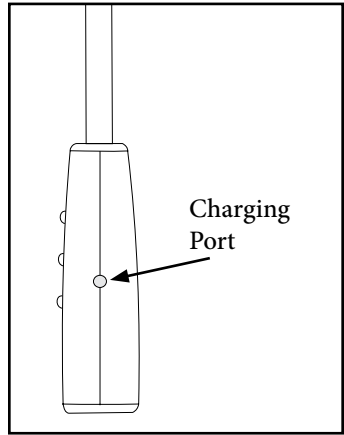

SHADE REMOVAL

If you need to remove your shade, follow the instructions below.

Partially lower the shade and insert a flat head screwdriver as shown.

Twist the screwdriver until the head rail disengages from the bracket.

As you release the brackets, support the head rail to keep it from falling.

For no-head rail simple reverse the installation process.

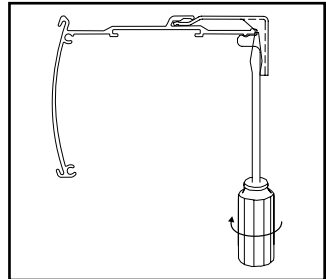

CLEANING AND CARE

The Shade fabric is easy to care for. Regular dusting with a feather duster or vacuum cleaner brush is recommended. Most stains can be blotted with a damp sponge and mild detergent. Before using anything stronger than mild detergent and lukewarm water, test an unobtrusive corner of the shade. If you have any questions, call your dealer for advice.

TROUBLE SHOOTING

PROBLEM	SOLUTION
The motor does not work or runs slowly	Recharge battery.
The shade moves the opposite direction of the control buttons.	Press and hold the SETTING button, then press and hold the STOP button. Hold both until the motor jogs (approx. 10 seconds).

Roller Shades

MOTORIZED SHADE

Simplicity with rechargeable motor



Installation & Care Instructions

152709O
5/3/2022

GETTING STARTED

IMPORTANT: The remote control has **not** been linked to the shades. Install all shades prior to linking the remote. The lower and upper limits have been set at the factory.

A few simple tools are required:

- Measuring tape
- Power drill, drill bits
- ¼” Hex head and/or Phillips driver bit
- Pencil

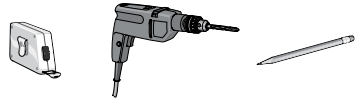

Additional fasteners other than those sent with your shade may be required depending on the mounting surface. Wallboard and plaster require the use of anchors such as expansion or toggle bolts. Brick, tile or stone need special plugs and drill bits. Remember to always pre-drill holes in wood to avoid splitting.

PN: CKIT007(W or BLK)
 CKIT008(W or BLK)
 CKIT042
 CKIT043

Depends on size of shade

PN: CKIT013Q2

PN: CKIT013Q3

PN: KIT2011

PN: KIT2012

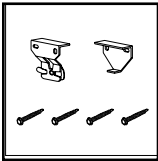

Mounting Brackets for Shades without head rail

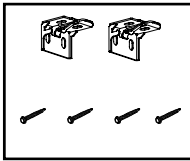

Mounting Brackets for Shades with Head Rail - 2 pack

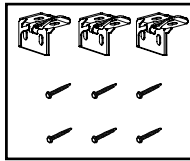

Mounting Brackets for Shades with Head Rail - 3 pack

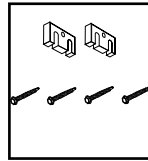

Spacer Block (optional) - 2 pack

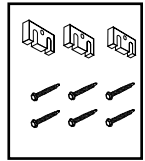

Spacer Block (optional) - 3 pack

PN: CKIT002

PN: CKIT028

PN: KIT2013

PN: KIT2014

PN: CKIT037

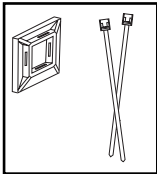

Tie Wrap Kit (no-headrail shades only)

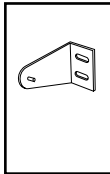

Hold Down Bracket (optional)

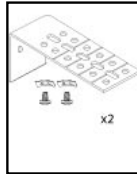

Head Rail Extension and Side Mount Bracket - 2 pack

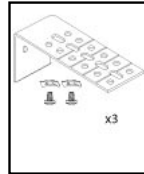

Head Rail Extension and Side Mount Bracket - 3 pack

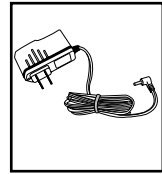

Charger

STEP 1: BRACKET INSTALLATION

Important: If a solar recharge unit is being installed, read the solar panel booklet prior to installing mounting brackets.

SHADES WITH HEAD RAIL

Shades are shipped with the required number of brackets for proper installation. End brackets should be located approximately 3" from either end. Depending on the width of the shade, additional brackets may be necessary, evenly spaced between the two end brackets.

Using the installation bracket as a template, measure to the edge of the bracket and mark the hole locations with a pencil for drilling.

Brackets must be in line and level. Shim brackets on inside mounts if necessary. The head rail must be level for the shade to operate properly.

Shade Width	# of Brackets
Up to 40"	2
>40" - 72"	3
>72" - 84"	4
>84" and up	5

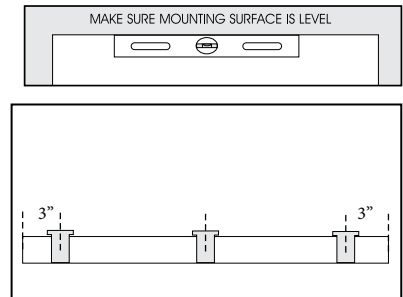

INSIDE MOUNT

The minimum mounting depth for an inside mount is 1".

A minimum of 3 3/4" is needed to fully recess the shade.

Make sure the brackets are level and aligned.

Attach using two screws.

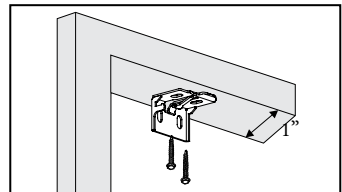

Inside Mount

Shallow Mount - Minimum 1" surface
Flush Mount - Minimum 3 3/4" surface

OUTSIDE MOUNT

The minimum mounting height for outside mounted shades is 1".

Make sure the brackets are level and aligned.

Attach using two screws.

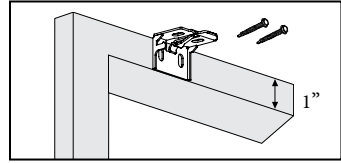

Outside Mount
Minimum 1" surface

SPACER BLOCKS (OPTIONAL)

Each spacer block projects brackets $\frac{3}{8}$ " away from mounting surface.

Make sure the brackets are level and aligned.

Attach using two screws. Screws should be long enough to secure the bracket to the mounting surface.

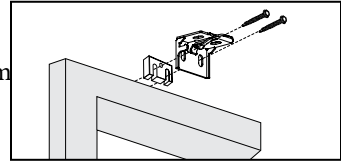

Outside Mount with Spacer Blocks

EXTENSION BRACKETS (OPTIONAL)

Optional extension brackets are used to project the back of the shade up to $2\frac{1}{2}$ " from the mounting surface.

Attach the mounting bracket to the extension bracket with the nut and bolt provided.

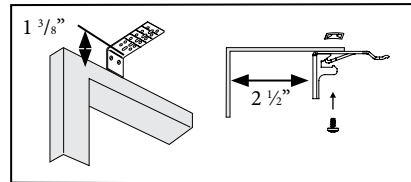

Outside Mount with Extension Brackets
Minimum $1\frac{3}{8}$ " surface

SIDE MOUNT (OPTIONAL)

Measure from window sill up to desired mounting position on each side of the window frame. Mark position.

Mount side mount brackets on each side of window frame as shown. Make sure to confirm the head rail will sit perfectly level.

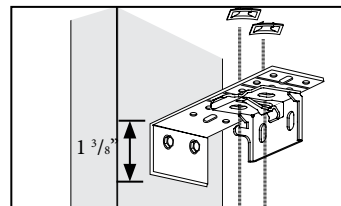

Side Mount
Minimum $1\frac{3}{8}$ " surface

Once side mount brackets are installed and properly positioned, attach the mounting brackets using the nuts and bolts provided.

SHADES WITH NO HEAD RAIL

The installation brackets are always mounted so that the inner surfaces face each other.

Brackets must be in line and level. Shim brackets on inside mounts if necessary. The head rail must be level for the shade to operate properly.

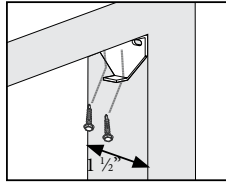
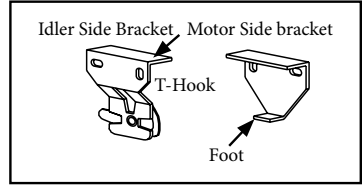

Inside Mount

Minimum 1 1/2" surface

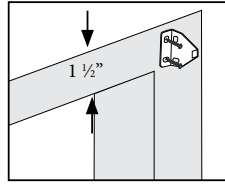

Outside Mount

Minimum 1 1/2" surface

STEP 2: SHADE INSTALLATION

SHADES WITH HEAD RAIL

Center the shade in the window opening and push the head rail into the mounting brackets as shown.

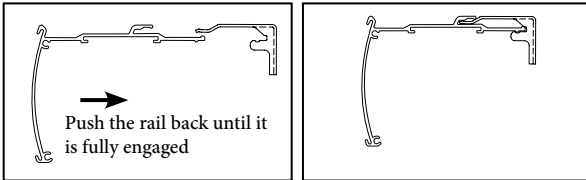

SHADES WITH NO HEAD RAIL

Once the brackets are secured and level, the fabric roll can be inserted. Make sure your hands are clean to avoid soiling the fabric.

Insert the foot of the motor-side bracket into the slotted center hole of the motor end of the fabric roll. The antenna wire should be positioned so that it goes up. This will provide easy access to the setting button and recharge port.

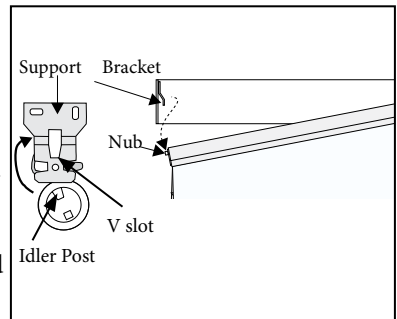

Set the post of the idler end into the V of the support bracket. Rotate the T-hook on the support bracket to lock in the post and secure the fabric roll.

STEP 3: LINK REMOTE

Important: Please read through this section completely before beginning.

This remote control has 14 channels. Before linking the remote, determine which shade(s) you want on which channel. All shades linked to a remote will also automatically be programmed to the “ALL” channel.

The 14 Channel remote may also be used to operate top down-bottom up cellular shades. **You can not mix a standard bottom up only shade and a TD/BU shade on the same channel.**

Remove plastic film from the front of the remote. Remove screw from the back of the remote and slide cover down and off. Do not replace cover until shades have been linked and limits have been adjusted (if necessary). If battery is not already installed in the remote follow the instructions on page 14.

1. Select the channel that you want to link the shades to, using the **CHANNEL** selector button. The button will scroll through channels in ascending order only. The remote will go back to channel 1 after channel AL. See next page to disable unused channels.

2. Make sure the On/Off switch on the motor is set to “ON”

3. Confirm that the channel selected is set for bottom up only shades by looking to see if a number 1, 2 or 3 shows in the left of the display. If a number is shown, deactivate the Top Down/Bottom Up function for that channel by pressing the **RAIL SELECTOR** and **DOWN** buttons at the same time until the rail selector number disappears from the left side of the screen.

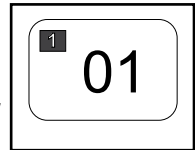

4. Press the **SETTING** button on the motor until it beeps/jogs, then release. The motor will make 4 fast beeps followed by 5 long beeps. Press the **CONFIRM** button on the remote anytime during the series of long beeps. It must be pressed before the last long beep. The motor will beep and jog confirming that the shade has been linked.

5. Repeat steps 1-4 to link remaining shades to the rest of the channels.

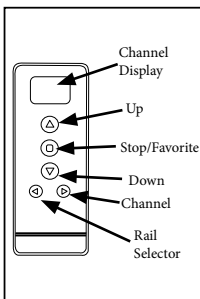
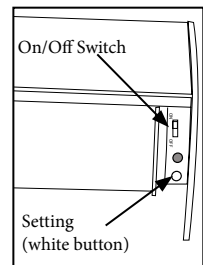

Front

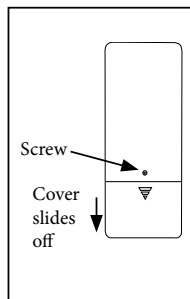

Back (cover on)

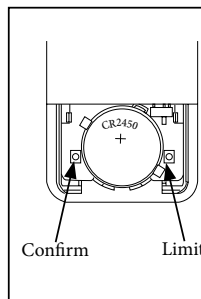

Back (cover off)

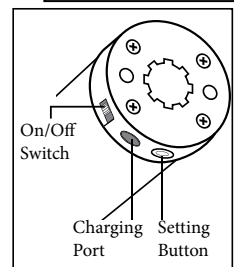

OPERATION

Select the desired channel with the **CHANNEL** button.

Tapping the **UP** or **DOWN** buttons for less than 2 seconds will move the shade in short steps. Holding the **UP** or **DOWN** buttons down for more than 2 seconds before releasing will operate the shade in the faster standard speed. Press the **UP** or **DOWN** buttons to raise or lower the shade.

Press the **STOP** button to stop the shade anywhere along the travel.

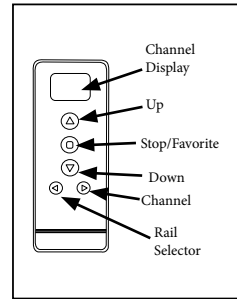

Remote (front)

TO DE-ACTIVATE THE JOG FUNCTION

The remote comes pre-set with the jogging function activated. Follow the directions below if you would like to de-activate it.

Carefully remove the back cover of the remote.

Slide the switch from BY to BF.

Replace the back cover.

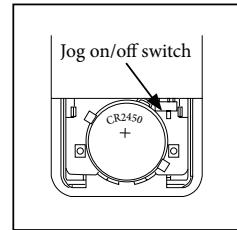

DISABLING EXCESS CHANNELS

The 14 channel remote has the option of turning off unused channels, making channel selection easier.

Press and hold both **UP** and **DOWN** buttons for 3 seconds until 00 Channel displays. Release the buttons and the 00 will start to flash.

Press the **UP** or **DOWN** button to select the required number of channels (between 1-14).

Press and hold the **CHANNEL** and **RAIL** selector buttons at the same time to confirm selection. The display will go back to channel 01.

Follow the same process if you need to re-add channels.

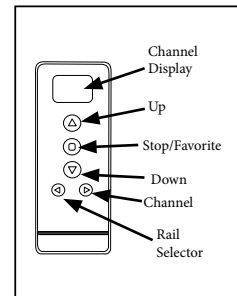

Remote (front)

ANTENNA RESTRAINT- NO HEADRAIL SHADES

Position the antenna so that it will not get caught in the roller during operation.

Remove the release liner from the back of the tie wrap mounting base and adhere it near the antenna.

Use the tie wrap to hold the antenna in place.

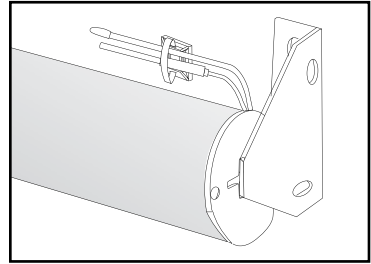

ADJUST MOTOR LIMITS (IF DESIRED)

The lower and upper limits have been set at the factory. If you need to make adjustments to the limits, follow the instructions below.

Please Note: When clearing the factory set limits, both the upper and lower limits will need to be reset.

Use the **CHANNEL** buttons to select the channel for the shade that needs to be adjusted. Then follow the directions below.

If there is only a single shade on the channel, proceed to setting limits on the next page.

If there is more than one shade on the channel, all other shades on that channel will need to be disabled.

To disable a shade, set the ON/OFF switch on the motor to the “OFF” position.

Follow the limit setting instructions on next page and then turn the other shades back on by setting the ON/OFF switch on the motor to the “ON” position.

LOWER LIMIT

Hold the **LIMIT** button until the shade starts jogging/beeping.

Use the **DOWN** button to lower the shade. Press stop when the shade is near the desired lower limit.

Use the **UP** and **DOWN** buttons to adjust the length more accurately.

Hold the **CONFIRM** button until the shade jogs/beeps. This locks in the lower limit.

UPPER LIMIT

Use the **UP** button to raise the shade. Press stop when the shade is near the desired upper limit.

Use the **UP** and **DOWN** buttons to adjust the upper limit more accurately.

Hold the **CONFIRM** button until the shade jogs/beeps. This locks in the upper limit.

Note: If you also desire to set a favorite position you should do so prior to moving the switch back to the “ON” position for shades that share that channel. See the next page for setting favorites.

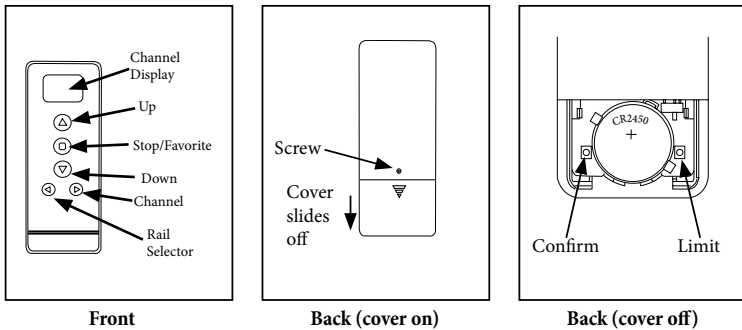

FAVORITE POSITION

If there is only a single shade on the channel proceed to setting favorites below.

If there is more than one shade on the channel, all other shades on that channel will need to be disabled.

To disable a shade, set the ON/OFF switch on the motor to the “OFF” position.

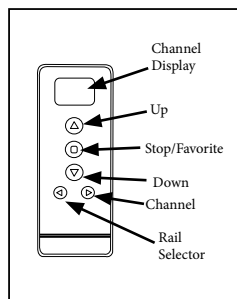

SETTING A FAVORITE POSITION

Use the **UP** or **DOWN** buttons to position the shade at the desired “favorite” position. While holding the **LIMIT** button, quickly press and hold the **UP** button. Release both buttons when the shade jogs/beeps.

When complete, turn the other shades back on by setting the ON/OFF switch on the motor to the “ON” position.

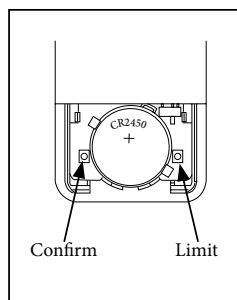

USING A FAVORITE POSITION

With the shade at either the upper or lower limit, simply press the **STOP/FAVORITE** button to bring the shade to the “favorite” position. To go to the “favorite” position from any other location, make sure the shade has been stopped for at least three seconds before pressing the **STOP/FAVORITE** button.

CHANGING A FAVORITE POSITION

If there is only a single shade on the channel proceed to changing favorites below.

If there is more than one shade on the channel, the other shades on that channel will need to be disabled.

To disable a shade, set the ON/OFF switch on the motor to the “OFF” position.

Use the **UP** or **DOWN** buttons to position the shade at the desired “favorite” position. While holding the **LIMIT** button, quickly press and hold the **UP** button. Release both buttons when the shade jogs/beeps.

To erase a “favorite” position, bring the shade to the **upper** limit. Press and hold the **LIMIT** button on the back of the remote, then press and hold the **UP** button. Release both buttons when the shade jogs/beeps.

When complete, turn the other shades back on by setting the ON/OFF switch on the motor to the “ON” position.

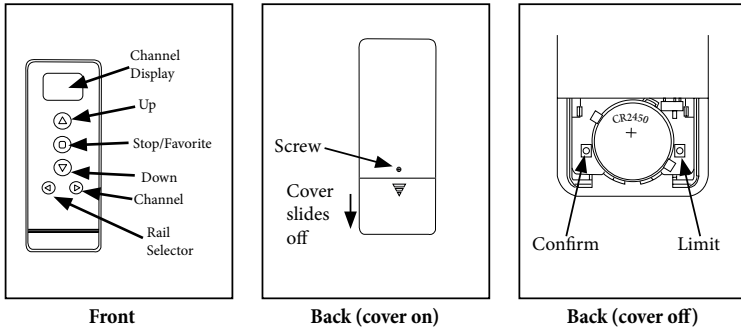

ADVANCED PROGRAMMING

REPLACE ORIGINAL REMOTE, ADD ADDITIONAL REMOTE OR ADD SHADE TO AN ADDITIONAL CHANNEL

1. Select the channel that you want to program using the **CHANNEL** selector button.

2. Press the **SETTING** button on the motor until it beeps/jogs, then release. The motor will make 4 fast beeps followed by 5 long beeps. Press the **CONFIRM** button on the remote anytime during the series of long beeps. It must be pressed before the last long beep. The motor will beep and jog confirming that the shade has been linked.

3. Repeat steps 1-2 to program the rest of the channels on a multi-channel remote.

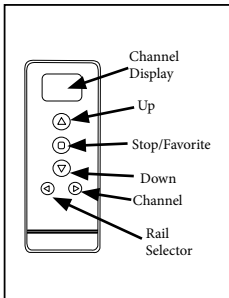
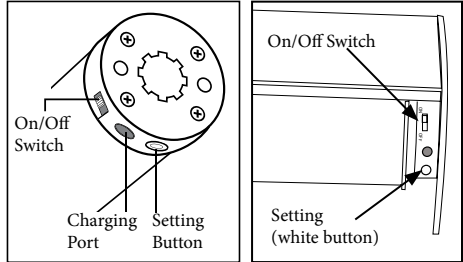

Front

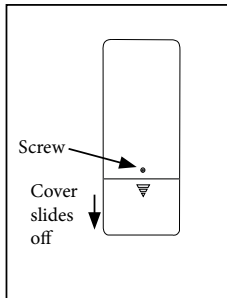

Back (cover on)

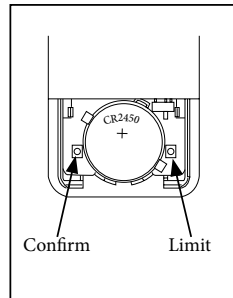

Back (cover off)

REMOVE A SHADE FROM A REMOTE OR CHANNEL AND LINK IT TO A DIFFERENT REMOTE OR CHANNEL

Press and release the **CONFIRM** button. The shade will jog and beep one time. Continue to press and release until the shade jogs and beeps several times in a row.

The original remote or channels have been unlinked.

Link the motor to the new remote or channel

1. Follow the steps for replacing the remote on page 11.

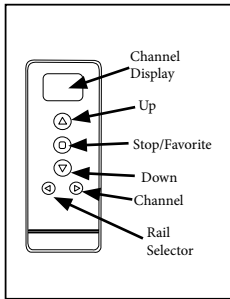

Front

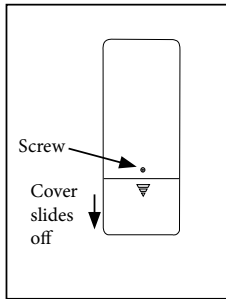

Back (cover on)

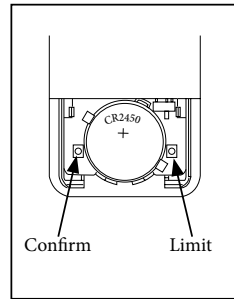

Back (cover off)

SKREW ADJUSTMENT (IF NECESSARY)

If the shade does not raise evenly, first make sure the mounting brackets are mounted level with each other.

If the shade is level and it still skews, roll the shade all the way down. Prepare a strip of masking tape approximately 5" long.

On the side of the shade opposite of the skewing direction, and as close to the end of the roller as possible, apply the tape with the sticky side facing the fabric. The tape should be placed on the back of the roller, out of sight.

Roll the shade up and check for skewing. If the shade is still skewing, add another strip of tape on top of the first one. If the shade is now skewing in the opposite direction, tear off about 1" of tape from the last strip installed.

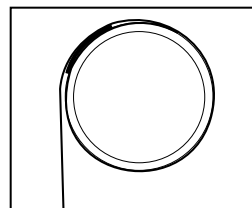
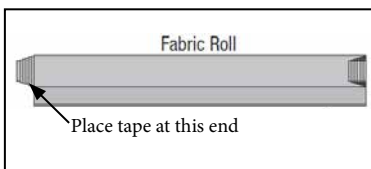

HOLD DOWN BRACKETS (OPTIONAL)

Optional hold down brackets are mounted with the supplied screws.

With the shade at its proper drop, place the pin of each hold down into the hole in each end cap and mark the screw holes.

Make sure the pins are level and aligned.

Raise the shade, then screw the hold down bracket into the mounting surface.

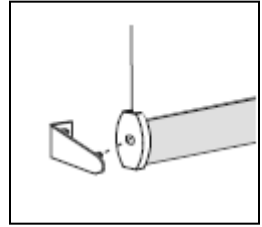

CHARGING THE MOTOR

When the shade begins to operate slower than normal it is time to charge the motor.

Plug the 8.4v charger into the port on the motor.

Plug the charger into an electrical outlet.

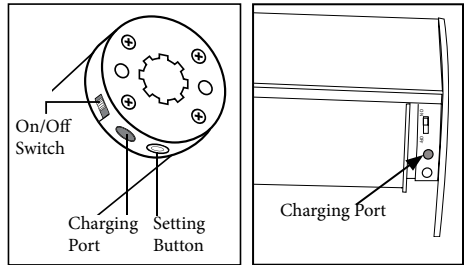

A red light on the charger indicates that the battery is charging.

Allow the batteries to charge until the light on the charger turns green. A typical charge cycle can take between 4-6 hours.

Do not leave the charger plugged in for more than 24 hours. This could prematurely age the battery.

REPLACING THE BATTERY IN THE REMOTE

Remove the screw from the back of the remote and slide the cover down/off.

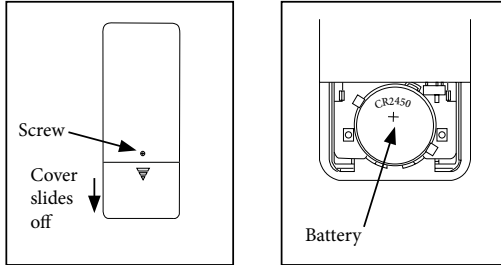

Insert the new battery (CR2450 lithium) into the battery tray so that the writing is facing up (positive up). Slide the cover back onto the remote and replace the screw.

SHADE REMOVAL

If you need to remove your shade, follow the instructions below.

Partially lower the shade and insert a flat head screwdriver as shown.

Twist the screwdriver until the head rail disengages from the bracket.

As you release the brackets, support the head rail to keep it from falling.

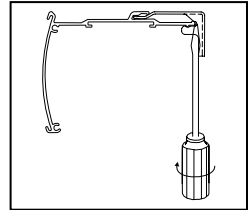

CLEANING AND CARE

The shade fabric is easy to care for. Regular dusting with a feather duster or vacuum cleaner brush is recommended. Most stains can be blotted with a damp sponge and mild detergent. Before using anything stronger than mild detergent and lukewarm water, test an unobtrusive corner of the shade. If you have any questions, call your dealer for advice.

TROUBLESHOOTING

PROBLEM	SOLUTION
The motor does not work or runs slow	Recharge motor
The motor continues to run in one direction	The limit setting was unsuccessful and needs to be reset
The indicator light on the remote does not shine or the remote-controlling range becomes shorter	Replace the battery in the remote (CR2450)

Supplier's Declaration of Conformity 47 CFR § 2.1077 Compliance Information

Unique Identifier: 1032832 (BF-415A), 1032833(BF-415AB)

Responsible Party - US Contact Information

Window Covering Manufacturer
21 Elm Street
Maplewood, NY
12189

Phone #: (800) 843-4151

FCC Compliance Statement:

This device complies with Part 15 of the FCC Rules. Operation is subject to following two conditions (1) This device may not cause harmful interference, and (2) this device must accept any interference received, including interference that may cause undesired operation.

CAUTION: Changes or modifications not expressly approved by the party responsible for compliance could void the users authority to operate the equipment.