

Window Shadings

Installation, Operation and Care
Instructions



PowerWand™ Motorization

Getting Started:

Product View 2

Installation:

Tools and Fasteners Needed 3
Installation Overview 4
STEP 1 — Install the Brackets..... 4
 Mount the Installation Brackets — Inside Mount 5
 Mount the Installation Brackets — Outside Mount 6
 Mount the Installation Brackets — End Mount 9
STEP 2 — Install the Shading..... 10
Attach Magnetic Hold-Down Brackets (Optional) 11

Operation:

Operate the Shading 12
Adjusting Motor Limits / Setting a Favorites 12
Charging the Motor Battery..... 13
Troubleshooting 14

Care:

Cleaning Procedures 15

Warranty 16

PRODUCT OVERVIEW

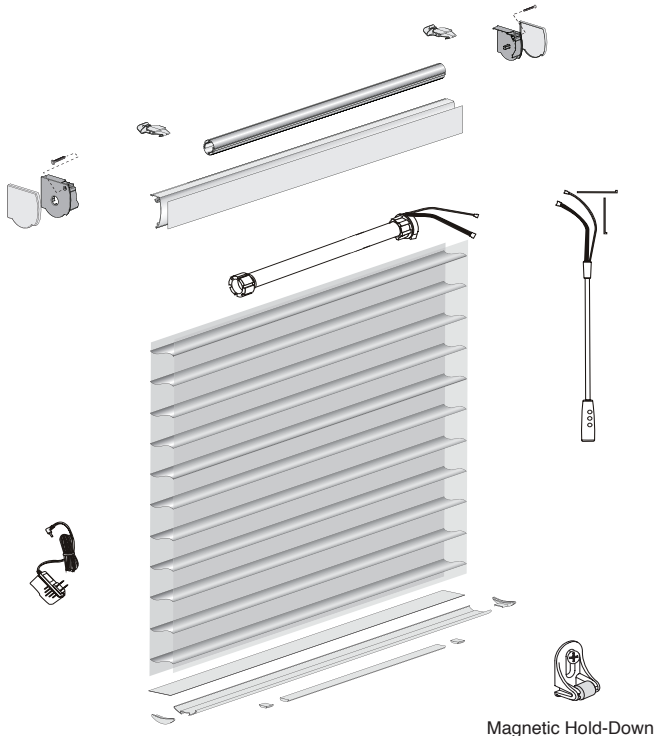

Magnetic Hold-Down

INSTALLATION

Thank you for purchasing Window Shadings. With proper installation, operation, and care, your new shadings will provide years of beauty and performance. Please thoroughly review this instruction booklet before beginning the installation. For information regarding operation and programming, refer to the guide included with your remote control.

Tools and Fasteners Needed

- Flat blade and Phillips screwdrivers
- Level (laser level is recommended)
- Measuring tape and pencil
- Pliers
- Power drill, $\frac{3}{32}$ " drill bit, and $\frac{1}{4}$ " hex driver
- Scissors (heavy-duty)

In addition, you will need fasteners designed to work with your specific mounting surface(s).

- **#6 Hex Head Screws (Provided).** Two $1\frac{1}{2}$ " screws are provided per installation bracket.
- **Longer Hex Head Screws (Not Provided).** If using spacer blocks, use #6 screws long enough for a secure attachment.
- **Speed Nuts and Screws (Provided).** Extension brackets come with screws and speed nuts.
- **Drywall Anchors (Not Provided).** Use drywall anchors when mounting into drywall.



#6 x $1\frac{1}{2}$ "
Hex Head Screw
(Provided)



Longer #6 Hex Head Screw
for Use with Spacer Blocks
(Not Provided)



Speed Nut
and Screw
(Two Provided with
Each Extension Bracket)

Importance of Limit Stops on Window Shadings

Limit stops serve as the upper travel limit for the bottom rail, preventing it from rotating around the fabric roll. Limit stops are located 6" from the ends of the headrail or are centered on shadings less than 36" wide.

When a shading is made, the limit stops are adjusted according to the size of the fabric roll. Occasionally, this adjustment changes during shipping or installation. If this happens, problems can be fixed by readjusting the limit stops. See the Troubleshooting section if shading operation is difficult or if the bottom rail rotates around the fabric roll. Shown below are the four possible positions of limit stops for large to small fabric rolls.

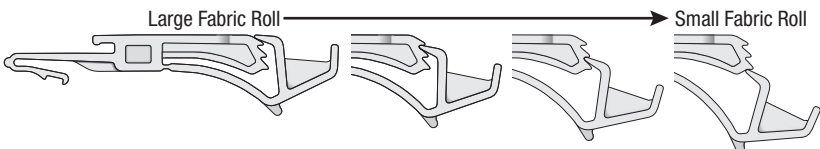

Installation Overview

To install your shading, you will need to perform the following steps:

STEP 1: Install the Brackets

STEP 2: Install the Shading

STEP 1 — Install the Brackets

- Your order will include the correct number of installation brackets for your shading width, as shown in the table below.
- Shading orders may also include spacer blocks or extension brackets, if they were specified for added clearance.
 - Extension brackets are used for end mount shadings, as well.

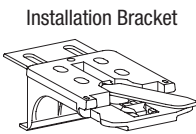

Panel Width	Brackets
14" – 36"	2
36 ¹ / ₈ " – 79"	3
79 ¹ / ₈ " – 96"	4
96 ¹ / ₈ " – 120"	5

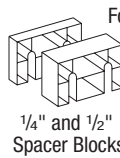

For Added Clearance

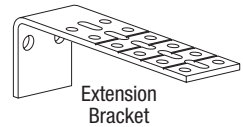

Mounting Types and Window Terminology

If the installation brackets are mounted correctly, the rest of the installation process follows easily. To prepare for this important first step, review the mounting types and basic window terminology illustrated below.

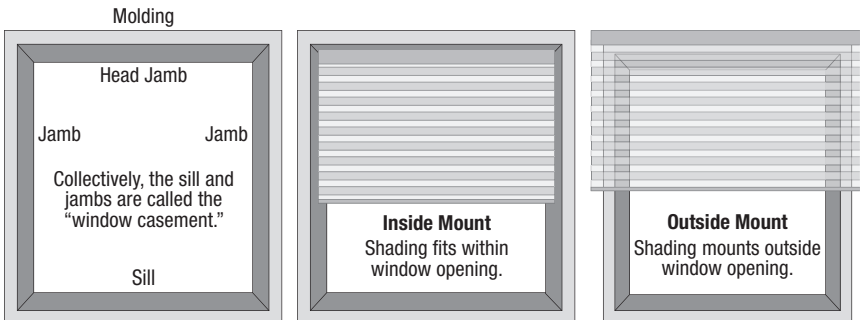

- Refer to the appropriate page below based on your order:

- **Inside Mount — Page 5**
- **Outside Mount — Page 6**
- **End Mount — Page 9**

Mount the Installation Brackets — Inside Mount

Prepare the Installation Brackets

- **If using the optional back cover:** Use pliers or heavy duty scissors to remove both the top and bottom tabs on the installation brackets.
 - Snap the prongs on the back cover brackets into the holes on the back of the installation brackets.

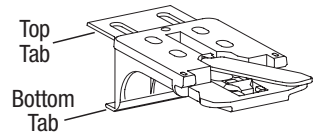

NOTE: Save these tabs once removed. They may be used as shims, if necessary.

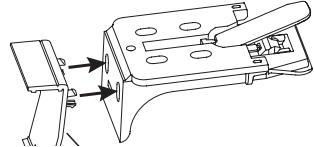

Mount the Installation Brackets

- Measure and mark end bracket locations 2" in from each jamb.
 - If more than two installation brackets are required (see table on page 3), mark the location of additional bracket(s) spaced evenly between the two end bracket locations. Mount into wood whenever possible.

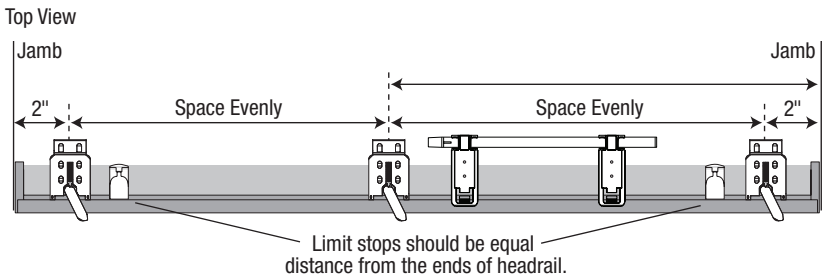

- Center the brackets on your marks, then mark the screw hole locations.
 - Use the rear set of holes with shallow mounting depths. Use the front set of holes when depth permits.

IMPORTANT: The front edges of the installation brackets must be level and aligned.

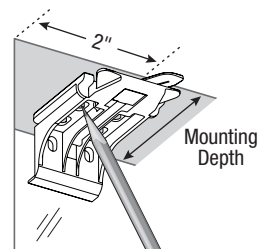

WARNING: Failure to properly align the brackets could result in the headrail releasing from the brackets.

- Drill the screw holes using a $\frac{3}{32}$ " drill bit.

CAUTION: Use drywall anchors when mounting into drywall.

- Use a level to check that the mounting surface is level. Shim the brackets, if necessary. (Use the top tab that was removed from the brackets.)
- Attach the installation brackets using the screws provided.

IMPORTANT: Do not overtighten the screws. Check to ensure the lever can be moved easily side to side. If not, loosen the screws in one-eighth turn increments until the lever can be moved easily.

IMPORTANT: The front edges of the installation brackets must be level and aligned to each other.

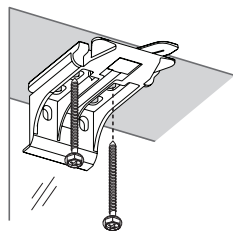

Proceed to “STEP 2 — Install the Shading” on page 10.

Mount the Installation Brackets — Outside Mount

Prepare the Installation Brackets

- Use pliers or heavy duty scissors to remove both the top and bottom tabs on the installation brackets.

NOTE: Save these tabs once removed. They may be used as shims, if necessary.

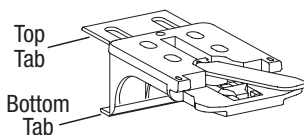

Mount the Installation Brackets

- Center the headrail over the window opening at the desired height. Use a pencil to lightly mark each end of the headrail.
 - Alternatively, measure the width of the headrail and use that width to mark the headrail end points over the window opening.
- Mark 2" in from each of the headrail end marks.
 - If more than two installation brackets came with your order, space additional bracket(s) evenly between the two end brackets and mark their location. Mount into wood whenever possible.

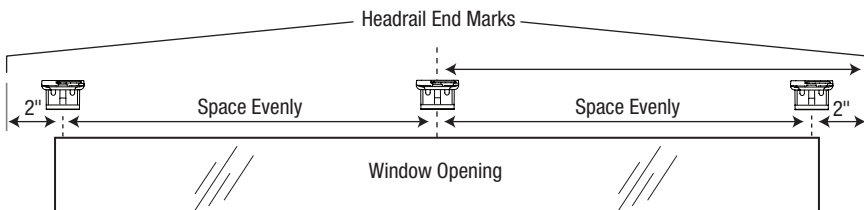

- Center the installation brackets or extension brackets on your marks and mark where to drill the screw holes.
- A minimum 1 1/8" flat vertical surface is required for the installation brackets. Extension brackets require 1 1/4".
- The tops of the installation brackets or extension brackets should be at the desired height. The brackets should be level and aligned.

CAUTION: The rear of the brackets must be flush against a flat mounting surface. Do not mount brackets on curved molding.

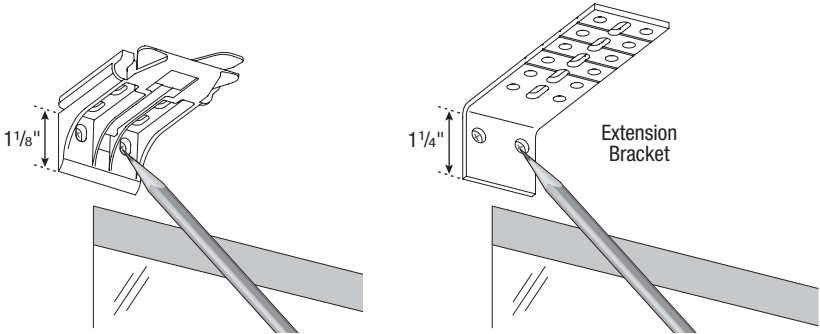

- Drill the screw holes using a 3/32" drill bit.

CAUTION: Use drywall anchors when mounting into drywall.

- Attach the installation or extension brackets using the screws provided.

- The solid side of the spacer blocks faces the mounting surface.

IMPORTANT: The tops of the installation brackets or extension brackets must be level with their front edges aligned.

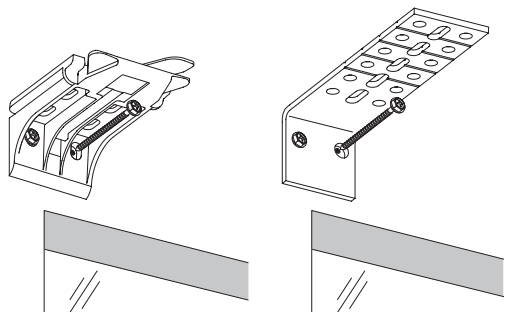
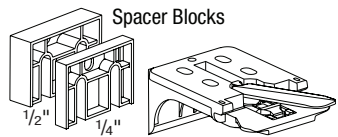

- If using spacer blocks, attach the spacer block(s) and installation bracket to a flat vertical mounting surface with #6 screws long enough for a secure installation.

IMPORTANT: Do not add more than 1 1/2" of clearance using spacer blocks.

IMPORTANT: The tops of the installation brackets must be level with the front edges aligned.

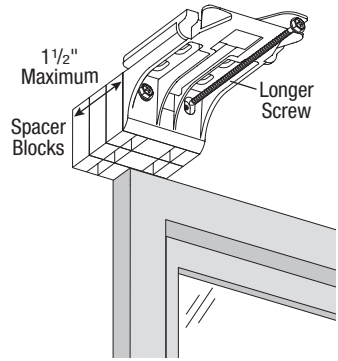

- If using extension brackets, attach an installation bracket to the underside of each extension bracket using the speed nuts and screws provided.

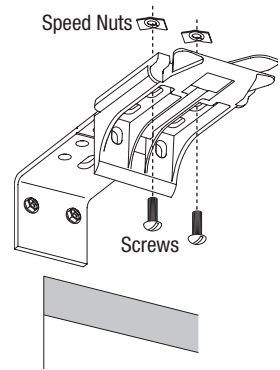

Proceed to "STEP 2 — Install the Shading" on page 10.

Mount the Installation Brackets — End Mount

End mount the headrail when conventional mounting techniques will not work — for example, in an arched window opening.

■ **If using the optional back cover:** Use pliers or heavy duty scissors to remove both the top and bottom tabs on the installation brackets.

- Snap the prongs on the back cover brackets into the holes on the back of the installation brackets.

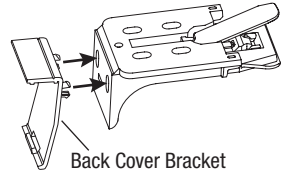
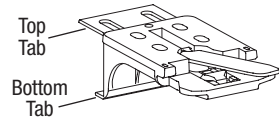

■ Mount the extension brackets on a surface at least 1 1/4" wide.

- Add 1/4" to the minimum depth if using the optional back cover.

■ Attach the installation brackets to the extension brackets using the provided screws and speed nuts.

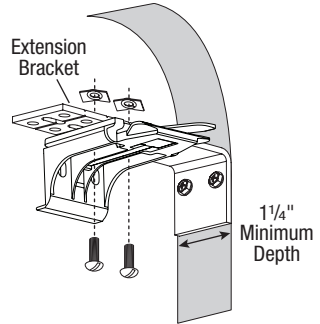

WARNING: To end mount shadings into a surface other than a secure wall stud, use medium to heavy-duty wall anchors (not provided) matched to the wall thickness. Failure to mount the brackets securely may result in injury or property damage.

Proceed to “STEP 2 — Install the Shading” on page 10.

STEP 2 — Install the Shading

- Peel back the protective covering from the top and endcaps of the headrail. (If ordered with fabric covered headrail)
- Position the shading so that the front (colored fabric) faces you.
- Slide the headrail into the installation brackets so the edge of the headrail is between the lever and the bracket, as shown.
- Firmly push the headrail into each bracket until it clicks and the lever snaps to the right side of the bracket.

IMPORTANT: Carefully pull on the headrail at each bracket to ensure it is installed securely.

- Completely remove the protective covering from the headrail.

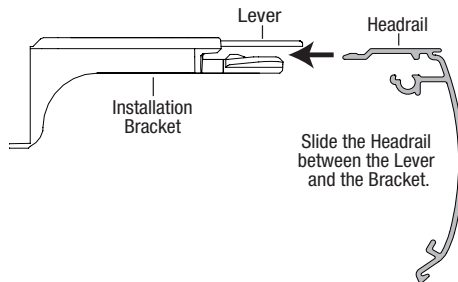

If You Have an Optional Dust Cover (For Outside Mount Shadings)...

The dust cover is used to protect the top of the headrail from exposure to dust on outside mounted shadings.

- Cut the dust cover to desired width.
- Remove the paper backing on one side of the hook and loop fastener dots.
- Apply the dots to the installation brackets on each end of the shading.

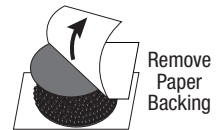

Overhead View — No Dust Cover

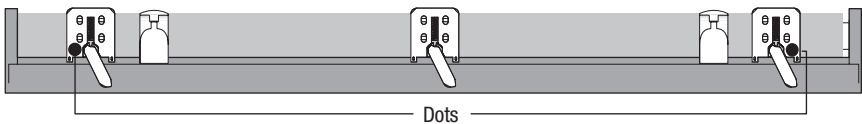

- Remove the remaining paper backing from the dots.
- Center the dust cover over the top of the shading and press it down onto the dots.

Dust Cover Installed



Attach the Magnetic Hold-Down Brackets (Optional)

- Lower the shading, keeping the vanes closed.
- Place the magnetic hold-down bracket onto the bottom rail just inside the end cap, oriented as shown.
- Hold the bracket while opening and closing the vanes. (It may be necessary to have someone assist you.) Adjust the bracket to the best overall position.
- Mark the screw location using the mounting options shown below.
 - ▶ The screw should be placed in the middle of the channel. This will allow for adjustment.

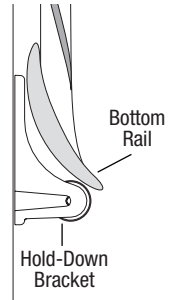

Outside Mount

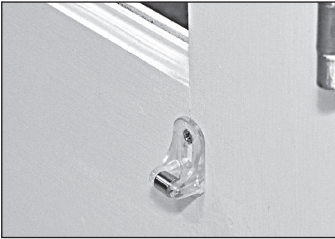

Preferred

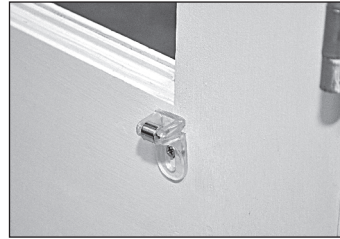

Alternate

Inside Mount



Preferred



Alternate

- Drill the screw holes using a $\frac{3}{32}$ " drill bit.
IMPORTANT: Use drywall anchors when mounting into drywall.
- Attach the hold-down brackets to the mounting surface using the screws provided.
- If necessary, adjust bracket height by loosening the screw and sliding the bracket up or down.

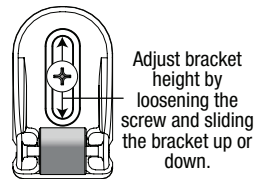

OPERATION

OPERATING THE SHADE

- Tapping the **UP** or **DOWN** button for less than 2 seconds will move the shading in short steps. Holding the **UP** or **DOWN** button down for more than 2 seconds before releasing will operate the shading in the faster standard speed.
- Press the **DOWN** or **UP** button to lower or raise the shading. Press the **STOP/FAVORITE** to stop the shading at the desired position.
- When the shading is fully lowered, tapping the **UP** button will close the vanes.
- To fully raise or lower the shading, simply press the **UP** or **DOWN** button for 2 seconds and then release. The shading will automatically stop when it reaches the upper or lower limit. (If the upper or lower limits are not set at the desired positions, see the Adjust Motor Limits section below)

Note: The factory set lower limit is the shading fully lowered with the vanes in the open position.

Upper and lower limits stops are set at the factory. An intermediate, or "favorite" position is not set at the factory. See Setting Favorites for more information.

Adjust Motor Limits (If Desired) / Setting a Favorites

ADJUST MOTOR LIMITS

The upper and lower limits have been set at the factory. If you need to make adjustments to the limits, follow these instructions.

- Press the **SETTING** button on the back of the wand and hold it in until the motor stops beeping. This will clear both the upper and lower factory limits as well as a favorite if one was set.
- **Set Upper Limit** - Press the **UP** button to get the shading close to the desired upper limit and then press the **STOP** button to stop the shading. Tap the **UP** or **DOWN** button to move the shading to the desired position. To save, press the **SETTING** button until the motor beeps.
- **Set Lower Limit** - Press the **DOWN** button to get the shading close to the desired lower limit and then press the **STOP** button to stop the shading. Tap the **UP** or **DOWN** button to move the shading to the desired position. To save, press the **SETTING** button until the motor beeps.

SETTING & USING A FAVORITE POSITION CHANGING A FAVORITE POSITION

- Use the **UP** or **DOWN** buttons to position the shade at the desired "favorite" position. First press and hold the **SETTING** button on the back of the wand. While holding the **SETTING** button press and hold the **UP** button. Release both buttons when the shade beeps.
- With the shade at either the upper or lower limit, simply press the **STOP/FAVORITE** button to bring the shade to the "favorite" position. To go to the "favorite" position from any other location, make sure the shade has been stopped for at least three seconds before pressing the **STOP/FAVORITE** button.

CHANGING A FAVORITE POSITION

- Use the **UP** or **DOWN** buttons to position the shade at the new desired "favorite" position. First press and hold the **SETTING** button on the back of the wand. While holding the **SETTING** button press and hold the **UP** button. Release both buttons when the shade beeps.
- This establishes a new "favorite" position and erases the old.

CHARGING THE MOTOR BATTERY

When the shade begins to operate slower than normal, or only beeps when you attempt to operate, it is time to charge the battery.

- Plug the 8.4v charger into the port on the wand.
- Plug the charger into an electrical outlet.
- A red light on the charger indicates that the battery is charging.
- To fully charge the batteries, allow the batteries to charge for at least 1 hour after the light on the charger turns green.
- A typical charge cycle can take between 4-6 hours.

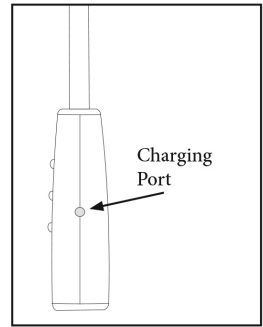

TROUBLESHOOTING

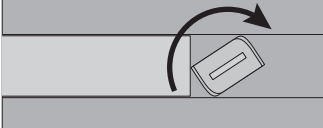
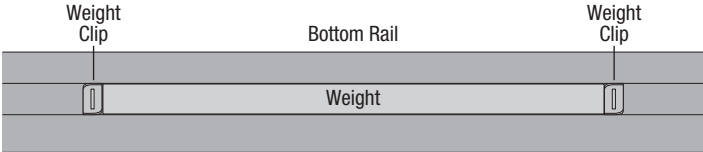
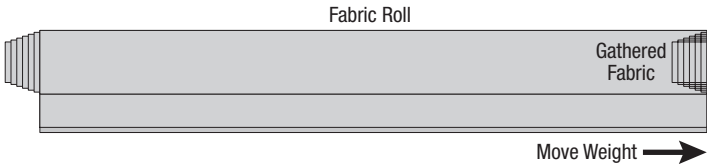
Problem	The shading raises or lowers unevenly, the fabric rubs against one end of the headrail, or the bottom rail is uneven when fully raised.
Solution	<p>Check that the window is square by measuring the diagonals.</p> <p>Check that the installation brackets are level. Shim to level, if necessary.</p> <p>Adjust the bottom rail weight. See below.</p> <p>Adjusting the Bottom Rail Weight</p> <ul style="list-style-type: none"> ■ Release the weight clips by inserting a flat blade screwdriver into the weight clip and turning clockwise. <div style="text-align: right; margin-right: 20px;">  </div> <div style="text-align: center; margin: 10px 0;">  </div> <ul style="list-style-type: none"> ■ Move the weight in 1" increments toward the side where the fabric is gathering. <div style="text-align: center; margin: 10px 0;">  </div> <ul style="list-style-type: none"> ■ Secure the weight clips in position by turning them counterclockwise after making the adjustment. ■ Test and, if necessary, adjust again.

PROBLEM	SOLUTION
The shade raises or lowers unevenly.	<ul style="list-style-type: none"> ■ Check that the installation brackets are level and aligned. Shim the brackets, if necessary.
The motor does not work or runs slowly.	<ul style="list-style-type: none"> ■ Recharge battery.
The shade moves the opposite direction of the control buttons.	<ul style="list-style-type: none"> ■ Press and hold the SETTING button, then press and hold the STOP button. Hold both until the motor jogs (approx. 10 seconds).

CARE

Dusting: Regular light dusting with a feather duster is all the cleaning that is needed in most circumstances.

Vacuuming: Use the soft brush head of the vacuum cleaner on low setting for a more thorough dust removal.

Spot Cleaning:

- Prepare a solution of lukewarm water and mild detergent if needed.
- Dampen a clean cloth or towel in the solution and wring thoroughly.
- Dab the spot with the dampened cloth until spot is removed. Do not rub or soak the fabric.
- Do not spot-clean anything other than the fabric covered headrail on horizontal shadings.
- Allow the shade to dry in completely lowered position.

Spot-cleaning may result in cleaner areas.

Horizontal shadings are made of 100% polyester, which means they are inherently durable and resilient. However, care must be taken to avoid wrinkling the fabric, particularly where the vanes meet the facings.

Fabric Covered Headrail

- Spot-clean the headrail using a sponge or delicate cloth, cool distilled water and a mild soap solution; handle with care as you would any fine fabric.

Forced Air

- Blow away dirt and debris between the vanes using clean compressed air.

Ultrasonic Cleaning

Horizontal shadings can be ultrasonically cleaned by a professional, with the exception of the Light Dimming fabrics.

Light Dimming fabrics.

- Specify that a mild detergent solution be used.
- Never immerse the headrail in the solution.
- Dry the shading completely in the lowered position.

Injection/Extraction

- Horizontal shadings can be professionally cleaned using the injection/extraction method.
- Use only the dry method of injection/extraction Light Dimming fabrics.
- Never immerse the headrail in the solution.

Electrostatic Cleaning

DO NOT use electrostatic cleaning wipes on any horizontal shadings.

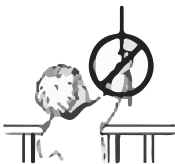

WARNING

For more safety information call 1-888-501-8364
in the U.S. or 1-866-662-0666 in Canada.

WARRANTY INFORMATION

Lifetime Limited Warranty covering our Custom Made Blinds

We extend this lifetime limited warranty to the original purchaser. This warranty applies only to manually operated Custom Products properly installed in the window, door or interior area for which they were intended. Installation of the product must be in accordance with accompanying instructions. The product cannot be modified. It is the purchaser's responsibility to maintain and clean the product in compliance with the instruction provided. The product must be used only in the window for which it was purchased. Damage to the product resulting from misuse, abuse, direct exposure to salty air or discoloration due to sunlight or the passage of time is not covered by this warranty.

This warranty does not apply to conditions caused by normal wear and tear upon the product. This warranty is exclusive and in lieu of all other obligations, liabilities or warranties. In no event shall the Manufacturer be liable for incidental or consequential damages or for any other direct or indirect damage, loss, cost, expense or fee. Some states do not allow the exclusion or limitation of incidental or consequential damages, so this exclusion or limitation may not apply to you.

In the event of a defect under this warranty, we will repair or replace the product, at our option, provided it is returned to our store. Our warranty obligation excludes shipping charges and labor costs for measuring and installation. Repairs will be made with like or similar parts. This warranty gives you specific legal rights, and you may have other rights which vary from state to state.

Notes: Specialty Blinds and Shades are warranted for one year from the date of purchase. Motorization Systems are warranted for five years from the date of purchase.



Window Shadings

Installation, Operation and Care
Instructions



Simplicity Rechargeable

Getting Started:	
Product View	2
Installation:	
Tools and Fasteners Needed	3
Installation Overview	4
STEP 1 – Install the Brackets	4
Mount the Installation Brackets – Inside Mount	5-6
Mount the Installation Brackets – Outside Mount	6-8
Mount the Installation Brackets – End Mount	9
STEP 2 – Install the Shading	10
Attach Magnetic Hold-Down Brackets (Optional)	11
Shade & Remote Setup:	
Link the Remote	12
Set Limits	13
Setting Favorite Position	13
Unlink Remote	14
Link Remote to Multiple Shades	14
Changing Motor Rotation	14
Cloning Additional Remotes	14
Delete Settings from all other Remote	15
Charging the motor battery	15
Solar Panel Mounting Options	15-16
Replacing the Battery in the Remote	16
Troubleshooting	17-18
Care	19
Warranty	20

PRODUCT OVERVIEW

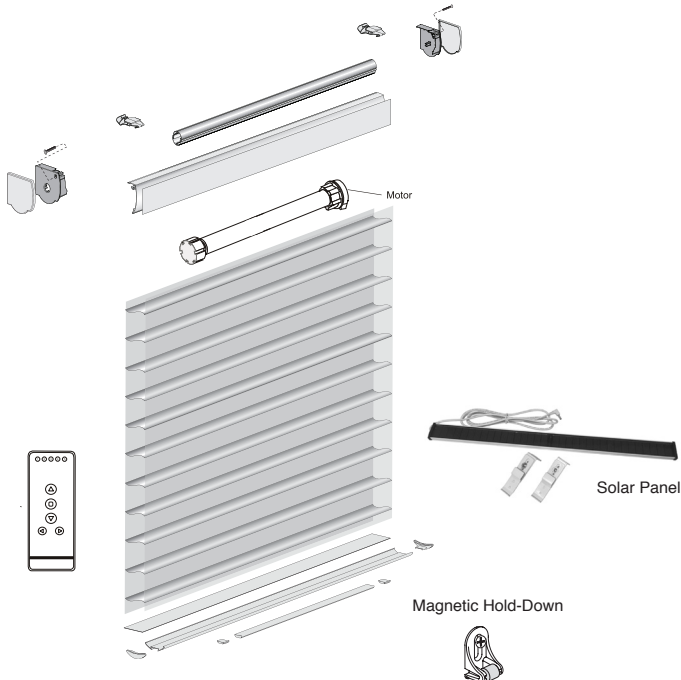

INSTALLATION

Thank you for purchasing Window Shadings. With proper installation, operation, and care, your new shadings will provide years of beauty and performance. Please thoroughly review this instruction booklet before beginning the installation. For information regarding operation and programming, refer to the guide included with your remote control.

Tools and Fasteners Needed

- Flat blade and Phillips screwdrivers
- Level (laser level is recommended)
- Measuring tape and pencil
- Pliers
- Power drill, $\frac{3}{32}$ " drill bit, and $\frac{1}{4}$ " hex driver
- Scissors (heavy-duty)

In addition, you will need fasteners designed to work with your specific mounting surface(s).

- **#6 Hex Head Screws (Provided).** Two $1\frac{1}{2}$ " screws are provided per installation bracket.
- **Longer Hex Head Screws (Not Provided).** If using spacer blocks, use #6 screws long enough for a secure attachment.
- **Speed Nuts and Screws (Provided).** Extension brackets come with screws and speed nuts.
- **Drywall Anchors (Not Provided).** Use drywall anchors when mounting into drywall.



#6 x $1\frac{1}{2}$ "
Hex Head Screw
(Provided)



Longer #6 Hex Head Screw
for Use with Spacer Blocks
(Not Provided)



Speed Nut
and Screw
(Two Provided with
Each Extension Bracket)

Importance of Limit Stops on Window Shadings

Limit stops serve as the upper travel limit for the bottom rail, preventing it from rotating around the fabric roll. Limit stops are located 6" from the ends of the headrail or are centered on shadings less than 36" wide.

When a shading is made, the limit stops are adjusted according to the size of the fabric roll. Occasionally, this adjustment changes during shipping or installation. If this happens, problems can be fixed by readjusting the limit stops. See the Troubleshooting section if shading operation is difficult or if the bottom rail rotates around the fabric roll. Shown below are the four possible positions of limit stops for large to small fabric rolls.

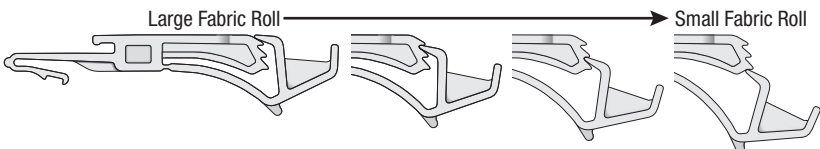

Installation Overview

To install your shading, you will need to perform the following steps:

STEP 1: Install the Brackets

STEP 2: Install the Shading

STEP 1 — Install the Brackets

- Your order will include the correct number of installation brackets for your shading width, as shown in the table below.
- Shading orders may also include spacer blocks or extension brackets, if they were specified for added clearance.
 - Extension brackets are used for end mount shadings, as well.

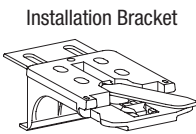

Panel Width	Brackets
14" – 36"	2
36 ¹ / ₈ " – 79"	3
79 ¹ / ₈ " – 96"	4
96 ¹ / ₈ " – 120"	5

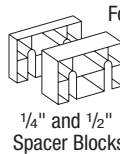

For Added Clearance

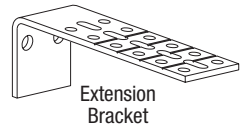

Extension Bracket

Mounting Types and Window Terminology

If the installation brackets are mounted correctly, the rest of the installation process follows easily. To prepare for this important first step, review the mounting types and basic window terminology illustrated below.

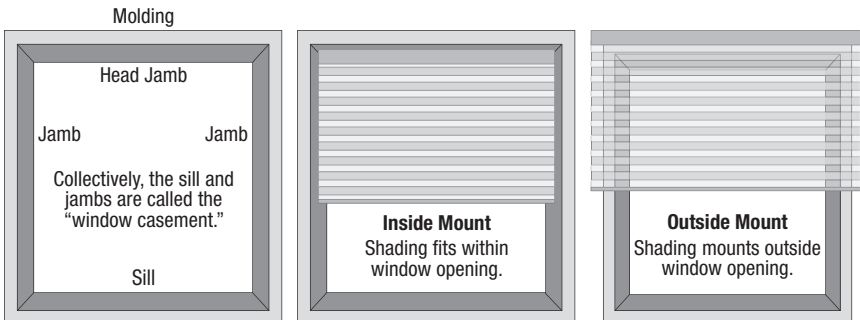

- Refer to the appropriate page below based on your order:

- **Inside Mount — Page 5**
- **Outside Mount — Page 6**
- **End Mount — Page 9**

Mount the Installation Brackets — Inside Mount

Prepare the Installation Brackets

- **If using the optional back cover:** Use pliers or heavy duty scissors to remove both the top and bottom tabs on the installation brackets.
 - Snap the prongs on the back cover brackets into the holes on the back of the installation brackets.

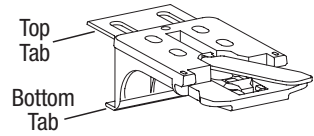

NOTE: Save these tabs once removed. They may be used as shims, if necessary.

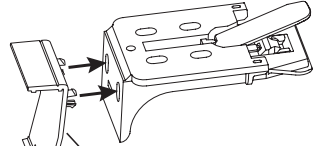

Mount the Installation Brackets

- Measure and mark end bracket locations 2" in from each jamb.
 - If more than two installation brackets are required (see table on page 3), mark the location of additional bracket(s) spaced evenly between the two end bracket locations. Mount into wood whenever possible.

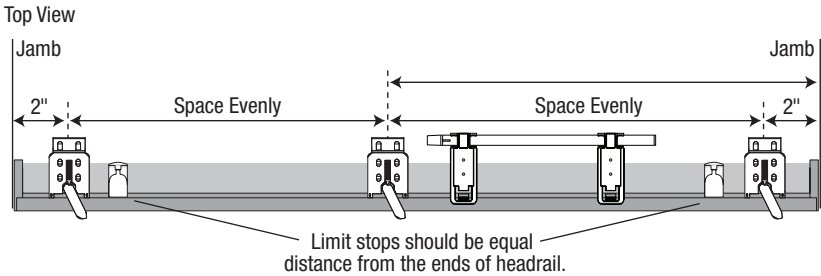

- Center the brackets on your marks, then mark the screw hole locations.
 - Use the rear set of holes with shallow mounting depths. Use the front set of holes when depth permits.

IMPORTANT: The front edges of the installation brackets must be level and aligned.

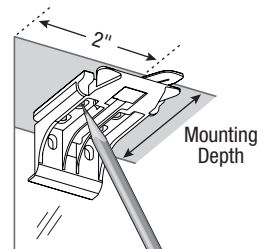

WARNING: Failure to properly align the brackets could result in the headrail releasing from the brackets.

- Drill the screw holes using a $\frac{3}{32}$ " drill bit.

CAUTION: Use drywall anchors when mounting into drywall.

- Use a level to check that the mounting surface is level. Shim the brackets, if necessary. (Use the top tab that was removed from the brackets.)
- Attach the installation brackets using the screws provided.

IMPORTANT: Do not overtighten the screws. Check to ensure the lever can be moved easily side to side. If not, loosen the screws in one-eighth turn increments until the lever can be moved easily.

IMPORTANT: The front edges of the installation brackets must be level and aligned to each other.

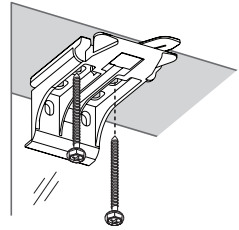

Proceed to “STEP 2 — Install the Shading” on page 10.

Mount the Installation Brackets — Outside Mount

Prepare the Installation Brackets

- Use pliers or heavy duty scissors to remove both the top and bottom tabs on the installation brackets.

NOTE: Save these tabs once removed. They may be used as shims, if necessary.

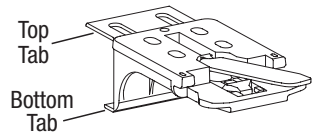

Mount the Installation Brackets

- Center the headrail over the window opening at the desired height. Use a pencil to lightly mark each end of the headrail.
 - Alternatively, measure the width of the headrail and use that width to mark the headrail end points over the window opening.
- Mark 2" in from each of the headrail end marks.
 - If more than two installation brackets came with your order, space additional bracket(s) evenly between the two end brackets and mark their location. Mount into wood whenever possible.

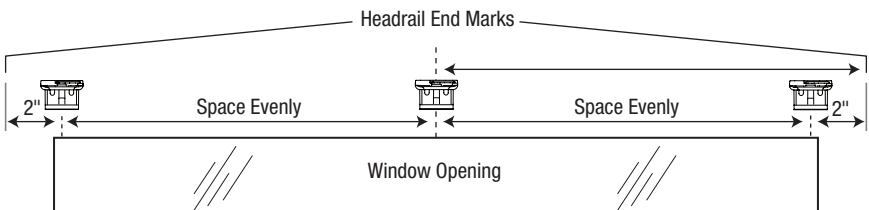

- Center the installation brackets or extension brackets on your marks and mark where to drill the screw holes.
- A minimum 1 1/8" flat vertical surface is required for the installation brackets. Extension brackets require 1 1/4".
- The tops of the installation brackets or extension brackets should be at the desired height. The brackets should be level and aligned.

CAUTION: The rear of the brackets must be flush against a flat mounting surface. Do not mount brackets on curved molding.

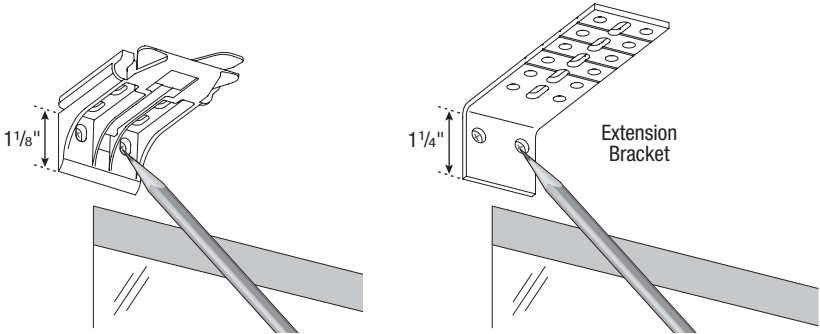

- Drill the screw holes using a 3/32" drill bit.

CAUTION: Use drywall anchors when mounting into drywall.

- Attach the installation or extension brackets using the screws provided.

- The solid side of the spacer blocks faces the mounting surface.

IMPORTANT: The tops of the installation brackets or extension brackets must be level with their front edges aligned.

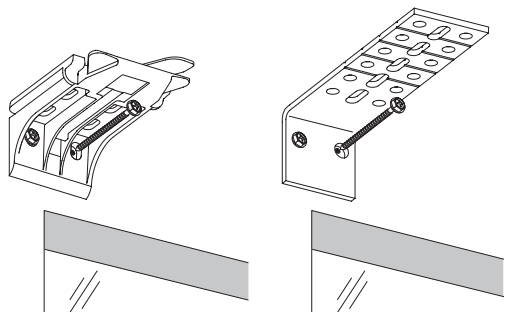
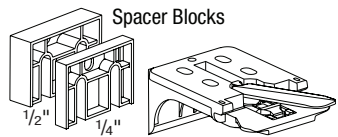

- If using spacer blocks, attach the spacer block(s) and installation bracket to a flat vertical mounting surface with #6 screws long enough for a secure installation.

IMPORTANT: Do not add more than 1 1/2" of clearance using spacer blocks.

IMPORTANT: The tops of the installation brackets must be level with the front edges aligned.

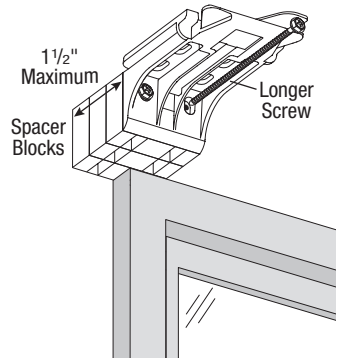

- If using extension brackets, attach an installation bracket to the underside of each extension bracket using the speed nuts and screws provided.

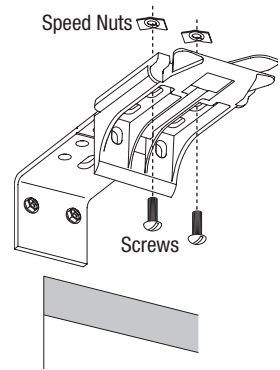

Proceed to "STEP 2 — Install the Shading" on page 10.

Mount the Installation Brackets — End Mount

End mount the headrail when conventional mounting techniques will not work — for example, in an arched window opening.

■ **If using the optional back cover:** Use pliers or heavy duty scissors to remove both the top and bottom tabs on the installation brackets.

- Snap the prongs on the back cover brackets into the holes on the back of the installation brackets.

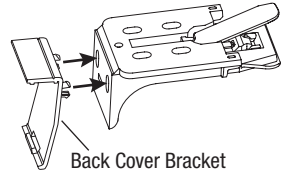
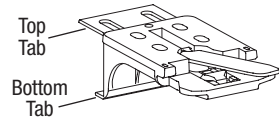

■ Mount the extension brackets on a surface at least 1 1/4" wide.

- Add 1/4" to the minimum depth if using the optional back cover.

■ Attach the installation brackets to the extension brackets using the provided screws and speed nuts.

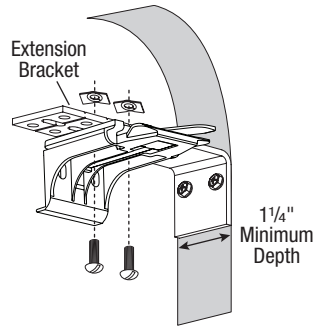

WARNING: To end mount shadings into a surface other than a secure wall stud, use medium to heavy-duty wall anchors (not provided) matched to the wall thickness. Failure to mount the brackets securely may result in injury or property damage.

Proceed to “STEP 2 — Install the Shading” on page 10.

STEP 2 — Install the Shading

- Peel back the protective covering from the top and endcaps of the headrail. (If ordered with fabric covered headrail)
- Position the shading so that the front (colored fabric) faces you.
- Slide the headrail into the installation brackets so the edge of the headrail is between the lever and the bracket, as shown.
- Firmly push the headrail into each bracket until it clicks and the lever snaps to the right side of the bracket.

IMPORTANT: Carefully pull on the headrail at each bracket to ensure it is installed securely.

- Completely remove the protective covering from the headrail.

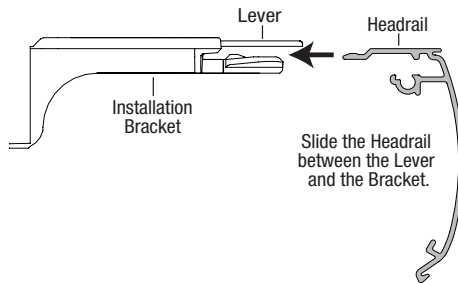

If You Have an Optional Dust Cover (For Outside Mount Shadings)...

The dust cover is used to protect the top of the headrail from exposure to dust on outside mounted shadings.

- Cut the dust cover to desired width.
- Remove the paper backing on one side of the hook and loop fastener dots.
- Apply the dots to the installation brackets on each end of the shading.

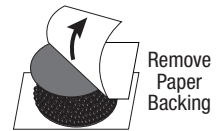

Overhead View — No Dust Cover

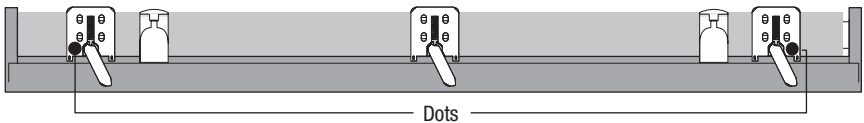

- Remove the remaining paper backing from the dots.
- Center the dust cover over the top of the shading and press it down onto the dots.

Dust Cover Installed



Attach the Magnetic Hold-Down Brackets (Optional)

- Lower the shading, keeping the vanes closed.
- Place the magnetic hold-down bracket onto the bottom rail just inside the end cap, oriented as shown.
- Hold the bracket while opening and closing the vanes. (It may be necessary to have someone assist you.) Adjust the bracket to the best overall position.
- Mark the screw location using the mounting options shown below.
 - ▶ The screw should be placed in the middle of the channel. This will allow for adjustment.

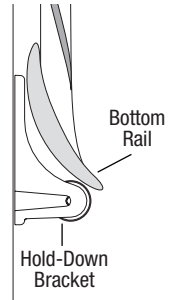

Outside Mount

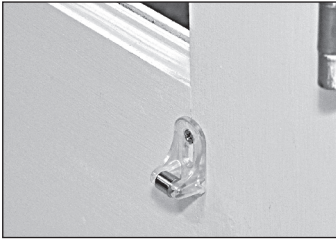

Preferred

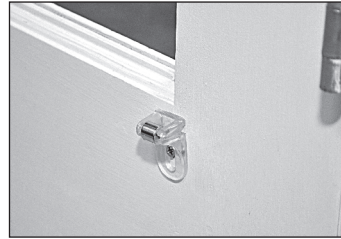

Alternate

Inside Mount



Preferred



Alternate

- Drill the screw holes using a $\frac{3}{32}$ " drill bit.
IMPORTANT: Use drywall anchors when mounting into drywall.
- Attach the hold-down brackets to the mounting surface using the screws provided.
- If necessary, adjust bracket height by loosening the screw and sliding the bracket up or down.

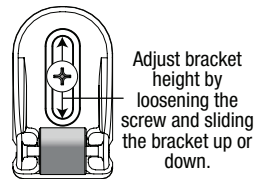

SHADE & REMOTE SETUP

Make sure shades are mounted securely before operating.

REMOTE CONTROL

For added protection, remote controls arrive:

- With a protective film, please remove this film prior to use.
- **All shades are shipped un-linked to Remote.** Install all shades prior to linking to the remote.



Upper and lower limits are set at the factory. Please follow sections below to link the shade to the remote and set the limits (if needed) along with favorite position if desired.

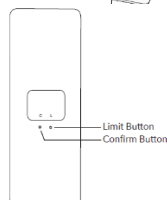
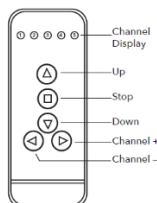

Step 1: Link Remote Control to the Shade

(One shade at a time)

Before linking the remote, determine which shade(s) you want on which channel. Remote has 5 channels. Select the desired channel with the **CHANNEL + or -** buttons. The channel indicator light will illuminate the channel that is on.

Single Shade:

1	Press SETTING button on the motor until the shade jogs.	Release the button when shade jogs.
2	Press and hold the CONFIRM (C) button until the shade jogs.	Shade jogs, shade is linked to that remote and channel.

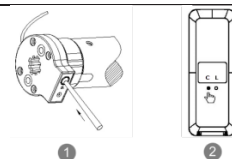

If all 5 lights are lit, the remote will control all 5 channels at once. All shades linked to the remote will also automatically be programmed to the "ALL" channel.

Press and hold the **UP** or **DOWN** buttons for 2 or more seconds to raise or lower the shade. Shade will move to full limits after button has been pressed for more than 2 seconds.

Press the **STOP** button to stop the shade anywhere along the window.

Tapping the **UP** or **DOWN** buttons for less than 2 seconds will move the shade in short steps. Holding the **UP** or **DOWN** buttons for more than 2 seconds before releasing will operate the shade to programmed limits.

- If limits are set correctly, skip step 2 and continue to **Step 3: Setting Favorite Position** if desire to set a favorite position.
- If limits need to be reset, please follow instructions under **Step 2: Set Limits**.

Step 2: Set Limits (Lower & Upper Limit must be set at the same time, cannot be set independently) **Lower limit must be set before Upper limit			
Lower Limit:			
1	Press and hold LIMIT (L) button on remote	Release this button when shade jogs.	
2	Press DOWN button	Lower the shade	
3	Press STOP when the shade is near the desired lower limit.	Shade stops	
4	Press either UP or DOWN button to adjust to final limit.	Shade moves step by step to precisely adjust lower limit.	
5	Press CONFIRM (C) on remote.	Shade jogs, this sets the lower limit.	
Upper Limit:			
6	Press UP button	Shade goes up	
7	Press STOP when the shade is near the desired upper limit.	Shade stops	
8	Press either UP or DOWN button to adjust to final limit.	Shade moves step by step to precisely adjust upper limit.	
9	Press CONFIRM (C) button until shade jogs.	Setting is completed when shade jogs.	

****Test the shade,** making sure shade stops at both lower and upper limits. If shade does not stop at desired location, repeat instructions under **Step 2: Set Limits**.

Step 3: Setting Favorite Position			
1	Use the UP or DOWN buttons to position the shade.	Stop at the desired "Favorite" position.	
2	Press and hold LIMIT (L) button, then also press UP button	Release both buttons when the shade jogs.	
When the shade is at either the upper or lower limit, simply press the STOP button to bring the shade to the "favorite" position, make sure the shade has been stopped for at least three seconds before pressing the STOP button.			

- ❖ If no other shades to link, programming is complete.
- ❖ If there are more shades to link but on "different channel" follow all of the steps above.
- ❖ If have more shades to link to the "same channel" please **UNLINK (Step 4)** the programmed shades also on that channel. **Follow all prior instructions for the remaining shades. All programmed shades on the same channel need to be unlinked first before linking a new shade and setting its' limits.**

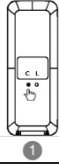

Step 4: Unlink Remote from the Shade			
1	Select channel motor is on. Press and release CONFIRM (C) button on remote 3 times.	Shade jogs, shade is unlinked	

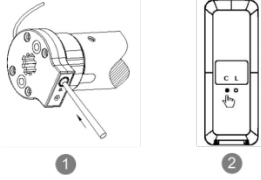
- ❖ After settings on all shades are completed for the same channel, select the desired channel and follow instructions under **Step 5: Link Remote Control to the Multiple Shades**. All Limits previously set for each shade will be restored.

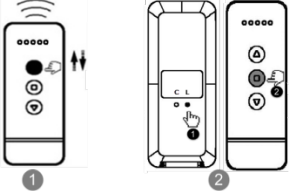
Step 5: Link Remote Control to Multiple Shade			
Before linking the remote, determine which shade(s) you want on which channel. Select the desired channel with the CHANNEL + or - buttons. The channel indicator light will illuminate the channel that is on.			
Multiple Shades:			
1	Press SETTING button on the motor until the shade jogs.	Release the button when shade jogs.	
	Repeat above step for all shades that will be controlled by the same channel.		
2	Press and hold the CONFIRM (C) button until all the shades jog.	Shades jog, program have been done.	
Remote has 5 channels. If all 5 lights are lit, the remote will control all 5 channels at once. All shades linked to the remote will also automatically be programmed to the "ALL" channel.			

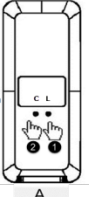
Change Motor Rotation (Direction) (Only needed when shade is operating in opposite direction)			
1	Press UP button	If shade goes up, do nothing. If shade goes down, please continue with following steps.	
2	Press and hold LIMIT button, then press STOP button	Release both buttons when shade jogs.	
3	Press UP button	Shade goes up, rotation direction has been corrected.	

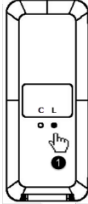
Cloning additional remote			
	Remote A (motors are programmed to this remote) Press and hold LIMIT (L) button then also press CONFIRM (C) button	Release both buttons once shade jogs	
2	Remote B : Press CONFIRM (C)	Shade jogs again, remote B has programmed with the shade.	

Delete settings from all other remotes				
1	Remote A : Press LIMIT (L) button, then press DOWN button	Release both buttons once shade jogs. All setting in other remotes are deleted except remote A.		

CHARGING THE MOTOR BATTERY

When the shade begins to operate slower than normal or only beeps when you attempt to operate, it is time to charge the battery.

Charge with a Charger:

- Plug the 8.4v charger into the charging port on the motor.
- Plug the charger into an electrical outlet.
- A red light on the charger indicates that the battery is charging.
- To fully charge the batteries, allow the batteries to charge for at least 1 hour after the light on the charger turns green.
- A typical charge cycle can take between 4-6 hours.

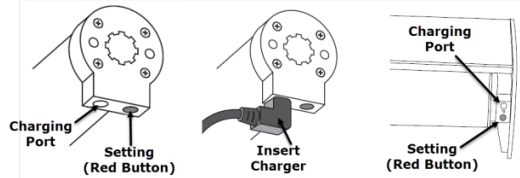

Charging time:

The motor takes approximately 4 hours to be charged when power is low. We recommend leaving the charger in for an extra hour after the indicator turn green. To protect the rechargeable batteries inside the motor, **charger must be unplugged when fully charged.**

Charge with Solar Recharge Unit:

Determine solar recharge unit placement. The solar recharge unit should be placed at the location where gets the maximum amount of sunlight per day. **In most cases this can be achieved by mounting the unit directly to the glass with double sided tape.**

Brackets are provided if attaching to the glass is not possible. The brackets may be mounted several different ways depending on the application (window depth, window width, etc.). Check depth clearance behind the shade before mounting.

The unit requires 19" minimum window width to mount horizontally.

Mounting Options:

Tape Method – Cut the tape to fit inside the white border as shown. Clean the ends of the solar panel where the tape will go with rubbing alcohol. When dry, remove the release liner from one side of the double sided tape and adhere them to face of the panel. Make sure to put the tape on the face (black side) of the panel.

- Clean the window surface with rubbing alcohol. When dry, remove the release liners and attach the solar panel to the glass, pressing firmly to adhere.
- Connect solar recharge unit to motor charging port

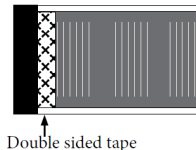

Bracket Method – If using brackets, set the bottom groove of the unit onto the bottom bracket hook. Then press the top of the unit until it snaps into place. If space is limited it may be easier to attach the brackets to the solar unit before screwing the brackets in place.

- **Inside Mount Bracket** can be mounted behind or next to shade mounting bracket.
- **Inside Mount Extended.** Bottom portion of the bracket may be lowered if needed for more sun exposure.
- Bracket can be mounted behind or next to shade mounting bracket.
Note: only two of the holes are threaded.
- **Inside Mount with Top Reversed.** The top portion of the bracket may be reversed if necessary depending on space. Bracket can be mounted behind or next to shade mounting bracket.
- **Outside Mount.** This method will provide the least amount of sun exposure. Bracket can be mounted next to shade mounting bracket.

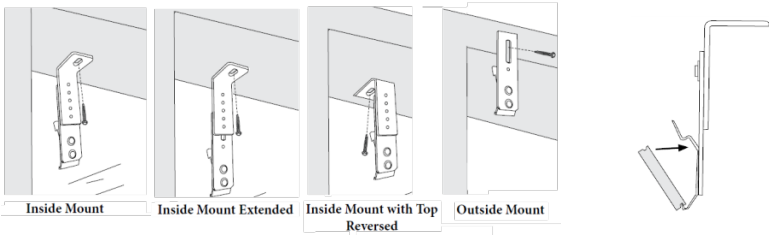

- Install Solar Recharge Unit – If space is limited it may be easier to attach the brackets to the solar unit before screwing the brackets in place.
- Connect solar recharge unit to motor charging port

REPLACING THE BATTERY IN THE REMOTE

Remove the battery tray from the remote by inserting a fingernail into the indentation on the back of the remote. To avoid the battery falling out of the remote, remove the tray while the remote is face up.

Insert the new battery (CR2430 lithium) into the battery tray so that the writing is facing up when the remote is face up. Slide the tray back into the remote.



TROUBLESHOOTING

PROBLEM	SOLUTION
The shade does not work or runs slowly.	Recharge the motor.
The shade only goes in one direction.	The limit setting was unsuccessful and needs to be reset.
The shade raises or lowers unevenly.	Check that the installation brackets are level and aligned. Shim the brackets, if necessary.
Shade goes up when the down button is pushed and goes down when the up button is pushed.	Press the Limit button on the underside of the remote and Stop button at the same time. Hold until the shade jogs once. The shade should now move in the correct direction.
The indicator light on the remote does not light up or the remote-controlling range becomes shorter.	Replace the battery in the remote (CR2430 Lithium)
Indicator light on the remote is flashing.	Check on confirm or limit button behind the remote, make sure it's not stuck under the remote housing.

TROUBLESHOOTING

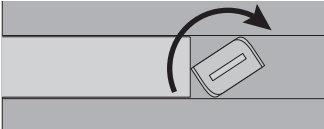
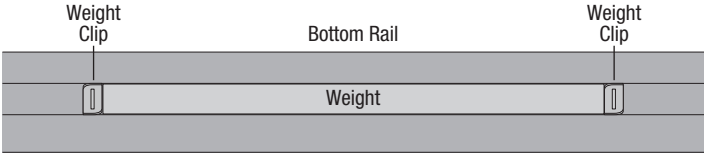
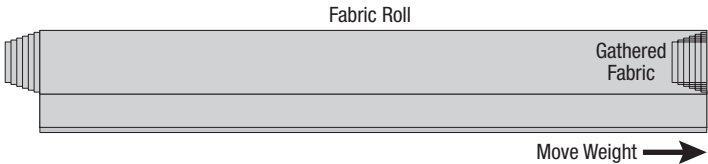
Problem	The shading raises or lowers unevenly, the fabric rubs against one end of the headrail, or the bottom rail is uneven when fully raised.
Solution	<p>Check that the window is square by measuring the diagonals.</p> <p>Check that the installation brackets are level. Shim to level, if necessary.</p> <p>Adjust the bottom rail weight. See below.</p> <p>Adjusting the Bottom Rail Weight</p> <ul style="list-style-type: none">■ Release the weight clips by inserting a flat blade screwdriver into the weight clip and turning clockwise.  <p>Weight Clip Bottom Rail Weight Clip</p>  <p>Weight</p> <ul style="list-style-type: none">■ Move the weight in 1" increments toward the side where the fabric is gathering.  <p>Fabric Roll Gathered Fabric</p> <p>Move Weight →</p> <ul style="list-style-type: none">■ Secure the weight clips in position by turning them counterclockwise after making the adjustment.■ Test and, if necessary, adjust again.

CARE

Dusting: Regular light dusting with a feather duster is all the cleaning that is needed in most circumstances.

Vacuuming: Use the soft brush head of the vacuum cleaner on low setting for a more thorough dust removal.

Spot Cleaning:

- Prepare a solution of lukewarm water and mild detergent if needed.
- Dampen a clean cloth or towel in the solution and wring thoroughly.
- Dab the spot with the dampened cloth until spot is removed. Do not rub or soak the fabric.
- Do not spot-clean anything other than the fabric covered headrail on horizontal shadings.
- Allow the shade to dry in completely lowered position.

Spot-cleaning may result in cleaner areas.

Horizontal shadings are made of 100% polyester, which means they are inherently durable and resilient. However, care must be taken to avoid wrinkling the fabric, particularly where the vanes meet the facings.

Fabric Covered Headrail

- Spot-clean the headrail using a sponge or delicate cloth, cool distilled water and a mild soap solution; handle with care as you would any fine fabric.

Forced Air

- Blow away dirt and debris between the vanes using clean compressed air.

Ultrasonic Cleaning

Horizontal shadings can be ultrasonically cleaned by a professional, with the exception of the of the Light Dimming fabrics.

Light Dimming fabrics.

- Specify that a mild detergent solution be used.
- Never immerse the headrail in the solution.
- Dry the shading completely in the lowered position.

Injection/Extraction

- Horizontal shadings can be professionally cleaned using the injection/extraction method.
- Use only the dry method of injection/extraction Light Dimming fabrics.
- Never immerse the headrail in the solution.

Electrostatic Cleaning

DO NOT use electrostatic cleaning wipes on any horizontal shadings.



WARNING

For more safety information call 1-888-501-8364
in the U.S. or 1-866-662-0666 in Canada.

WARRANTY INFORMATION

Lifetime Limited Warranty covering our Custom Made Blinds

We extend this lifetime limited warranty to the original purchaser. This warranty applies only to manually operated Custom Products properly installed in the window, door or interior area for which they were intended. Installation of the product must be in accordance with accompanying instructions. The product cannot be modified. It is the purchaser's responsibility to maintain and clean the product in compliance with the instruction provided. The product must be used only in the window for which it was purchased. Damage to the product resulting from misuse, abuse, direct exposure to salty air or discoloration due to sunlight or the passage of time is not covered by this warranty.

This warranty does not apply to conditions caused by normal wear and tear upon the product. This warranty is exclusive and in lieu of all other obligations, liabilities or warranties. In no event shall the Manufacturer be liable for incidental or consequential damages or for any other direct or indirect damage, loss, cost, expense or fee. Some states do not allow the exclusion or limitation of incidental or consequential damages, so this exclusion or limitation may not apply to you.

In the event of a defect under this warranty, we will repair or replace the product, at our option, provided it is returned to our store. Our warranty obligation excludes shipping charges and labor costs for measuring and installation. Repairs will be made with like or similar parts. This warranty gives you specific legal rights, and you may have other rights which vary from state to state.

Notes: Specialty Blinds and Shades are warranted for one year from the date of purchase. Motorization Systems are warranted for five years from the date of purchase.

