

Radio Technology Motor & Controls for Custom Roman Shades



INSTALLATION INSTRUCTIONS

INSTALL THE SHADE BEFORE ATTEMPTING TO OPERATE THE MOTOR.

Installation Kit Includes:

| Part | Quantity |
|--|--|
| a. Mounting Brackets (Outside Mount Only!) | 2 (shades up to 36" wide) 3 (shades 36" to 48" wide) 4 (shades 48" to 96" wide) 5 (shades 96" to 120" wide) |
| b. 1/4" Screws | 2 (shades up to 36" wide) 3 (shades 36" to 48" wide) 4 (shades 48" to 96" wide) 5 (shades 96" to 120" wide) |
| c. 3/4" Screws for Outside Mount | 2 (shades up to 36" wide) 3 (shades 36" to 48" wide) 4 (shades 48" to 96" wide) 5 (shades 96" to 120" wide) |
| d. Radio Frequency Remote | 1 |
| e. Wall Holder for Remote | 1 |

Wallboard or Plaster: use anchors specifically designed for hollow walls (not included).

Concrete, Stone, Brick: use a masonry drill bit and anchors or screws specifically designed for masonry (not included).

Tools Required:

Tape measure, pencil, drill, drill bits, level, step stool or ladder.

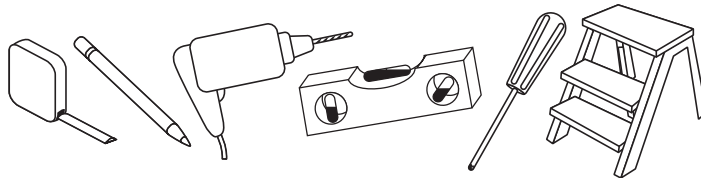

Note: use a 5/64" drill bit to pre-drill the screw holes (for attachment to a wall stud or header board). Use Wall Anchors (not included) for hollow dry wall or plaster mounting.

Installation:

For Outside Mounting

One bracket should be positioned about 2" to 6" from each end of the head rail. For wider shades that require 3 or more brackets, these should be spaced evenly between the two outermost brackets. Hold the shade in place and mark the desired bracket locations with a pencil.

The brackets must be level – use a Spirit Level if necessary to assure proper alignment.

The brackets will be attached to the bottom of the head rail, so attach the brackets to the wall or window frame first. Pre-drill the mounting holes using a 5/64" drill bit, and then screw the brackets in place.

Place the head rail against the brackets as illustrated – center the shade over the window opening – then mark the location of each mounting hole on the head rail. Pierce the fabric at the hole locations using the tip of a screw, then pre-drill the mounting holes using a 5/64" drill bit. Attach the shade to the brackets using the 3/4" screws provided.

For Inside Mounting:

Mounting holes are pre-drilled in the Head Rail. Screw the 1 1/4" screws into the head rail until the tips of the screws extend very slightly beyond the top of the head rail. Align the front of the shade with the front edge of the window opening (or position as desired), making sure that the shade is centered in the window opening – then push up

on the screws so that the screw heads leave tiny impressions in the top of the window frame. Now, use the impressions as a guide and pre-drill the mounting holes using a 5/64" drill bit – then screw the shade in place.

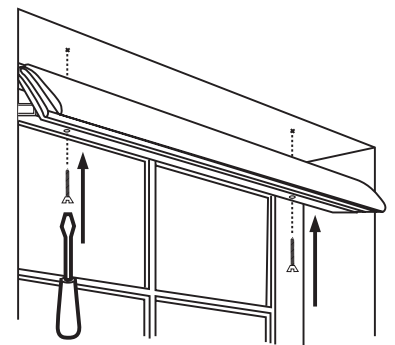
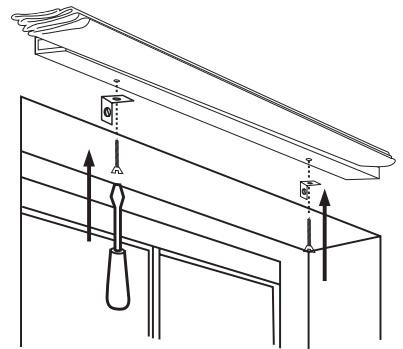

Remote Transmitters

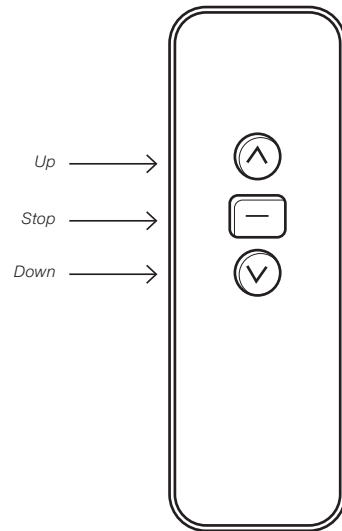

**Single Channel
Remote Control Transmitter**

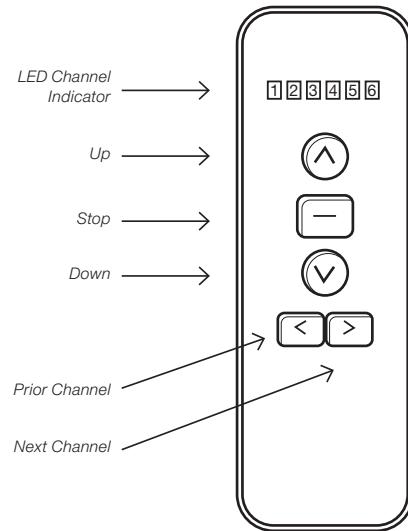

**Six (6) Channel
Remote Control Transmitter**

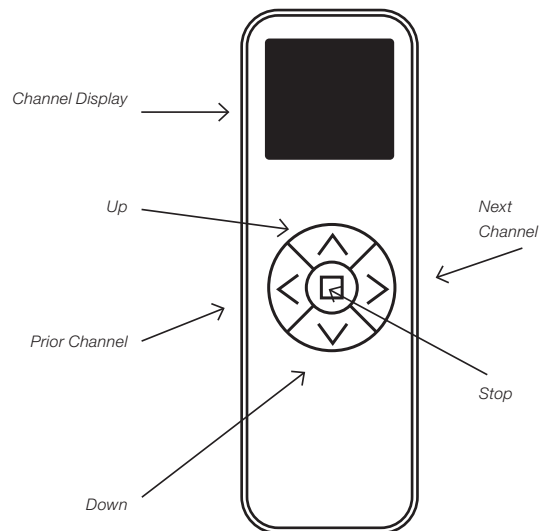

**Sixteen (16) Channel
Remote Control Transmitter**

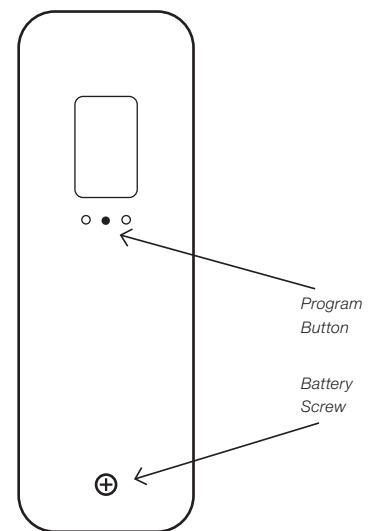

**Back of Remote Control
Transmitter**

Motor Head

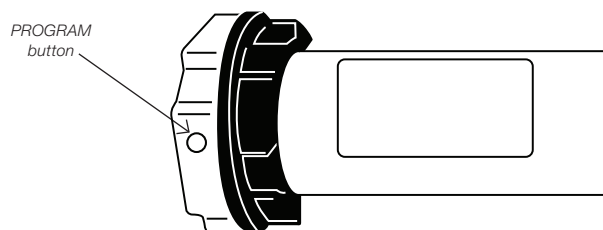

Radio Technology Motor & Controls for Custom Roman Shades

PROGRAMMING AND OPERATION OF RADIO TECHNOLOGY MOTORS

IMPORTANT: The Upper & Lower limit positions (full UP & DOWN positions) have been pre-set at the factory – also, a Channel Number has been assigned to each shade - therefore, it is not necessary to perform Steps 1, 2 & 3 below – however, we recommend that you read these to familiarize yourself with the basics of programming the motor and remote control and to fully understand the function of your motorized shade. Also, note that the batteries in the motor are fully charged at the factory prior to shipment.

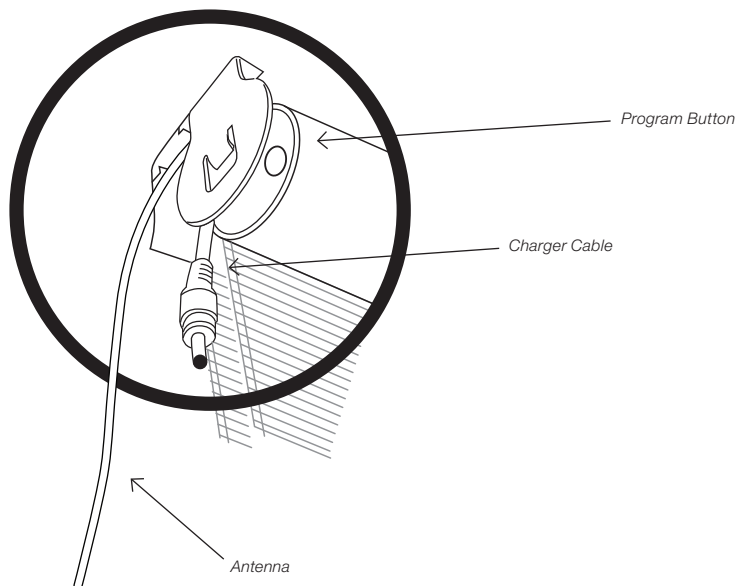

1. Channel Selection for Each Shade

When you receive your shades the channel number pre-assigned to each shade will be marked on the shade and/or carton. Per the notice above, it is not necessary to perform Steps 1, 2 & 3 as these settings are done at the factory and will require no adjustment under normal circumstances.

A channel number must be assigned to each motor/shade. The assigned numbers should be sequential starting with #1 (1, 2, 3 etc.).

Press the channel buttons/arrows to select a dedicated channel for each shade prior to mating each shade/motor to the remote controller.

2. Programming/Mating

REMINDER: the motor and remote have been pre-set at the factory – programming information for Steps 1, 2 & 3 is provided as background information only.

Identify the head of the motor housing on the left side of the shade (see drawing) - Press the PROGRAM button until the motor beeps and the shade oscillates (the shade will oscillate - a quick back and forth movement of the shade) Press the UP button on the remote (see drawing) – the shade will oscillate again – the motor and transmitter are now mated.

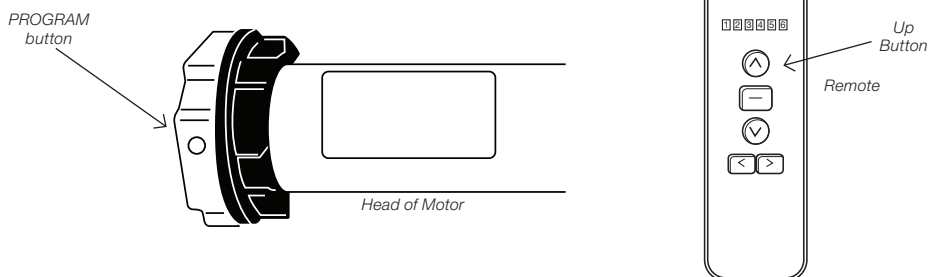

3. Setting UP and DOWN Limit Positions

NOTE: Upper and lower limit positions have been pre-set at the factory - programming information for Steps 1, 2 & 3 is provided as background information only.

Set the UP position:

Move the shade 6" to 10" below the desired upper limit by pressing the UP or DOWN arrows/buttons on the remote. Press the PROGRAM button on the back of the remote – the motor will oscillate – this puts the motor in program mode. Now move the shade up to the desired UP position and press the program button again – the motor will oscillate and the upper limit is now set.

Set the DOWN position:

Move the shade down from the upper limit position to a point 6" to 10" from the bottom, and then press the PROGRAM button on the back of the remote – the motor will oscillate and is once again in program mode. Now move the shade to the desired DOWN position and press the PROGRAM button the motor will oscillate and the lower limit is now set.

NOTE: after all limits are set, see the remote control operating instructions below.

4. Setting Intermediate Positions & Other Settings

Setting INTERMEDIATE positions

Up to (4) intermediate positions can be set.

Move the shade at least 6 inches away from the previously set limits – press the PROGRAM button on the rear of the remote – the motor will oscillate and is now in program mode.

Now move the shade to any desired intermediate STOP position and press the PROGRAM button again – the motor will oscillate and the intermediate STOP position is now set.

Repeat this process to set additional intermediate STOP positions.

When setting a limit, if there is no action within 30 seconds, the motor will automatically exit the limit programming mode.

Limit Position Fine Tuning: move the shade to the limit position that you wish to adjust. Press the program button on the rear of the remote – the motor will oscillate and is now in limit setting mode. Use the UP/DOWN buttons on the remote to establish a new position – press the program button on the rear of the remote – the motor will oscillate and the fine-tune setting is now complete.

Erasing Limits:

Note: the 1st/Upper limit cannot be erased – it can only be eliminated by deleting all memory

Move the shade to the limit position that you wish to erase – press and hold the PROGRAM button on the rear of the remote for approximately 7 seconds – the motor will oscillate twice, and the limit has been erased.

Deleting Memory

To Delete All Memory: Press the program button on the head of the motor 4 times (@ one second intervals), and then press a fifth time and hold the button down (approximately 7 seconds) until the motor oscillates twice. All memory is now erased.

Deleting Memory for a Single Channel: Set the remote transmitter on the channel to be deleted. Press the STOP button for approximately 5 seconds – the motor will oscillate. Now press the program button on the rear of the remote – the motor will oscillate and the single channel is deleted

Using the Remote Control Transmitter

Press the UP/DOWN button once and the shade will move to the next pre-set limit position.

Press the UP/DOWN button twice at the speed of once per second and the shade will move to the UP or DOWN limit position without stopping at any intermediate position.

When the up position has been reached, the UP button becomes non-functional, and when the down position has been reached the DOWN button becomes non-functional.

Controlling Multiple Shades Simultaneously

6 Channel Remote: press the channel selector until all six lights are lit to control up to 6 shades at the same time using the remote control as described above.

16 Channel Remote: press the channel selector button until "CC" appears in the display window to control up to 16 shades at the same time using the remote control as described above.

Operating the Shade

To raise and lower the shade, use the remote control as described above.

Charging the Batteries

Connect the AC Charger to the Charger Cable attached to the motor head – charge for 8 hours.

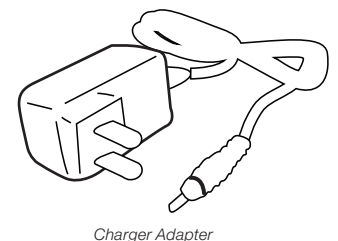
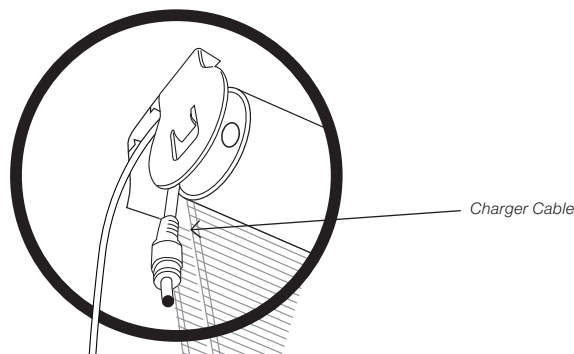

Radio Technology Motor & Controls for Custom Roman Shades

Installation/Replacement of the Remote Control Battery

Remove the cover on the rear of the remote by removing the screw and sliding the back plate upward slightly – install a 3V [CR2032] disk type battery as illustrated.

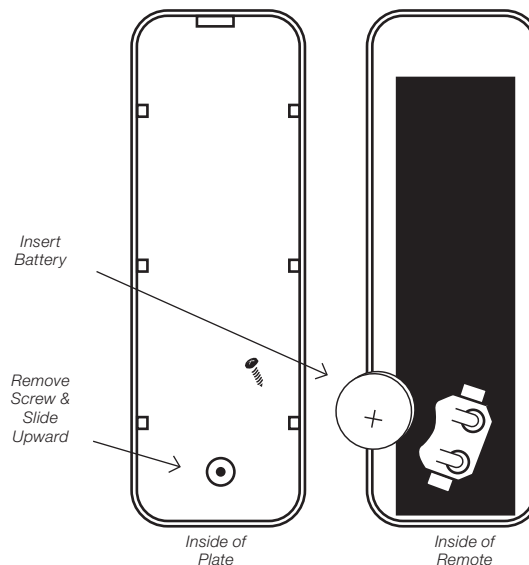

Installation of Optional Wall Mount Holder

Attach the remote holder using the screws provided (use wall anchors for hollow dry wall), or peel the foil off the adhesive pad on the back of the remote holder and press it into place on any clean flat surface.

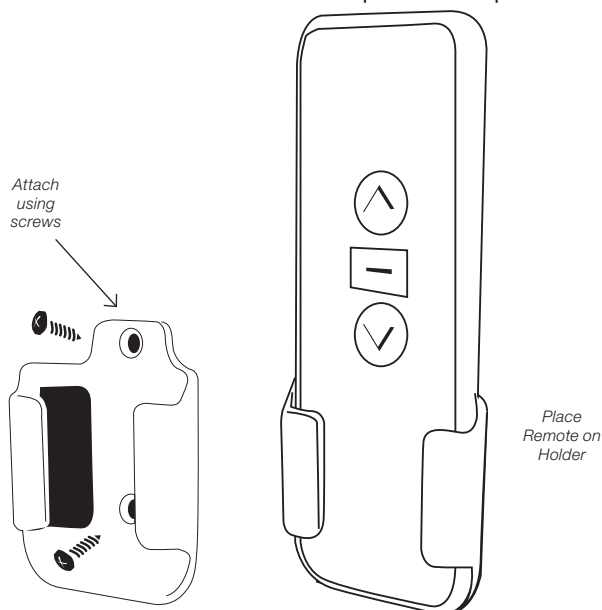

CUSTOMER SERVICE: 1-800-264-1190

General Safety Instructions for Motorized Shades

- Do not expose the motor or transmitter to moisture or extreme temperatures
- Do not allow children to play with this device
- Use or modification outside the scope of this instruction manual will void the warranty
- If cable or power connector is damaged, do not use
- Keep the antenna straight and clear from metal objects

Statement Regarding FCC Compliance

This device complies with Part 15 of the FCC rules. Operation is subject to the following two conditions:

- 1) This device may not cause interference, and
- 2) This device must accept any interference received, including interference that may cause undesired operation.

Note:

This equipment has been tested and found to comply with 15 of the FCC Rules. These limits are designed to provide reasonable protection against harmful interference in a residential installation. This equipment generates, uses and can radiate radio frequency energy and, if not installed and used in accordance with the instructions, may cause harmful interference to radio communications.

However, there is no guarantee that interference will not occur in a particular installation. If this equipment does cause harmful interference to radio or television reception, which can be determined by turning the equipment off and on, the user is encouraged to try to correct the interference by one or more of the following measures:

- Reorient or relocate the receiving antenna.
- Increase the separation between the equipment and the receiver.
- Connect the equipment into an outlet on a circuit different from that to which the receiver is connected.
- Consult the dealer or an experienced radio/TV technician for help.

Any changes or modifications not expressly approved by the party responsible for compliance could void the users authority to operate the equipment.

Cleaning

To clean the shade fabric, use a feather duster or vacuum lightly using the soft brush or upholstery attachment. For spot cleaning, use warm (not hot!) water with a mild soap to damp clean.

REPLACEMENT PARTS

In the event that replacement parts are ever needed, you may call: 1-800-264-1190

Please be sure to provide the following information, if possible:

- The complete model or catalog number of your product
- A description of the product
- A description of the part needed

WARNING



- Always keep cords out of children's reach.
- Move furniture away from cords and bead chains. Children can climb furniture to get to cords.

THIS PRODUCT HAS BEEN ENGINEERED AND MANUFACTURED TO MEET THE SAFETY STANDARDS ESTABLISHED BY THE WINDOW COVERING SAFETY COUNCIL.

IMPORTANT INFORMATION ABOUT YOUR ROMAN SHADE

This product is designed to make your shade safer for children and pets. However, this shade is substantially different than the traditional shades that you might be accustomed to.

The cording system on the back of the shade is designed to help minimize the possibility of a child or pet becoming entangled in the cords.

LIMITED LIFETIME WARRANTY

The enclosed product is warranted to the original residential retail purchaser as long as the product remains in the original window.

Covered

Lifetime: Entire product against manufacturing defects (i.e. a flaw in the product design, materials, or workmanship that causes the product to no longer function).

3 Years: Cords, including internal cords such as those found in cordless blinds or shades.

5 Years: All fabric

3 Years: Battery Operated Motors

Radio Technology Motor & Controls for Custom Roman Shades

Not Covered

1. Normal wear and Tear

2. Any product that fails due to:

- Abuse
- Alterations
- Exposure to salt air
- Improper cleaning
- Improper installation
- Misapplication
- Accident
- Damage from pests/insects/pets
- Extraordinary use
- Improper handling
- Improper operation
- Misuse

3. Natural Wood Products that have:

- Loss of color intensity
- Variations in color, grain or texture
- Warping of wood slats in high humidity areas

4. Costs associated with:

- Product removal
- Transportation to and from the retailer
- Brand label removal
- Product re-measure
- Product reinstallation
- Shipping
- Incidental or consequential damages

In the event there are multiple blinds/shades in the same room, only the defective blind/shade will be replaced

To Report Shipping Damage:

If damage occurred during shipping, call the place of purchase and report within 7 calendar days, or you may be denied credit for your damaged product.

To Obtain Service:

If you suspect this product has a manufacturing defect in materials or workmanship:

- Locate the sales receipt
- Call place of purchase

Any unauthorized returns will not be accepted.

Warranty Remedy:

This shall be your sole remedy under this limited warranty.

If this product is found to have a manufacturing defect in materials or workmanship, we will, at our discretion, do one of the following:

- Repair the product
- Replace the product
- Refund the cost of the product

Colors may vary from lot to lot and may not exactly match sample swatches or previous purchases.

Discontinued items or color selections will be replaced with the closest equivalent current product.

Your rights under state law: This lifetime limited warranty gives you specific legal rights, and you may have other rights which vary from state to state. Some states do not allow limitations on how long a warranty lasts, so the above limitations may not apply to you. No agent, representative, dealer

or unauthorized employee has the authority to increase or alter the obligation of this warranty. This lifetime limited warranty supersedes any previous versions