

## INSTALLATION INSTRUCTIONS

### HONEYCOMB Shades



#### Motorization

Thank you for your purchase. This shade has been custom built for you from the highest quality materials. To avoid errors and save valuable time, please read these instructions before installing your new shades.

### TOOLS YOU WILL NEED

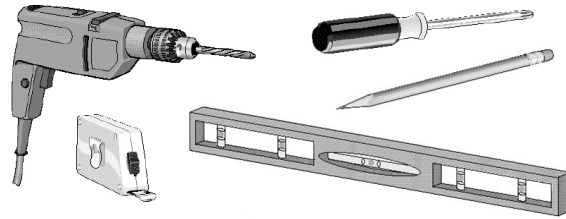
1. Pencil or Marker
2. Measuring Tape
3. Phillips Screwdriver
4. Carpenter's Level
5. Power Drill
6. Mounting Fasteners



Mounting Surface	Fastener
Drywall, Plaster	Wall Anchors, Expansion Bolts (Not provided) 
Metal	Sheet Metal Screws (Not provided) 
Wood	No. 6 Hex Head Screws (Provided) 

### TABLE OF CONTENTS

Getting Started .....	Page 2
Bracket Installation .....	Page 2
Inside Mount .....	Page 2
Outside Mount .....	Page 3
Shade Installation .....	Page 3
Removing the Shade .....	Page 3
Operation .....	Page 4
Hold Down Brackets (optional) .....	Page 4
Adjust Motor Limits on Primary Remote (if desired) .....	Page 5
Change Favorite Position (if one was set) .....	Page 5
Adjusting the Shade .....	Page 6
Charging the Motor .....	Page 6
Replacing the Battery in the Remote .....	Page 6
Solar Charge Unit (optional) .....	Page 7
Troubleshooting .....	Page 8
Care and Cleaning .....	Page 8
Child Safety .....	Page 8

## GETTING STARTED

All the required installation components are wrapped in your package along with these instructions. Check that the parts you have correspond to the parts shown below.

**Note:** Some parts may vary depending upon your chosen shade system or mounting option.

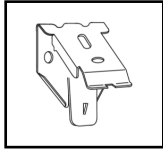

**Installation Brackets**

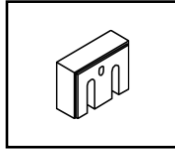

**Spacer Blocks**  
(optional)

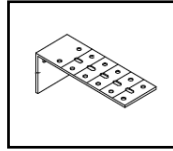

**Extension Bracket**  
(optional)

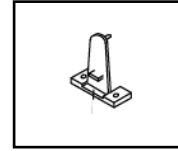

**Hold Down Brackets**  
(optional)

## Bracket Installation

Installation brackets may be used for **INSIDE** or **OUTSIDE** mounts.

**Mounting the brackets level is essential for proper operation of the shade.** Shim the brackets if necessary to achieve a level alignment.

The bracket requirements and placements are the same for inside and outside mounts. Refer to the following spacing diagram and bracket requirement chart.

Installation Bracket Requirement Chart	
Shade Width	Brackets Required
up to 38"	2
38-1/8" to 72"	3
over 72-1/8"	4

## Inside Mount

For inside mounts the installation brackets will be screwed in place through the top two holes of each bracket. Refer to the mounting depth chart:

	Minimum Depth	Fully Recessed
Wall Mounted Wand	1/2"	2-1/4"
Headrail Mounted Wand	1-1/4"	3"

**Note:** Prior to mounting the brackets, add any clearance depth required to avoid obstructions such as window cranks or handles.

### ATTACH THE BRACKETS:

1. Screw installation brackets through top two holes to desired window sill location.
  - Use a 3/32" drill bit to drill holes for the screws.
2. Ensure all brackets are level and aligned.

**IMPORTANT:** If you are fastening the installation brackets to drywall, be sure to use wall anchors and follow the instructions provided with the anchors. (Anchors not provided.)

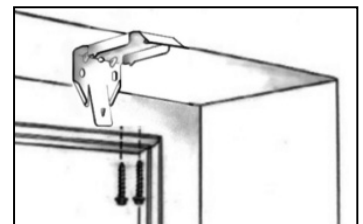

## Outside Mount

For outside mounts the standard installation brackets will be screwed in place through the two back holes of each bracket. Refer to the minimum surface height chart:

Minimum Height
1-1/2"

### ATTACH THE BRACKETS:

1. Screw standard brackets through two back holes to desired location.
  - Use a 3/32" drill bit to drill holes for the screws.
2. Ensure all brackets are level and aligned.

**IMPORTANT:** If you are fastening the installation brackets to drywall, be sure to use wall anchors and follow the instructions provided with the anchors. (Anchors not provided.)

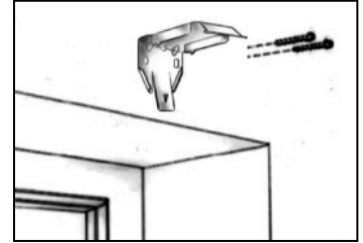

### EXTENSION BRACKETS (optional):

1. Position the extension brackets to the desired wall location.
2. The bracket tops must be aligned and level to one another.
3. Mount the extension brackets through the back holes with two screws.
4. Attach installation brackets to extension brackets with included screws & nuts.

**Note:** Use the same holes for all brackets to ensure even projection from the surface.



## Shade Installation

**NOTE:** If the Channel "0" was selected when ordering, then the shade will not be linked to a remote. The shade will need to be linked to a remote prior to installing in the window. See "Linking A Remote" in the OPERATION section of this guide.

The receiver wire is a small gray wire that comes out of the side of the motor closest to the end cap. Before mounting the headrail, make sure that the receiver wire is out of the headrail. For optimal performance, position the receiver wire so it extends into the room. Position the motor wire so that it comes out the back side of the shade.

### MOUNT THE HEADRAIL:

- With the front side of the shade facing you, Tilt the headrail slightly backward to angle the front inside lip to the brackets. (A)
- Push the headrail back and upward to snap in it into place (B).

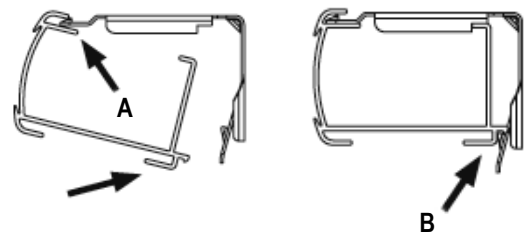

**Note:** Make sure that no fabric is pinched between the brackets and the headrail. Be sure the motor wire and charging port do not interfere with the bracket.

## Removing the Shade

To remove a shade, insert a screwdriver between the headrail and the bottom back of the bracket (tab which extends out slightly from each bracket).

Gently pry the screwdriver to release the bracket from the headrail. Take care not to damage the painted finish of the headrail.

As you release the brackets, support the headrail to keep it from falling.

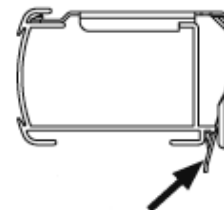

## Operation

The factory has set your shade to the channel that was specified at the time of order. If no channel was specified, the shade was set to operate on channel 1. If channel 0 was specified, the remote and shade will not be linked. A remote needs to be linked to the shade to continue. This should be done prior to installing the shade in the window.

### LINKING A REMOTE

**Important:** Please read through this section completely before beginning.

1. Select the channel that you want to link the shade to, using the **CHANNEL** selector buttons.
2. Press the **SETTING** button on the motor until the motor starts to beep. Release the button immediately after the beeps start. The motor will make 4 fast beeps followed by 5 long beeps. Press the **CONFIRM** button on the remote anytime during the series of long beeps. It must be pressed before the last long beep. The motor will respond with 3 fast beeps confirming that the shade has been linked.
3. Repeat step 2 for all shades that will be controlled by the same channel (It is not recommended to put more than one shade on a channel).
4. Repeat steps 1-3 to link remaining shades to the rest of the channels.

All shades linked to a remote will also automatically be programmed to the "ALL" channel.

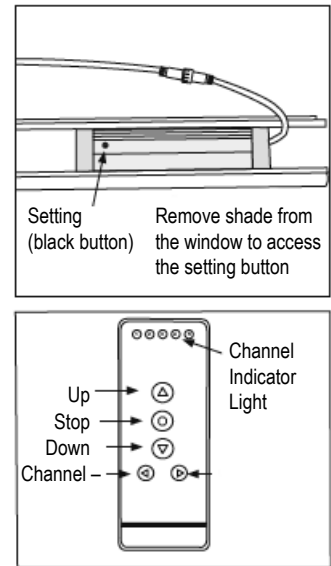

### OPERATING THE SHADE

Select the desired channel with the **CHANNEL** buttons. The channel indicator light will illuminate the channel that is on. If all 5 lights are lit the remote will control all 5 channels at once.

- Tapping the **UP** or **DOWN** buttons for less than 2 seconds will move the shade in short steps. Holding the **UP** or **DOWN** buttons down for more than 2 seconds before releasing will operate the shade in the faster standard speed.
- Press the **UP** or **DOWN** buttons to raise or lower the shade.
- Press the **STOP** button to stop the shade anywhere along the travel.

### SETTING AND USING A FAVORITE POSITION

Use the **UP** or **DOWN** buttons to position the shade at the desired "favorite" position.

First press and hold the **LIMIT** button on the back of the remote with a small screwdriver or tip of a pen.

While holding the **LIMIT** button press and hold the **UP** button. Release both buttons when the motor beeps.

With the shade at either the upper or lower limit, simply press the **STOP** button to bring the shade to the "favorite" position. To go to the "favorite" position from any other location, make sure the shade has been stopped for at least three seconds before pressing the **STOP** button.

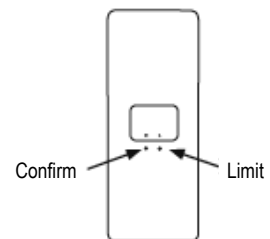

## Hold-Down Brackets (optional)

- Lower the shade and place the hold down pins into the bottomrail end caps.
- Mark the hold down bracket locations on the mounting surface.
- With the brackets level, attach them using two screws.

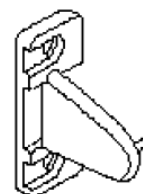

## Adjust Motor Limits on Primary Remote (if desired)

The lower and upper limits have been set at the factory. If you need to make adjustments to the limits, follow the instructions below.

**Note:** When clearing the factory set limits, both the upper and lower limits will need to be reset.

Use the **CHANNEL** button to select the channel for the shade that needs to be adjusted. Then follow the directions below. If only adjusting one shade on a channel, unplug the other shades.

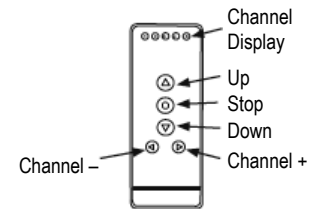

### SET LOWER LIMIT

	Operation	Result
1	Hold <b>LIMIT</b> button down	The motor begins to beep
2	Release the button after beeping starts	The motor is ready for limit setting
3	Press <b>DOWN</b> button	The motor will go down continuously
4	When the motor is close to the desired lower limit, press <b>STOP</b> button on the remote	The motor stops running
5	Press either the <b>UP</b> or <b>DOWN</b> button	The motor runs step by step to adjust lower limit accurately
6	Confirm the setting by pressing the <b>CONFIRM</b> button on the remote	The motor will beep and the lower setting is completed

### SET UPPER LIMIT

	Operation	Result
1	Press <b>UP</b> button on the remote transmitter	The motor will go up continuously
2	When the motor is close to the desired upper limit, press <b>STOP</b> button on the remote	The motor stops running
3	Press either the <b>UP</b> or <b>DOWN</b> button	The motor runs step by step to adjust upper limit accurately
4	Confirm the setting by pressing the <b>CONFIRM</b> button on the remote	The motor will beep and the upper setting is completed

## Change Favorite Position (if one was set)

Use the **UP** or **DOWN** buttons to position the shade at the desired “favorite” position. First press and hold the **LIMIT** button on the back of the remote with a small screwdriver or tip of a pen. While holding the **LIMIT** button press and hold the **UP** button. Release both buttons when the motor beeps.

To erase the “favorite” position bring the shade to the **upper** limit. Press and hold the **LIMIT** button on the back of the remote, then press and hold the **UP** button. Release both buttons when the motor beeps.

## Adjusting the Shade

- Raise and lower the shade several times.
- If the length is incorrect or the bottom rail is not level, use the following steps to correct.

### BOTTOMRAIL SHADE ADJUSTMENT

1. Lift bottomrail on the side to be adjusted. This will take the weight off the cord.
2. Use a screwdriver or dime.
  - Turn screw clockwise to lift that side of the shade.
  - Turn screw counter clockwise to lower that side of the shade.
  - Half a revolution is 1/4" adjustment (maximum adjustment is 1/2").

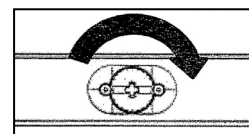
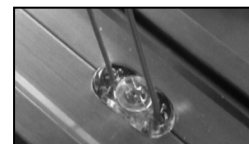
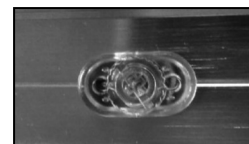

Lift Shade Side

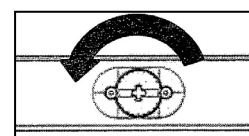

Lower Shade Side

## Charging the Motor

When the shade begins to operate slower than normal it is time to charge the motor.

Plug the 8.4v charger into the charging wire. The charging wire is attached to the back of the headrail at the left end.

Plug the charger into an electrical outlet.

A red light on the charger indicates that the motor is charging.

To fully charge the batteries, allow the batteries to charge for 1 hour after the light on the charger turns green.

A typical charge cycle can take between 4-6 hours.

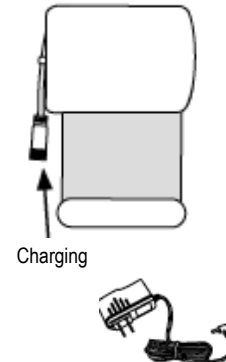

## Replacing the Battery in the Remote

Remove the battery tray from the remote by inserting a fingernail into the indentation on the back of the remote. To avoid the battery falling out of the remote, remove the tray while the remote is face up.

Insert the new battery (CR2430 lithium) into the battery tray so that the writing is facing up when the remote is face up. Slide the tray back into the remote.



## Solar Charge Unit (optional)

### DETERMINE SOLAR RECHARGE UNIT PLACEMENT

The solar recharge unit should be placed where it gets the maximum amount of sunlight per day. **In most cases this can be achieved by mounting the unit directly to the glass with double sided tape.**

Brackets are provided if attaching to the glass is not possible. The brackets may be mounted several different ways depending on the application (window depth, window width, etc.).

The unit requires 19" minimum window width to mount horizontally

### MOUNTING OPTIONS

#### Inside Mount

Bracket can be mounted behind or next to shade mounting bracket.

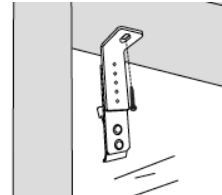

#### Inside Mount Extended

Bottom portion of the bracket may be lowered if needed for more sun exposure.

Bracket can be mounted behind or next to shade mounting bracket.

**Note:** only two of the holes are threaded.

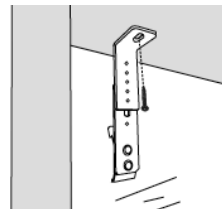

#### Inside Mount with Top Reversed

The top portion of the bracket may be reversed if necessary depending on space.

Bracket can be mounted behind or next to shade mounting bracket.

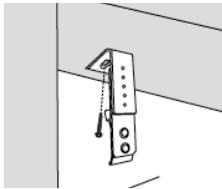

#### Outside Mount

This method will provide the least amount of sun exposure.

Bracket can be mounted next to shade mounting bracket.

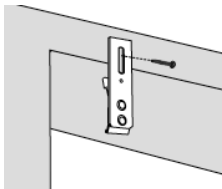

### INSTALL SOLAR RECHARGE UNIT

**Tape Method** - Cut the tape to fit inside the white border as shown. Clean the ends of the solar panel where the tape will go with rubbing alcohol. When dry, remove the release liner from one side of the double sided tape and adhere them to face of the panel. Make sure to put the tape on the face (black side) of the panel.

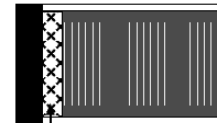

Double Sided Tape

Clean the window surface with rubbing alcohol. When dry, remove the release liners and attach the solar panel to the glass, pressing firmly to adhere.

**Bracket Method** - If using brackets, set the bottom groove of the unit onto the bottom bracket hook. Then press the top of the unit until it snaps into place. If space is limited it may be easier to attach the brackets to the solar unit before screwing the brackets in place.

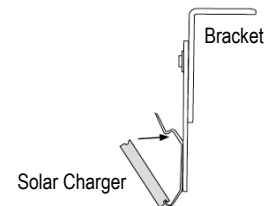

### CONNECT SOLAR RECHARGE UNIT TO MOTOR

After the shade is installed, plug the solar unit into the motor recharge port.

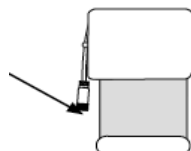

## TROUBLESHOOTING

### THE MOTOR DOES NOT WORK.

- Check that the power source and motor are connected properly.
- Check that the rechargeable battery pack is connected properly and charged.

### THE MOTOR CONTINUES TO RUN IN ONE DIRECTION.

- The limit setting was unsuccessful and needs to be reset.

### THE INDICATOR LIGHT ON THE REMOTE DOES NOT SHINE OR THE REMOTE-CONTROL RANGE BECOMES SHORTER.

- Recharge the battery in the remote (CR2430 lithium).

## CARE AND CLEANING

Honeycomb shades are made of an anti-static, dust resistant fabric which repels dirt and dust. For most of these fabrics, the following options are available if your shade needs cleaning.

**DUSTING:** Regular light dusting with a feather duster is all the cleaning that is needed in most circumstances.

**VACUUMING:** Use a hand-held vacuum with low suction for more thorough dust removal.

**SPOT CLEANING:** Use the following steps for spot cleaning: (1) Prepare a solution of warm water and mild dish-washing detergent. (2) Dampen a clean cloth in the solution and ring it out. (3) Dab the spot with the dampened cloth until it is gone. **DO NOT RUB THE FABRIC.** (4) Allow the shade to dry in the completely lowered position.

**CAUTION:** *Avoid creasing Blackout fabrics during cleaning.*

**DEEP CLEANING:** Use the following steps for deep cleaning: (1) Immerse shade in basin or bathtub filled with warm water and mild detergent. (2) Rinse with clean water. (3) Fully raise shade and tilt to eliminate excess water, (4) Reinstall damp shade, lower it, and let it dry completely.

**CAUTION:** *Do not immerse Blackout fabrics. Do not immerse the headrail or any fabric-wrapped rail.*

**ULTRASONIC CLEANING:** Standard shades, except those made with Blackout Lining can be ultrasonically cleaned by a professional.

- Specify that a mild detergent be used.
- Never immerse the headrail or any fabric-wrapped rail in the solution.
- Dry the shade completely in the lowered position.

**CAUTION:** *Do not ultrasonically clean Blackout fabrics. Do not immerse headrail.*

## CHILD SAFETY

Young children can **STRANGLE** in cord loops and in the loop above the cord stop. They can also wrap cords around their necks and **STRANGLE**.

- Always keep cords out of children's reach.
- Move cribs, playpens and other furniture away from cords.  
Children can climb furniture to get to cords.
- Do not tie cords together.
- Make sure cords do not twist together and create a loop.



### SAFETY LABELS

In compliance with WCMA/ANSI safety standards the warning labels on the bottom rail are designed to be permanent. **DO NOT** remove the permanent warning label on the bottom rail. This assures that future owners of this product will be aware of potential dangers associated with this shade.





# INSTALLATION INSTRUCTIONS

## HONEYCOMB & HYBRID PLEAT SHADES

### SIMPLICITY RECHARGEABLE MOTORIZATION



#### Top-Down / Bottom-Up

Thank you for your purchase. This shade has been custom built for you from the highest quality materials. To avoid errors and save valuable time, please read these instructions before installing your new shade.

## TOOLS YOU WILL NEED

1. Pencil or Marker
2. Measuring Tape
3. Phillips Screwdriver
4. Carpenter's Level
5. Power Drill
6. Mounting Fasteners



Mounting Surface	Fastener
Drywall, Plaster	Wall Anchors, Expansion Bolts (Not Provided) 
Metal	Sheet Metal Screws (Not Provided) 
Wood	No. 6 Hex Head Screws (Provided) 

## GETTING STARTED

All the required installation components are wrapped in your package along with these instructions. Check that the parts you have correspond to the parts shown below. *NOTE: Some parts may vary depending upon your mounting option.*

### PARTS

- Installation Brackets .....
- Spacer Blocks (optional) .....
- Extension Bracket (optional) .....
- Hold Down Brackets (optional) .....
- Screws .....

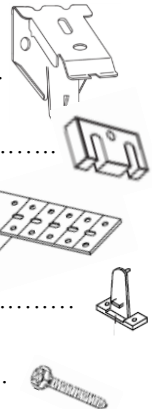

# MOUNTING THE BRACKETS

The installation brackets may be used for **INSIDE** or **OUTSIDE** mounts.

**Mounting the brackets level is essential for proper operation of the shade.** Shim the brackets if necessary to achieve a level alignment.

The bracket requirements and placements are the same for inside and outside mounts. Refer to the following spacing diagram and bracket requirement chart.

**Installation Bracket Requirement Chart**

Shade Width	Brackets Required
up to 38"	2
38-1/8" to 72"	3
Over 72-1/8"	4

## **INSIDE MOUNTS:**

For inside mounts the installation brackets will be screwed in place through the top two holes of each bracket. Refer to the mounting depth chart below.

	Minimum Depth	Fully Recessed
<b>Over 36" width</b>	3/4"	2-1/4"
<b>Under 36" width</b>	1-1/4"	3"

Note: Prior to mounting the brackets, add any clearance depth required to avoid obstructions such as window cranks or handles.

## **ATTACH THE BRACKETS:**

- Screw installation brackets through top two holes to desired window sill location.
- Ensure all brackets are level and aligned.

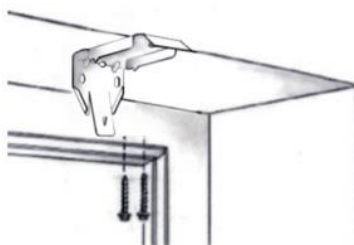

## **OUTSIDE MOUNTS:**

**NOTE:** Shades under 36" wide have an EXTERNAL battery pack that attaches to the back of the headrail and spacer blocks will be needed. Shades 36" and wider have an INTERNAL battery pack concealed with the headrail.

For outside mounts the standard installation brackets will be screwed in place through the two back holes of each bracket. Refer to the minimum surface height chart below.

Minimum Flat Vertical Surface Height
1-1/2"

### ATTACH THE BRACKETS:

- Screw standard brackets through two back holes to desired location.
- Ensure all brackets are level and aligned.

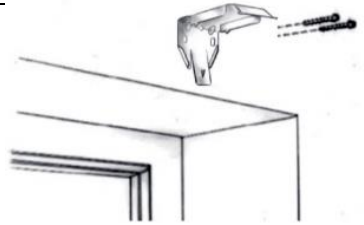

### EXTENSION BRACKETS (optional):

- Position the extension brackets to the desired wall location.
- The bracket tops must be aligned and level to one another.
- Mount the extension brackets through the back holes with two screws.
- Attach installation brackets to extension brackets with included screws & nuts.

Note: Use the same holes for all brackets to ensure even projection from the surface.



## SHADE INSTALLATION

The receiver wire is a small gray wire that comes out of the side of the motor closest to the end cap. Before mounting the headrail, make sure that the receiver wire is out of the headrail. For optimal performance, position the receiver wire so it extends into the room.

Position the motor wire so that it comes out the back side of the shade.

### MOUNT THE HEADRAIL:

- With the front side of the shade facing you...
- Tilt the headrail slightly backward to angle the front inside lip to the brackets. (A)
- Push the headrail back and upward to snap in it into place (B).

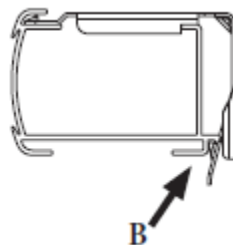
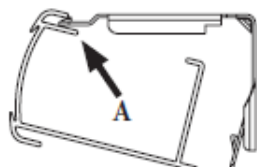

Make sure that no fabric is pinched between the brackets and the headrail.

Be sure the motor wire and charging port do not interfere with the bracket.

## REMOVING THE SHADE

To remove a shade, insert a screwdriver between the headrail and the bottom back of the bracket (tab which extends out slightly from each bracket).

Gently pry the screwdriver to release the bracket from the headrail. Take care not to damage the painted finish of the headrail.

As you release the brackets, support the headrail to keep it from falling.

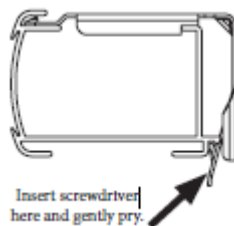

# OPERATION

The factory has set your shade to the channel that was specified at the time of order. If no channel was specified, the shade was set to operate on channel 1. If channel 0 was specified, the remote and shade will not be linked. A remote needs to be linked to the shade to continue. This should be done prior to installing the shade in the window.

## The Remote

The remote control has multiple channels. Before linking the remote, determine which shade(s) you want on which channel. The remote has 14 channels. All shades linked to a remote will also automatically be programmed to the "ALL" channel.

### Linking a Remote to the Shade

*(one shade at a time)*

1. Select the channel that you want to link the shades to, using the **CHANNEL** selector button.

2. Activate the Top Down/Bottom Up function for that channel by pressing the **RAIL SELECTOR** and **DOWN** buttons at the same time until a rail selector # shows up on the left side of the screen.



3. Use the **RAIL SELECTOR** button to choose rail "1"

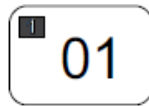

4. Press the **SETTING** button on the right motor until the motor starts to beep. Release the button immediately after the beeps start. The motor will make 4 fast beeps followed by 5 long beeps.

Press the **CONFIRM** button on the remote anytime during the series of long beeps. It must be pressed before the last long beep. The motor will respond with 3 fast beeps confirming that the shade has been linked.

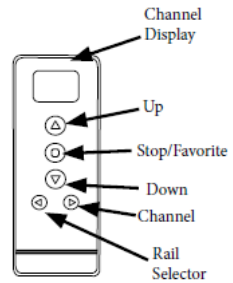

**Remote - Front**

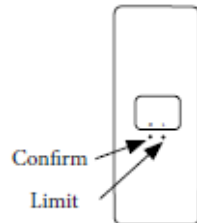
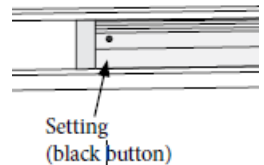

**Remote - Back**

5. Repeat step 4 for all shades that will be controlled by the same channel (*it is not recommended to put more than one shade on a channel*).

6. Repeat steps 1-5 to link remaining shades to the rest of the channels.

## Operating the Shade

1. Select the desired channel with the **CHANNEL** button.
2. Use the **RAIL SELECTOR** to choose which rail you want to move.

When a 1 is displayed, the middle rail will operate.

When a 2 is displayed, the bottom rail will operate.

When a 3 is displayed both rails will operate at the same time. 3 can also be used for a "favorite" position.

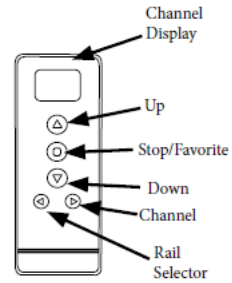

3. Press the **UP** or **DOWN** buttons to raise or lower the rail(s) selected.
4. Press the **STOP** button to stop the shade anywhere along the travel.

## Unlinking Shades

1. Press and hold the **CONFIRM** button. The shade will give a series of fast beeps (4 beeps/pause/4 beeps/pause/8 beeps).
2. When the series of beeps is complete release the **CONFIRM** button.

All shades previously linked to the selected channel will now be unlinked. Follow the steps under **Linking a Remote to the Shade** to link only the shade that you are setting a favorite on.

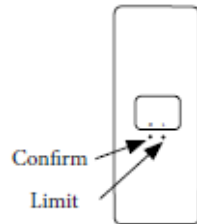

# SETTING & USING FAVORITES

## Setting a Favorite

1. Use the **RAIL SELECTOR** button to choose rail no. 2.

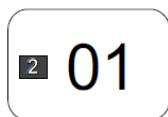

2. Use the **UP** or **DOWN** buttons to position the bottom rail at the desired "favorite" position.  
Press **STOP**.

3. Use the **RAIL SELECTOR** button to choose rail no. 1.

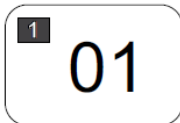

4. Use the **UP** or **DOWN** buttons to position the middle rail at the desired "favorite" position.  
Press **STOP**.

5. Use the **RAIL SELECTOR** button to choose no. 3 in the display.



6. While holding the **LIMIT** button, quickly press and hold the **UP** button. Release both buttons when the shade beeps.

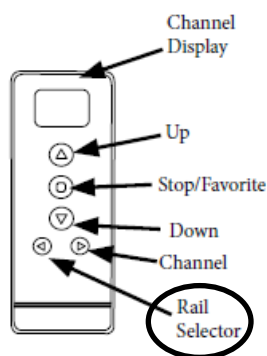

## Using a Favorite

Use the **RAIL SELECTOR** button to choose no. 3 in the display.

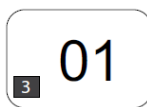

Press the **STOP/FAVORITE** button to bring the shade to the "favorite" position. Both rails will move to the "favorite" position.

Make sure the shade has been stopped for at least three seconds before pressing the **STOP/FAVORITE** button.

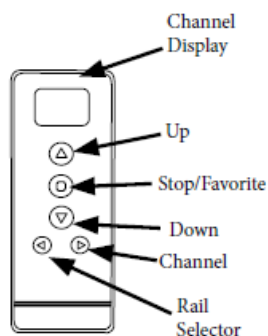





## ADJUST MOTOR LIMITS ON PRIMARY REMOTE (If Desired)

The lower and upper limits have been set at the factory. If you need to make adjustments to the limits, follow the instructions below.

**NOTE:** When clearing the factory set limits, both the upper and lower limits will need to be reset.

Use the **CHANNEL** button to select the channel for the shade that needs to be adjusted. If there is only a single shade on the channel, proceed to setting limits.

If there is more than one shade on the channel, all shades will need to be unlinked. Press and hold the **CONFIRM** button. The shade will give a series of fast beeps (4 beeps / pause / 4 beeps / pause / 8 beeps)

When the series of beeps is complete release the **CONFIRM** button. All shades previously link to the channel will now be unlinked.

Follow the steps to link the remote only on the shade that needs to be adjusted.

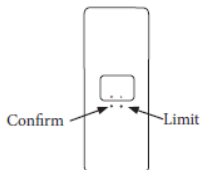

## Adjusting the Motor Limits

1. Use the **RAIL SELECTOR** button to choose rail no. 1.

1 01

2. Use the **UP** button to raise the middle rail to the head rail and then press **STOP**. The shade will now move in short steps for fine adjustment.

3. Use the **RAIL SELECTOR** button to choose rail no. 2.

2 01

4. Use the **UP** button to raise the bottom rail near the top. Press **STOP**. The shade will now move in short steps for fine adjustment. Use the **UP** button to raise the rail until the fabric stack is compressed.

5. Hold the **CONFIRM** button until the shade beeps once. This sets the upper limit.

6. Use the **DOWN** button to lower the bottom rail near the desired lower limit. Press **STOP**.

7. Use the **UP** or **DOWN** buttons to accurately adjust the position of the bottom rail.

8. Hold the **CONFIRM** button until the shade beeps once. This sets the lower limit.

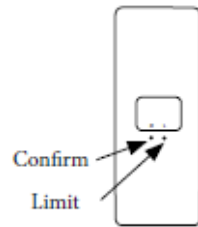
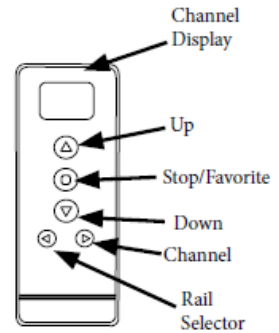

# THE REMOTE

## Replace Original Remote, Add Additional Remote, or Add a Shade to an Additional Channel

1. Select the channel that you want to program using the **CHANNEL** selector button.
2. Activate the Top Down/Bottom Up function for that channel by pressing the **RAIL SELECTOR** and **DOWN** buttons at the same time until a rail selector # shows up on the left side of the screen.
3. Use the **RAIL SELECTOR** button to choose no. 1 in the display.

4. Press the **SETTING** button on the motor until the motor starts to beep. Release the button immediately after the beeps start. The motor will make 4 fast beeps followed by 5 long beeps. Press the **CONFIRM** button on the remote anytime during the series of long beeps. It must be pressed before the last long beep. The motor will respond with 3 fast beeps confirming that the shade has been linked.



Setting  
(black button)

Remove shade  
from the window  
to access the  
setting button

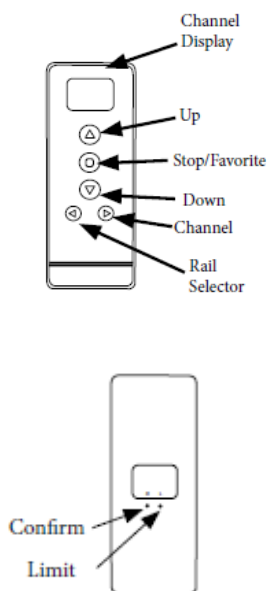

5. Repeat this step for all shades that will be controlled by the same channel. It is recommended to link only one shade per channel. You **can not mix** top down/bottom up shades and bottom up only shades on the same channel.

## Remove a Shade from a Remote or Channel and Link it to a Different Remote or Channel

1. Select the channel that you want to program using the **CHANNEL** selector button. **NOTE:** All shades on that channel will be unlinked.

2. Press and hold the **CONFIRM** button. The shade will give a series of fast beeps (4 beeps / pause / 4 beeps / pause / 8 beeps) When the series of beeps is complete release the **CONFIRM** button

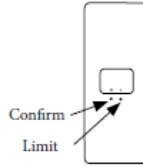

3. Link the motor to a new remote or channel

4. Follow the steps for replacing the remote detailed in this guide.

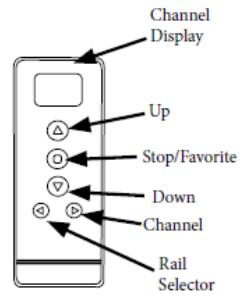

## HOLD-DOWN BRACKETS (OPTIONAL)

- Lower the shade and place the hold down pins into the bottomrail end caps.
- Mark the hold down bracket locations on the mounting surface.
- With the brackets level, attach them using two screws.



## ADJUSTING THE SHADE

- Raise and lower the shade several times.
- If the length is incorrect or the bottomrail is not level, use the following steps to correct.

### BOTTOMRAIL SHADE ADJUSTMENT:

- Lift bottomrail on the side to be adjusted. This will take the weight off the cord.
- Use a screwdriver or dime.
  - Turn screw clockwise to lift that side of the shade
  - Turn screw counter clockwise to lower that side of the shade
  - Half a revolution is  $\frac{1}{4}$ " adjustment (maximum adjustment is  $\frac{1}{2}$ " )

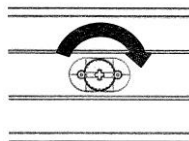
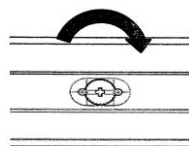
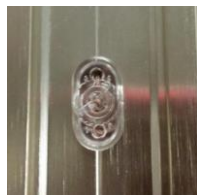

## CHARGING THE MOTOR

When the shade begins to operate slower than normal it is time to charge the motor.

Plug the 8.4v charger into the charging wire. The charging wire is attached to the back of the headrail at the left end. If a solar panel is being used, unplug it from the charging wire.

Plug the charger into an electrical outlet.

A red light on the charger indicates that the motor is charging.

To fully charge the batteries, allow the batteries to charge for 1 hour after the light on the charger turns green. A typical charge cycle can take between 4-6 hours.

Do not leave the charger plugged in for more than 24 hours. This could prematurely age the battery.

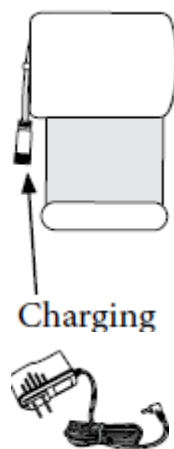

## REPLACING THE BATTERY IN THE REMOTE

When the display on the remote will not display or the range of the remote becomes shorter, it is time to replace the battery in the remote.

Remove the battery tray from the remote by inserting a fingernail into the indentation on the back of the remote. To avoid the battery falling out of the remote, remove the tray while the remote is face up.

Insert fingernail here

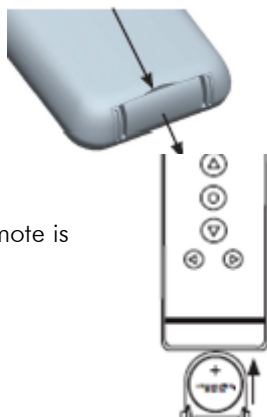

Insert the new battery (CR2430 lithium) into the battery tray so that the writing is facing up when the remote is face up. Slide the tray back into the remote.

# SOLAR RECHARGE UNIT (Optional)

## DETERMINE SOLAR RECHARGE UNIT PLACEMENT

The solar recharge unit should be placed where it gets the maximum amount of sunlight per day. **In most cases this can be achieved by mounting the unit directly to the glass with double sided tape.**

Brackets are provided if attaching to the glass is not possible.

The brackets may be mounted several different ways depending on the application (window depth, window width, etc.).

The unit requires 19" minimum window width to mount horizontally

## MOUNTING OPTIONS

**Inside Mount** Bracket can be mounted behind or next to shade mounting bracket.

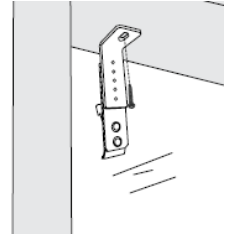
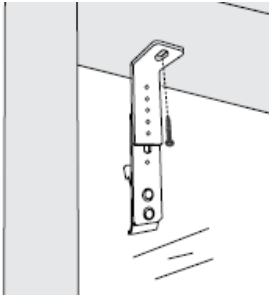

**Inside Mount Extended** Bottom portion of the bracket may be lowered if needed for more sun exposure.

Bracket can be mounted behind or next to shade mounting bracket.

Note: only two of the holes are threaded.

**Inside Mount with Top Reversed** The top portion of the bracket may be reversed if necessary depending on space. Bracket can be mounted behind or next to shade mounting bracket.

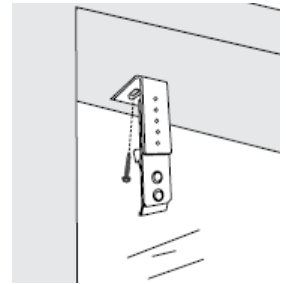

## Outside Mount

This method will provide the least amount of sun exposure. Bracket can be mounted next to shade mounting bracket.

## INSTALL SOLAR RECHARGE UNIT

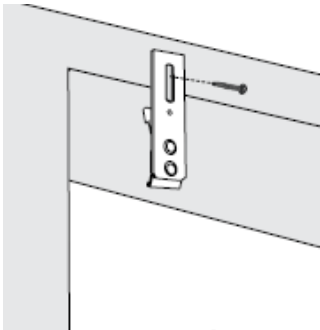

Tape Method - Cut the tape to fit inside the white border as shown. Clean the ends of the solar panel where the tape will go with rubbing alcohol. When dry, remove the release liner from one side of the double sided tape and adhere them to face of the panel. Make sure to put the tape on the face (black side) of the panel.

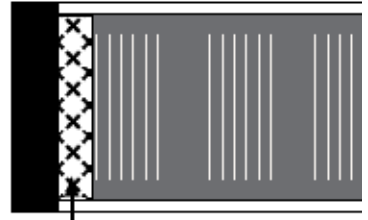

Double sided tape

Clean the window surface with rubbing alcohol. When dry, remove the release liners and attach the solar panel to the glass, pressing firmly to adhere.

Bracket Method - If using brackets, set the bottom groove of the unit onto the bottom bracket hook. The press the top of the unit until it snaps into place. If space is limited it may be easier to attach the brackets to the solar unit before screwing the brackets in place.

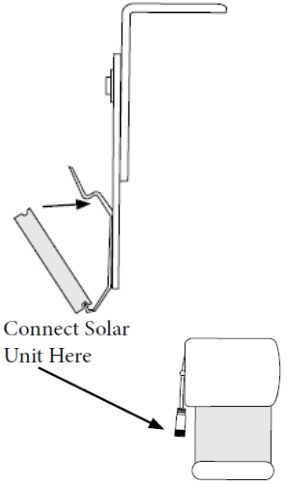

### CONNECT SOLAR RECHARGE UNIT TO MOTOR

After the shade is installed, plug the solar unit into the motor recharge port.





## CLEANING INSTRUCTIONS

Honeycomb shades are made of an anti-static, dust resistant fabric which repels dirt and dust. For most of these fabrics, the following options are available if your shade needs cleaning.

**DUSTING:** Regular light dusting with a feather duster is all the cleaning that is needed in most circumstances.

**VACUUMING:** Use a hand-held vacuum with low suction for more thorough dust removal.

**SPOT CLEANING:** Use the following steps for spot cleaning: (1) Prepare a solution of warm water and mild dishwashing detergent. (2) Dampen a clean cloth in the solution and ring it out. (3) Dab the spot with the dampened cloth until it is gone. **DO NOT RUB THE FABRIC.** (4) Allow the shade to dry in the completely lowered position.

**CAUTION:** Avoid creasing Blackout fabrics during cleaning.

**DEEP CLEANING:** Use the following steps for deep cleaning: (1) Immerse shade in basin or bathtub filled with warm water and mild detergent. (2) Rinse with clean water. (3) Fully raise shade and tilt to eliminate excess water, (4) Reinstall damp shade, lower it, and let it dry completely.

**CAUTION:** Do not immerse Blackout fabrics. Do not immerse the headrail or any fabric-wrapped rail.

**ULTRASONIC CLEANING:** Standard shades, except those made with Blackout Lining can be ultrasonically cleaned by a professional.

- Specify that a mild detergent be used.
- Never immerse the headrail or any fabric-wrapped rail in the solution.
- Dry the shade completely in the lowered position.

**CAUTION:** Do not ultrasonically clean Blackout fabrics. Do not immerse headrail.

# WARNING

## CHILD SAFETY

Inner or exposed cords can pull out to form a loop, which can STRANGLE a young child.



- Children can climb furniture to access inner or exposed cords. Move cribs, playpens, and other furniture away from window coverings.
- Always keep cords out of the reach of children.



## CANADIAN RESIDENTS ONLY:



For more safety information  
call 1-866-662-0666 or go to  
[www.healthcanada.gc.ca/blindcords](http://www.healthcanada.gc.ca/blindcords)



## WARRANTY INFORMATION

Lifetime Limited Warranty covering our Custom Made Shades

We extend this lifetime limited warranty to the original purchaser. This warranty applies only to manually operated Custom Products properly installed in the window, door or interior area for which they were intended. Installation of the product must be in accordance with accompanying instructions. The product cannot be modified. It is the purchaser's responsibility to maintain and clean the product in compliance with the instruction provided. The product must be used only in the window for which it was purchased. Damage to the product resulting from misuse, abuse, direct exposure to salty air or discoloration due to sunlight or the passage of time is not covered by this warranty.

This warranty does not apply to conditions caused by normal wear and tear upon the product. This warranty is exclusive and in lieu of all other obligations, liabilities or warranties. In no event shall the Manufacturer be liable for incidental or consequential damages or for any other direct or indirect damage, loss, cost, expense or fee. Some states do not allow the exclusion or limitation of incidental or consequential damages, so this exclusion or limitation may not apply to you.

In the event of a defect under this warranty, we will repair or replace the product, at our option, provided it is returned to our store. Our warranty obligation excludes shipping charges and labor costs for measuring and installation. Repairs will be made with like or similar parts. This warranty gives you specific legal rights, and you may have other rights which vary from state to state.

Notes: Motorization Systems are warranted for five years from the date of purchase. Specialty Blinds and Shades are warranted for one year from the date of purchase.

This warranty does not apply to Commercial Orders.

C8-20-4480 • 1/19



C8-20-4480