

*Cellular Shades*

**Motorized Wand**

 **SelectBlinds®**



**Installation & Care Instructions**

152730  
4/19/2017

## GETTING STARTED

A few simple tools are required:

- Measuring tape
- Power drill, drill bits
- 1/4" Hex head and/or Phillips driver bit
- Pencil

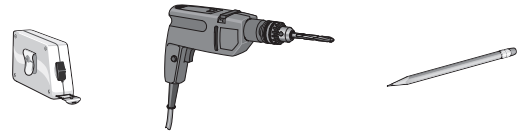

Additional fasteners other than those sent with your shade may be required depending on the mounting surface. Wallboard and plaster require the use of anchors such as expansion or toggle bolts. Brick, tile or stone need special plugs and drill bits. Remember to always pre-drill holes in wood to avoid splitting.

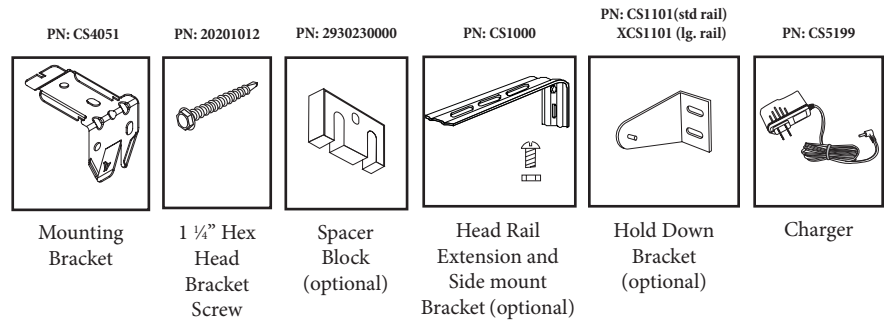

## STEP 1: BRACKET INSTALLATION

Shades are shipped with the required number of brackets for proper installation. End brackets should be located approximately 3" from either end. Depending on the width of the shade, additional brackets may be necessary, evenly spaced between the two end brackets.

Using the installation bracket as a template, measure to the center of the bracket and mark the hole locations with a pencil for drilling.

Brackets must be in line and level. Shim brackets on inside mounts if necessary. The head rail must be level for the shade to operate properly.

Shade Width	# of Brackets
Up to 40"	2
>40" - 72"	3
>72" - 84"	4
>84" and up	5

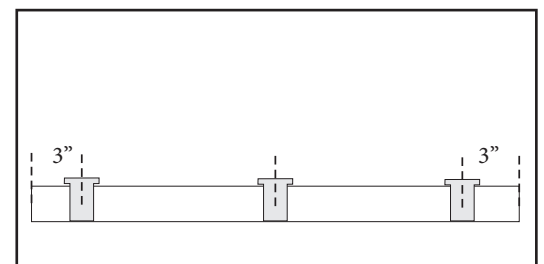
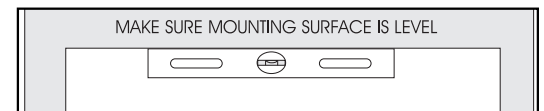

## INSIDE MOUNT

The minimum mounting depth for an inside mount is  $\frac{1}{2}$ ".

A minimum of  $2\frac{1}{4}$ " is needed to fully recess the shade.

Make sure that the brackets are level and aligned.

Attach using two screws when possible. One screw is sufficient on shallow mounts.

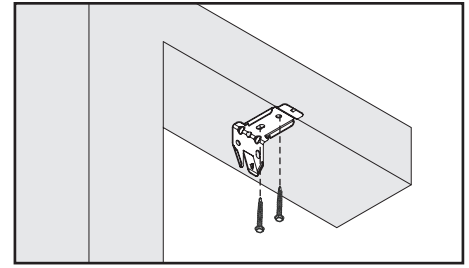

**Inside Mount**

Shallow Mount - Minimum  $\frac{1}{2}$ " surface

Flush Mount - Minimum  $2\frac{1}{4}$ " surface

## OUTSIDE MOUNT

The minimum mounting height for outside mounted shades is  $\frac{7}{8}$ ".

Make sure that the brackets are level and aligned.

Attach using two screws.

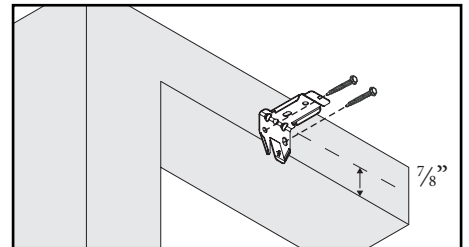

**Outside Mount**

Minimum  $\frac{7}{8}$ " surface

## SPACER BLOCKS (OPTIONAL)

Each spacer block projects brackets  $\frac{1}{2}$ " away from mounting surface.

Make sure that the brackets are level and aligned.

Attach using two screws. Screws should be long enough to secure the bracket to the mounting surface.

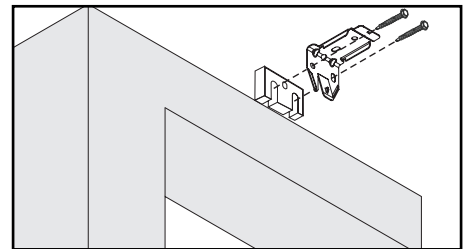

**Outside Mount with Spacer Blocks**

## EXTENSION BRACKETS (OPTIONAL)

Optional extension brackets are used to project the back of the shade up to  $2\frac{3}{8}$ " from the mounting surface.

Attach the mounting bracket to the extension bracket with the nut and bolt provided.

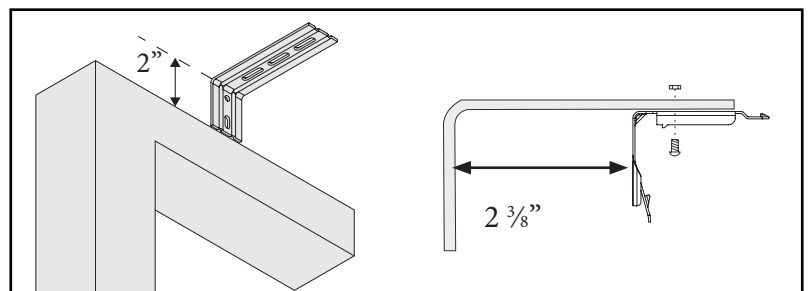

**Outside Mount with Extension Brackets**

Minimum  $2$ " surface

## SIDE MOUNT (OPTIONAL)

Measure from window sill up to desired mounting position on each side of the window frame. Mark position.

Mount side mount brackets on each side of window frame as shown. Make sure to confirm that head rail will sit perfectly level.

Once side mount brackets are installed and properly positioned, attach the mounting brackets using the nuts and bolts provided.

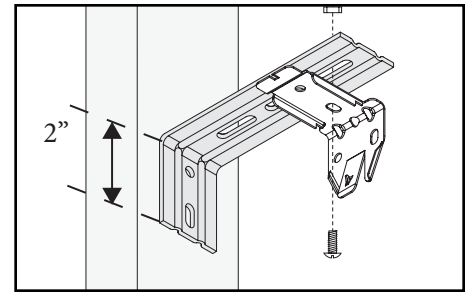

**Side Mount**  
Minimum 2" surface

## STEP 2: ATTACH WAND

Remove the wand hanger from the head rail. Squeeze the bottom on both sides to release the lower legs (A). Lift up slightly and remove the hanger post from the top hole in the headrail.

Insert the post on the hanger into the hole on the internal L hanger (B).

Insert the post into the top hole in the headrail first (C). Then, squeeze the bottom of the hanger on both sides so that the lower legs will fit into the hole in the headrail. Make sure that the wires are not in the way of the legs.

Plug the control wire into the wand wire (D). The plugs will only fit together one way.

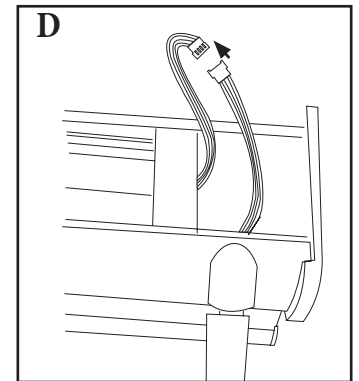
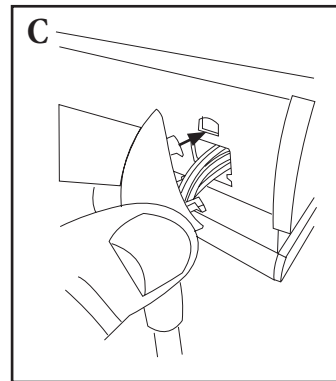
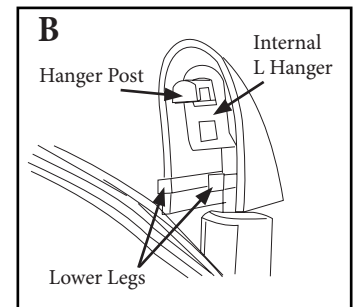
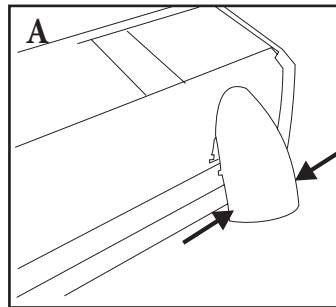

## STEP 3: SHADE INSTALLATION

Position the head rail with the front lip (A) resting on the top hooks of all the brackets.

While holding the fabric out of the way, push the bottom of the head rail upward and toward the window until the groove at the bottom of the head rail snaps into place, (B) as shown.

Make sure that no fabric is pinched between the brackets and the head rail.

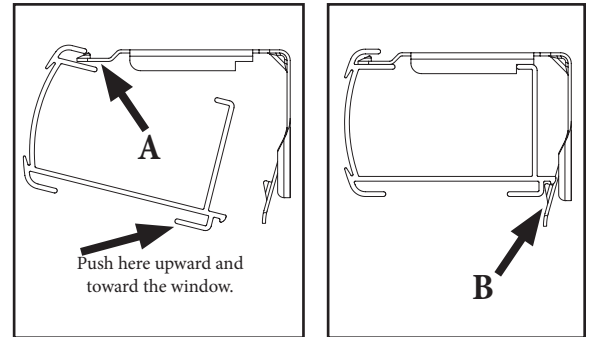

## OPERATION

Press the **DOWN** or **UP** button to lower or raise the shade. Press the **STOP/FAVORITE** to stop the shade at the desired position.

### Touch & Go Feature:

To fully raise or lower the shade, simply press the **UP** or **DOWN** button and then release. The shade will automatically stop when it reaches the upper or lower limit. *(If the upper or lower limits are not set at the desired positions, see the Adjust Motor Limits section on the next page)*

Note: Upper and lower limits stops are set at the factory. An intermediate, or “favorite” position is not set at the factory. See page 6 for more information.

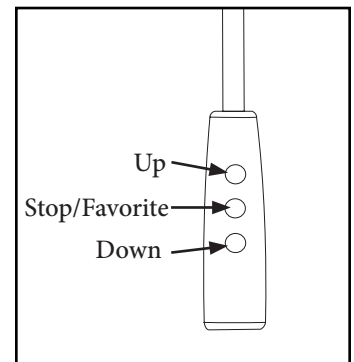

## ADJUST MOTOR LIMITS (IF DESIRED)

The upper and lower limits have been set at the factory. If you need to make adjustments to the limits, follow the instructions below.

Press the **SETTING** button on the back of the wand and hold it in until the motor stops beeping. This will clear both the upper and lower factory limits as well as a favorite if one was set.

**Set Upper Limit** - Press the **UP** button to get the shade close to the desired upper limit and then press the **STOP** button to stop the shade. Tap the **UP** or **DOWN** button to move the shade to the desired position. To save the location, press the **SETTING** button until the motor beeps.

**Set Lower Limit** - Press the **DOWN** button to get the shade close to the desired lower limit and then press the **STOP** button to stop the shade. Tap the **UP** or **DOWN** button to move the shade to the desired position. To save the location, press the **SETTING** button until the motor beeps.

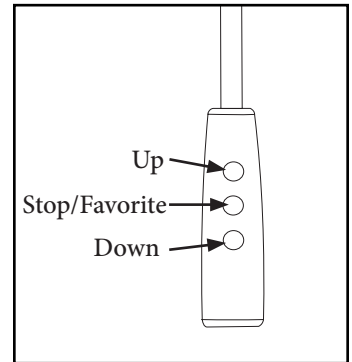
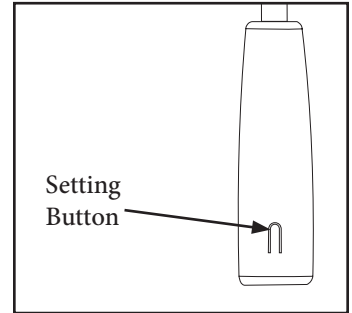

## FAVORITE POSITION

### SETTING AND USING A FAVORITE POSITION

Use the **UP** or **DOWN** buttons to position the shade at the desired “favorite” position. First press and hold the **SETTING** button on the back of the wand. While holding the **SETTING** button press and hold the **UP** button. Release both buttons when the shade beeps.

With the shade at either the upper or lower limit, simply press the **STOP/FAVORITE** button to bring the shade to the “favorite” position. To go to the “favorite” position from any other location, make sure the shade has been stopped for at least three seconds before pressing the **STOP/FAVORITE** button.

### CHANGING A FAVORITE POSITION

Use the **UP** or **DOWN** buttons to position the shade at the desired “favorite” position. First press and hold the **SETTING** button on the back of the wand. While holding the **SETTING** button press and hold the **UP** button. Release both buttons when the shade beeps.

This establishes a new “favorite” position and erases the old.

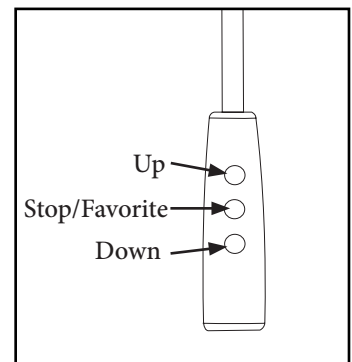
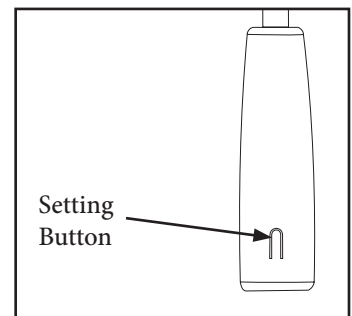

## LEVEL THE BOTTOM RAIL (IF NECESSARY)

Cellular shades use a system that allows easy leveling of the bottom rail. It is designed to make slight adjustments (less than 1") to level the bottom rail of your shade. It is not designed to make length adjustments.

Use a flat head screwdriver or a coin (a quarter works best) to turn the adjustment screw to raise or lower that side of the bottom rail. The adjustment screw is on the underside of the bottom rail.

One quarter turn of the screw will move the bottom rail up or down approximately  $\frac{1}{4}$ ".

**Over-turning the adjustment screw (more than 1" of adjustment) can cause the cord to tangle or wedge inside the rail. The screw should turn easily - DO NOT FORCE.**

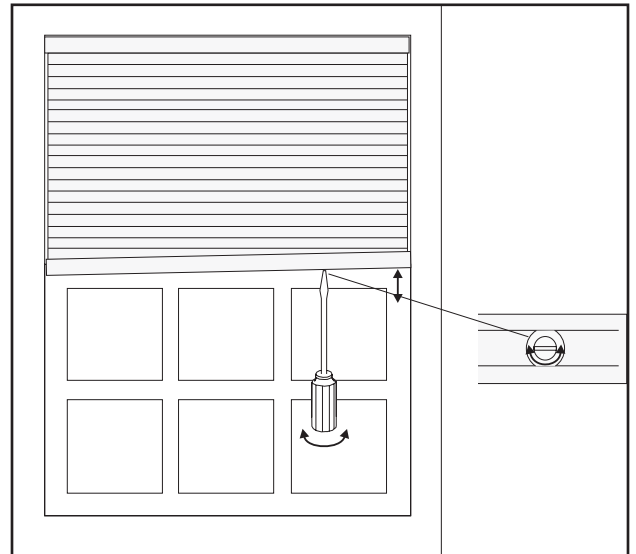

## HOLD DOWN BRACKETS (OPTIONAL)

Optional hold down brackets are mounted with the supplied screws.

With the shade at its proper drop, place the pin of each hold down into the hole in each end cap and mark the screw holes. Make sure the pins are level and aligned.

Raise the shade, then screw the hold down bracket into the mounting surface. Slightly flex the hold down brackets to insert the pins into the endcaps.

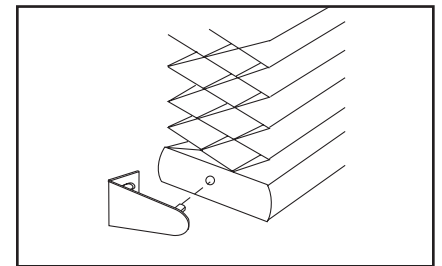

Hold Down Bracket

## CHARGING THE MOTOR BATTERY

When the shade begins to operate slower than normal, or only beeps when you attempt to operate, it is time to charge the battery.

Plug the 8.4v charger into the port on the wand.

Plug the charger into an electrical outlet.

A red light on the charger indicates that the battery is charging.

To fully charge the batteries, allow the batteries to charge for at least 1 hour after the light on the charger turns green.

A typical charge cycle can take between 4-6 hours.

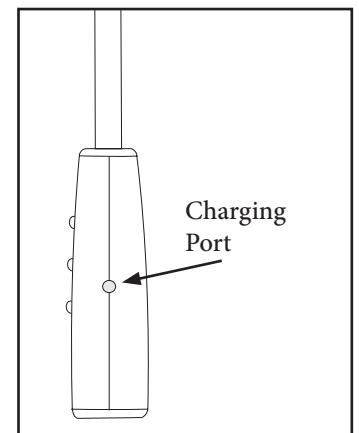

## SHADE REMOVAL

To remove a shade, insert a screwdriver between the head rail and the bottom back of the bracket (tab which extends out slightly from each bracket).

Gently pry the screwdriver to release the bracket from the head rail. Take care not to damage the painted finish of the head rail.

As you release the brackets, support the head rail to keep it from falling.

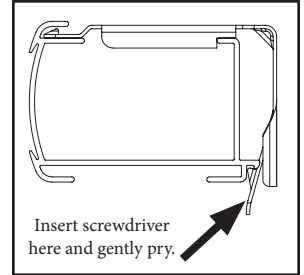

## CLEANING AND CARE

The shade fabric is easy to care for. Regular dusting with a feather duster or vacuum cleaner brush is recommended. Most stains can be blotted with a damp sponge and mild detergent. Before using anything stronger than mild detergent and lukewarm water, test an unobtrusive corner of the shade. If you have any questions, call your dealer for advice.

## TROUBLE SHOOTING

PROBLEM	SOLUTION
The motor does not work or runs slowly	Recharge battery.
The shade moves the opposite direction of the control buttons.	Press and hold the SETTING button, then press and hold the STOP button. Hold both until the motor jogs (approx. 10 seconds).



*Cellular Shades*

# MOTORIZATION

---

With Remote



---

**Installation & Care Instructions**

152735C  
7/2/2018

# GETTING STARTED

A few simple tools are required:

- Measuring tape
- Power drill, drill bits
- 1/4" Hex head and/or Phillips driver bit
- Pencil

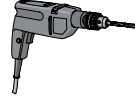

Additional fasteners other than those sent with your shade may be required depending on the mounting surface. Wallboard and plaster require the use of anchors such as expansion or toggle bolts. Brick, tile or stone need special plugs and drill bits. Remember to always pre-drill holes in wood to avoid splitting.

PN: CS4051

PN: 20201012

PN: 2930230000

PN: CS1000

PN: CS1101 (std rail)  
XCS1101 (lg. rail)

PN: CS5199

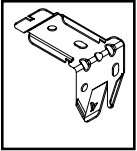

**Mounting  
Bracket**

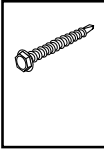

**1 1/4" Hex  
Head  
Bracket  
Screw**

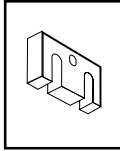

**Spacer  
Block  
(optional)**

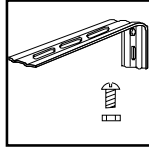

**Head Rail  
Extension and  
Side mount  
Bracket  
(optional)**

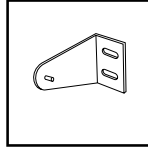

**Hold Down  
Bracket  
(optional)**

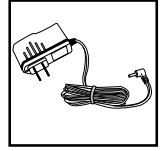

**Charger**

# STEP 1: BRACKET INSTALLATION

**Important:** If a solar recharge unit is being installed read the section on solar recharge on page 17 prior to installing mounting brackets.

Shades are shipped with the required number of brackets for proper installation. End brackets should be located approximately 3" from either end. Depending on the width of the shade, additional brackets may be necessary, evenly spaced between the two end brackets.

Shade Width	# of Brackets
Up to 40"	2
>40" - 72"	3
>72" - 84"	4
>84" and up	5

Using the installation bracket as a template, measure to the center of the bracket and mark the hole locations with a pencil for drilling.

Brackets must be in line and level. Shim brackets on inside mounts if necessary. The head rail must be level for the shade to operate properly.

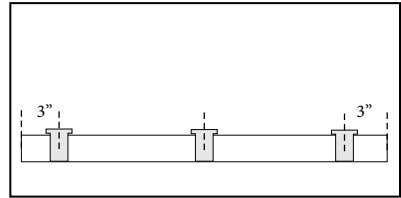
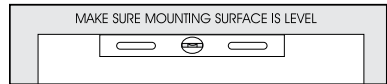

## INSIDE MOUNT

The minimum mounting depth for an inside mount is 1/2".

A minimum of 2 1/4" is needed to fully recess the shade.

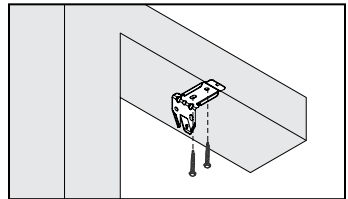

**Inside Mount**

Make sure that the brackets are level and aligned. Shallow Mount - Minimum 1/2" surface  
Flush Mount - Minimum 2 1/4" surface

Attach using two screws when possible. One screw is sufficient on shallow mounts.

## OUTSIDE MOUNT

The minimum mounting height for outside mounted shades is 7/8".

Make sure that the brackets are level and aligned.

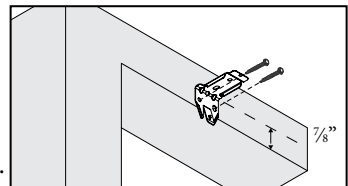

**Outside Mount**

Minimum 7/8" surface

Attach using two screws.

## SPACER BLOCKS (OPTIONAL)

Each spacer block projects brackets  $\frac{1}{2}$ " away from mounting surface.

Make sure that the brackets are level and aligned.

Attach using two screws. Screws should be long enough to secure the bracket to the mounting surface.

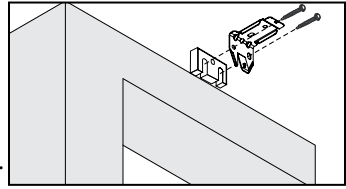

**Outside Mount with Spacer Blocks**

## EXTENSION BRACKETS (OPTIONAL)

Optional extension brackets are used to project the back of the shade up to  $2\frac{3}{8}$ " from the mounting surface.

Attach the mounting bracket to the extension bracket with the nut and bolt provided.

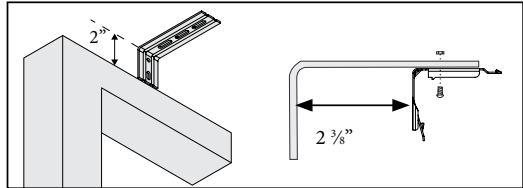

**Outside Mount with Extension Brackets**

Minimum 2" surface

## SIDE MOUNT (OPTIONAL)

Measure from window sill up to desired mounting position on each side of the window frame. Mark position.

Mount side mount brackets on each side of window frame as shown. Make sure to confirm that head rail will sit perfectly level.

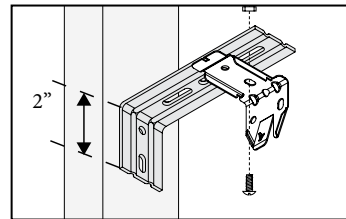

**Side Mount**

Minimum 2" surface

Once side mount brackets are installed and properly positioned, attach the mounting brackets using the nuts and bolts provided.

## STEP 2: LINK REMOTE

**Important: Please read through this section completely before beginning.**

The remote control has multiple channels. Before linking the remote, determine which shade you want on which channel. The standard remote has 5 channels, the remote with timer has 6 channels. All shades linked to a remote will also automatically be programmed to the “ALL” channel.

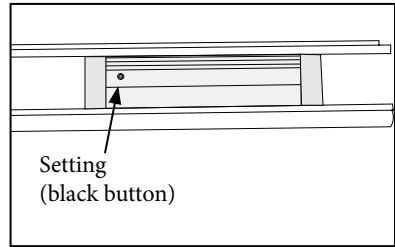

**It is recommended to only link one shade per channel** unless it is absolutely necessary to group shades other than the “all” channel. This simplifies adjusting limits and setting favorites.

Remove plastic film from the front of the remote.

If battery is not already installed in the remote follow the instructions on page 16.

**If using a timer remote, Turn the remote on using the power button on the right side of the remote. Then, tap the clock button until you see “MANUAL” in the display.**

1. Select the channel that you want to link the shade to, using the **CHANNEL** selector buttons.
2. Press the **SETTING** button on the motor until the motor starts to beep. Release the button immediately after the beeps start. The motor will make 4 fast beeps followed by 5 long beeps. Press the **CONFIRM** button on the remote anytime during the series of long beeps. It must be pressed before the last long beep. The motor will respond with 3 fast beeps confirming that the shade has been linked.
3. Repeat step 2 for all shades that will be controlled by the same channel (It is not recommended to put more than one shade on a channel).
4. Repeat steps 1-3 to link remaining shades to the rest of the channels.

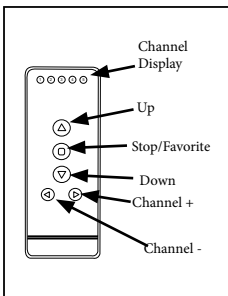

Standard Remote (front)

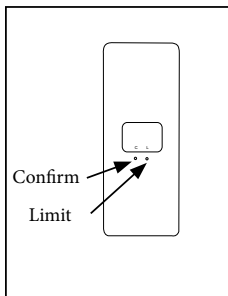

Standard Remote (back)

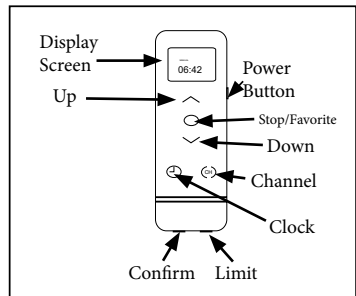

Timer Remote

## STEP 3: SHADE INSTALLATION

Before mounting the head rail make sure that the receiver wire is out of the head rail. For optimal performance, position the receiver wire so that it is facing into the room.

Position the head rail with the front lip (A) resting on the top hooks of all the brackets.

While holding the fabric out of the way, push the bottom of the head rail upward and toward the window until the groove at the bottom of the head rail snaps into place, (B) as shown.

Make sure that no fabric or the recharge plug are pinched between the brackets and the head rail.

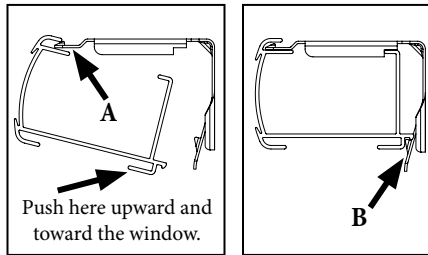

# OPERATION

## STANDARD REMOTE

Select the desired channel with the **CHANNEL** buttons. The channel indicator light will illuminate the channel that is on. If all 5 lights are lit, the remote will control all 5 channels at once.

Tapping the **UP** or **DOWN** buttons for less than 2 seconds will move the shade in short steps. Holding the **UP** or **DOWN** buttons down for more than 2 seconds before releasing will operate the shade in the faster standard speed.

Press the **UP** or **DOWN** buttons to raise or lower the shade.

Press the **STOP** button to stop the shade anywhere along the travel.

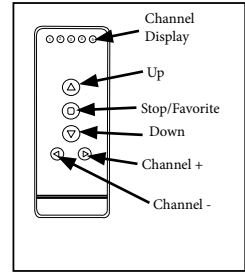

Standard Remote (front)

## TIMER REMOTE

Shades can be manually operated while in manual mode. Tap the clock button until you see “MANUAL” in the display.

Select the desired channel with the **CHANNEL** buttons. The channel will show in the display screen. If all 6 channel numbers are shown, the remote will control all 6 channels at once.

Press the **UP** or **DOWN** buttons to raise or lower the shade.

Press the **STOP** button to stop the shade anywhere along the travel.

Note: The timer remote does not have fine adjustment capability.

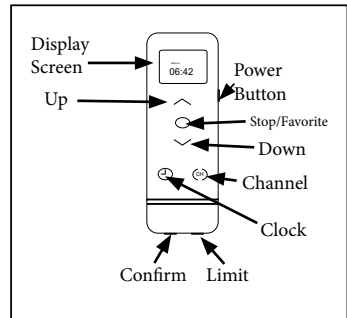

Timer Remote



Timer Remote Display Screen

## ADJUST MOTOR LIMITS (IF DESIRED)

If using a timer remote, tap the clock button until you see “MANUAL” in the display.

The lower and upper limits have been set at the factory. If you need to make adjustments to the limits, follow the instructions below.

Please Note: When clearing the factory set limits, both the upper and lower limits will need to be reset.

Use the **CHANNEL** buttons to select the channel for the shade that needs to be adjusted.

If there is only a single shade on the channel, proceed to setting limits on the next page.

If there is more than one shade on the channel, all shades will need to be unlinked. Press and hold the **CONFIRM** button. The shade will give a series of fast beeps (4 beeps/pause/4 beeps/pause/8 beeps)

When the series of beeps is complete release the **CONFIRM** button.

All shades previously linked to selected channel will now be unlinked.

Follow the steps in STEP 2: LINK REMOTE found on page 4 to link only the shade that needs to be adjusted.

Follow the limit setting instructions on next page and then relink “turned off” shades by following the steps in STEP 2: LINK REMOTE found on page 4.

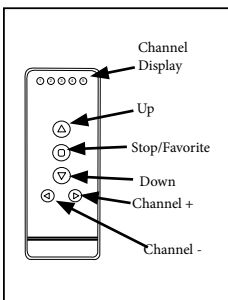

Standard Remote (front)

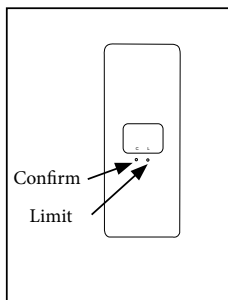

Standard Remote (back)

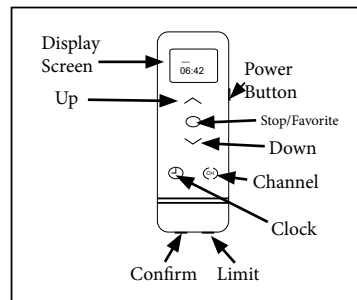

Timer Remote



## LOWER LIMIT

Hold the **LIMIT** button until the shade starts beeping.

After the shade stops beeping, use the **DOWN** button to lower the shade. Press stop when the shade is near the desired lower limit.

Use the **UP** and **DOWN** buttons to adjust the length more accurately.

Hold the **CONFIRM** button until the shade makes a series of short beeps. This locks in the lower limit.

## UPPER LIMIT

Use the **UP** button to raise the shade. Press stop when the shade is near the desired upper limit.

Use the **UP** and **DOWN** buttons to adjust the upper limit more accurately.

Hold the **CONFIRM** button until the shade makes a series of short beeps. This locks in the upper limit.

**Note:** If you also desire to set a favorite position you should do so prior to relinking other shades on that channel. See the next page for setting favorites.

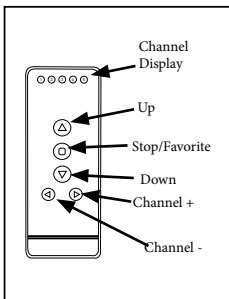

Standard Remote (front)

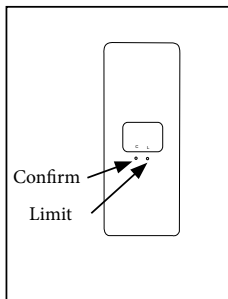

Standard Remote (back)

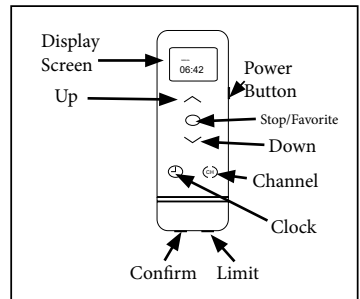

Timer Remote

## FAVORITE POSITION

If there is only a single shade on the channel proceed to setting favorites below.

If there is more than one shade on the channel, all shades on that channel will need to be unlinked.

To Unlink: Press and hold the **CONFIRM** button. The shade will give a series of fast beeps (4 beeps/pause/4 beeps/pause/8 beeps)

When the series of beeps is complete release the **CONFIRM** button.

All shades previously linked to selected channel will now be unlinked.

Following the steps in step 2 LINK REMOTE found on page 4 to link only the shade that you are setting a favorite.

Follow the favorite setting instructions below and then relink “turned off” shades by following the steps in step 2 LINK REMOTE found on page 4.

## SETTING A FAVORITE POSITION

Use the **UP** or **DOWN** buttons to position the shade at the desired “favorite” position. While holding the **LIMIT** button, quickly press and hold the **UP** button. Release both buttons when the shade makes a series of short beeps.

When complete, relink “turned off” shades by following the steps in section 2 LINK REMOTE found on page 4.

## USING A FAVORITE POSITION

With the shade at either the upper or lower limit, simply press the **STOP/FAVORITE** button to bring the shade to the “favorite” position. To go to the “favorite” position from any other location, make sure the shade has been stopped for at least three seconds before pressing the **STOP/FAVORITE** button.

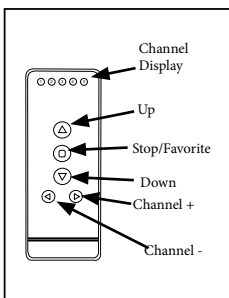

Standard Remote (front)

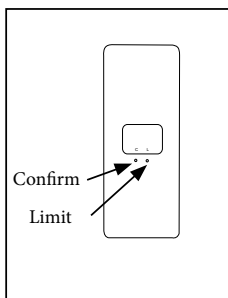

Standard Remote (back)

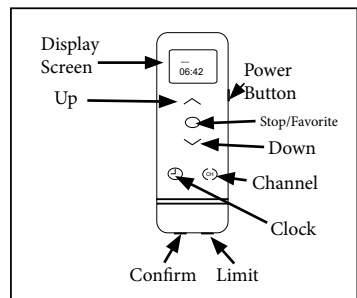

Timer Remote

# ADVANCED PROGRAMMING

## REPLACE ORIGINAL REMOTE, ADD ADDITIONAL REMOTE OR ADD SHADE TO AN ADDITIONAL CHANNEL

1. Select the channel that you want to program using the **CHANNEL** selector button.

2. Press the **SETTING** button on the motor until the motor starts to beep. Release the button immediately after the beeps start. The motor will make 4 fast beeps followed by 5 long beeps. Press the **CONFIRM** button on the remote anytime during the series of long beeps. It must be pressed before the last long beep. The motor will respond with 3 fast beeps confirming that the shade has been linked.

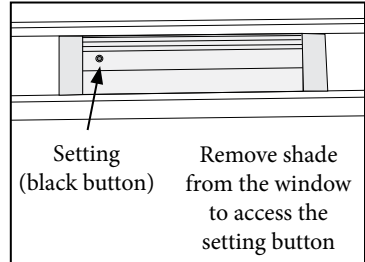

3. Repeat steps 1-2 to program the rest of the channels on a multi-channel remote. **(It is recommended to only link one shade per channel unless it is absolutely necessary to group shades other than the “all” channel. This simplifies adjusting limits and setting favorites.)**

4. All shades linked to a remote will also automatically be programmed to the “ALL” channel.

## REMOVE A SHADE FROM A REMOTE OR CHANNEL AND LINK IT TO A DIFFERENT REMOTE OR CHANNEL

1. Select the channel that you want to unlink using the **CHANNEL** selector button.

Press and hold the **CONFIRM** button. The shade(s) will give a series of fast beeps (4 beeps/pause/4 beeps/pause/8 beeps)

When the series of beeps is complete release the **CONFIRM** button.

### Link the motor to the new remote or channel

1. Follow the steps for replacing the remote above.

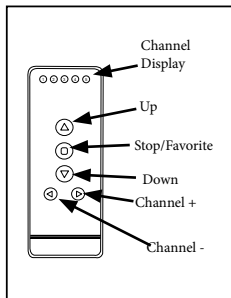

Standard Remote (front)

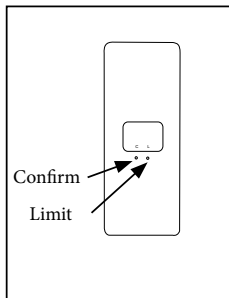

Standard Remote (back)

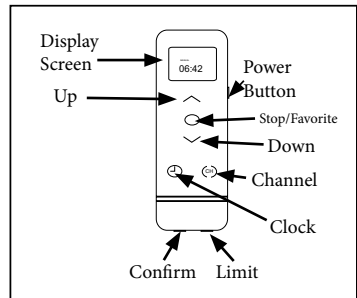

Timer Remote

# PROGRAMMING TIMER REMOTE

## SETTING CLOCK

Use the power button to turn on the remote.

Tap the **CLOCK** button until you see “MANUAL” in the display.

Push and hold the **LIMIT** button. While holding the **LIMIT** button, push the **CLOCK** button for 3 seconds and release. The hour digits will flash.

Use the **UP** and **DOWN** buttons to set the current hour. **NOTE:** Time is in 24 hour format (military time). For example: 1:00 PM will be displayed as 13:00.

Press **CHANNEL** button to confirm hour and advance to minutes.

Use the **UP** and **DOWN** buttons to set the current minute.

Press **CHANNEL** button to confirm minute and advance to day.

Use the **UP** and **DOWN** buttons to set the current day.

Hold the **CLOCK** button for 3 seconds. Display will flash and then display the current time and day.

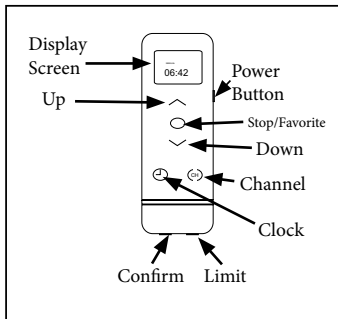

**Timer Remote**

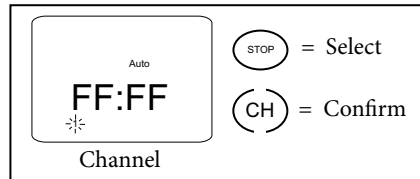

## SETTING TIMER SCHEDULES

The timer remote allows up to 18 different timer schedules. Each timer schedule can be set for multiple channels and days, but only one function can happen at each time.

Use the power button to turn on the remote.

Tap the **CLOCK** button until you see “AUTO” in the display.

While holding the **LIMIT** button, push the **CLOCK** button for 3 seconds and release. The time will flash, then display “NO 1” and the flash “FF:FF”. If you want to set a different timer schedule press **CLOCK** for 1 second to scroll through the schedules (NO 1, NO 2, NO 3 etc.). Unprogrammed schedules will display FF:FF.

Press **STOP** button and the channel number display along the bottom of the screen will flash.

Use the **STOP** button to select the channel and move on to the next one. Use the **UP** arrow to skip a channel and the **DOWN** arrow to back up. You must press **STOP** for each channel that you want to select. If the channel is still flashing, it has not been selected.

Press **CHANNEL** button to confirm channels and advance to day selection.

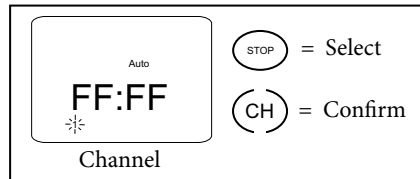
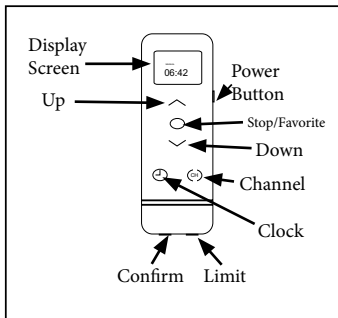

Use the **STOP** button to select the day and move on to the next one. Use the **UP** arrow to skip a channel and the **DOWN** arrow to back up. You must press **STOP** for each day that you want to select. If the day is still flashing, it has not been selected.

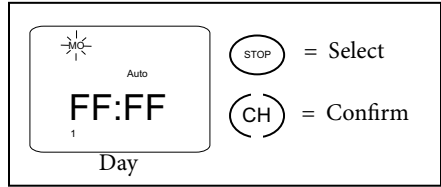

Press **CHANNEL** button to confirm days and advance to hour selection.

Use the **UP** and **DOWN** buttons to set the hour. **NOTE:** Time is in 24 hour format (military time). For example: 1:00 PM will be displayed as 13:00.

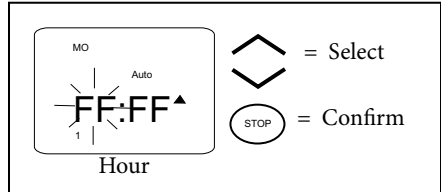

Press **STOP** button to confirm hour and advance to minutes.

Use the **UP** and **DOWN** buttons to set the minutes.

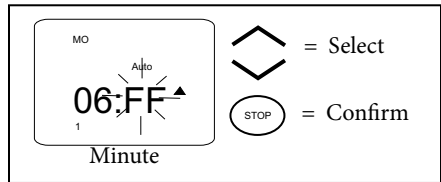

Press **STOP** button to confirm minutes and advance to shade operation.

Shade operation symbols are to the right of the time. Use the **UP** and **DOWN** buttons to select the operation. ▲ will raise the shade, ▼ will lower the shade, ◆ will bring the shade to the favorite position.

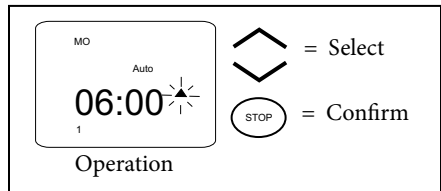

Press **STOP** button to confirm operation.

Push the **CLOCK** button for 3 seconds and release. The display will flash to confirm settings are saved and advance to the next schedule. Repeat the steps above for each desired schedule.

**When finished turn the power off to exit the set up mode.**

## IMPORTANT NOTES

- **Remote must be in “AUTO” mode for the set schedules to operate.** To return to “MANUAL” mode, tap the **CLOCK** button.
- When remote is in Auto mode, the display will alternate between the current time/day and the time/day/channel for the next upcoming schedule.
- To disable a schedule, simply reset the scheduled time to FF:FF.

## SAMPLE SCHEDULE

NO 1: CH1 & CH2, MO TU WE TH FR, 6:00, ▲

NO 2: CH1 & CH2, MO TU WE TH FR, 21:00, ▼

NO 3: CH1 & CH2, SA SU, 9:00, ▲

NO 4: CH1 & CH2, SA SU, 22:00, ▼

NO 5: CH3, MO TU WE TH FR SA SU, 10:00, ▲

NO 6: CH3, MO TU WE TH FR SA SU, 21:00, ▼

## LEVEL THE BOTTOM RAIL (IF NECESSARY)

Cellular shades use a system that allows easy leveling of the bottom rail. It is designed to make slight adjustments (less than 1”) to level the bottom rail of your shade. It is not designed to make length adjustments.

Use a flat head screwdriver or a coin (a quarter works best) to turn the adjustment screw to raise or lower that side of the bottom rail. The adjustment screw is on the underside of the bottom rail.

One quarter turn of the screw will move the bottom rail up or down approximately  $\frac{1}{4}$ ”.

**Over-turning the adjustment screw (more than 1” of adjustment) can cause the cord to tangle or wedge inside the rail. The screw should turn easily - DO NOT FORCE.**

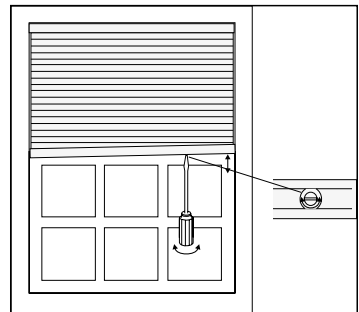

## HOLD DOWN BRACKETS (OPTIONAL)

Optional hold down brackets are mounted with the supplied screws.

With the shade at its proper drop, place the pin of each hold down into the hole in each end cap and mark the screw holes. Make sure the pins are level and aligned.

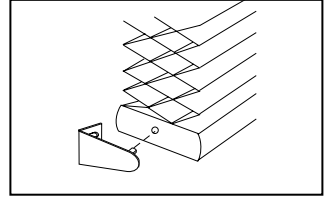

**Hold Down Bracket**

Raise the shade, then screw the hold down bracket into the mounting surface. Slightly flex the hold down brackets to insert the pins into the endcaps.

## CHARGING THE MOTOR

When the shade begins to operate slower than normal it is time to charge the motor.

Plug the 8.4v charger into the charging wire. The charging wire is attached to the back of the head rail at the left end.

Plug the charger into an electrical outlet.

A red light on the charger indicates that the battery is charging.

Allow the batteries to charge until the light on the charger turns green. A typical charge cycle can take between 4-6 hours.

Do not leave the charger plugged in for more than 24 hours. This could prematurely age the battery.

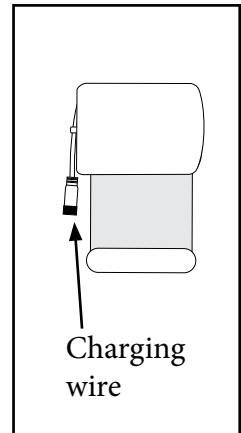



## REPLACING THE BATTERY IN THE REMOTE

### STANDARD REMOTE

Remove the battery tray from the remote by inserting a fingernail into the indentation on the back of the remote. To avoid the battery falling out of the remote, remove the tray while the remote is face up.

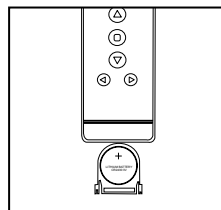

Standard Remote

Insert the new battery (CR2430 lithium) into the battery tray so that the writing is facing up (positive up) when the remote is face up. Slide the tray back into the remote.

### TIMER REMOTE

Slide the back of the remote down and then lift off the back cover.

Insert the new battery (CR2450 lithium) into the battery compartment so that the writing is facing up (positive up) when the remote is face down.

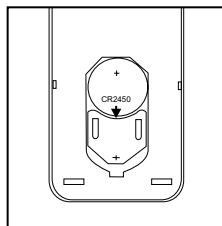
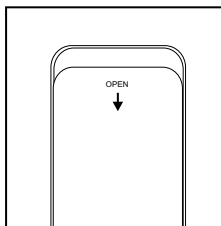

Timer Remote

Replace the back cover on the remote.

## REMOVING THE SHADE

To remove a shade, insert a screwdriver between the head rail and the bottom back of the bracket (tab which extends out slightly from each bracket).

Gently pry the screwdriver to release the bracket from the head rail. Take care not to damage the painted finish of the head rail.

As you release the brackets, support the head rail to keep it from falling.

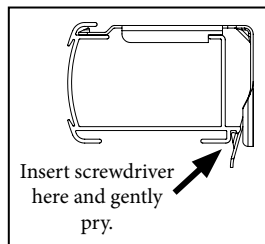

## CLEANING AND CARE

The shade fabric is easy to care for. Regular dusting with a feather duster or vacuum cleaner brush is recommended. Most stains can be blotted with a damp sponge and mild detergent. Before using anything stronger than mild detergent and lukewarm water, test an unobtrusive corner of the shade. If you have any questions, call your dealer for advice.

## TROUBLESHOOTING

PROBLEM	SOLUTION
The motor does not work	Recharge motor
The motor continues to run in one direction	The limit setting was unsuccessful and needs to be reset
The indicator light on the remote does not shine or the remote-controlling range becomes shorter	Replace the battery in the remote (CR2430 for standard remote, CR2450 for timer remote)

## SOLAR RECHARGE UNIT (OPTIONAL)

### DETERMINE SOLAR RECHARGE UNIT PLACEMENT

The solar recharge unit should be placed where it gets the maximum amount of sunlight per day. **In most cases this can be achieved by mounting the unit directly to the glass with double sided tape.**

Brackets are provided if attaching to the glass is not possible.

The brackets may be mounted several different ways depending on the application (window depth, window width, etc.).

The unit requires 19" minimum window width to mount horizontally.

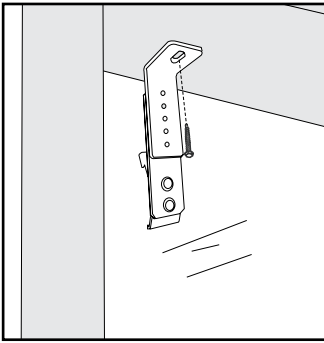

### **Inside Mount**

Bracket can be mounted behind or next to shade mounting bracket.

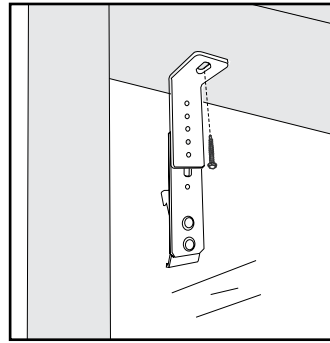

### **Inside Mount Extended**

Bottom portion of the bracket may be lowered if needed for more sun exposure.

Bracket can be mounted behind or next to shade mounting bracket.

Note: only two of the holes are threaded.

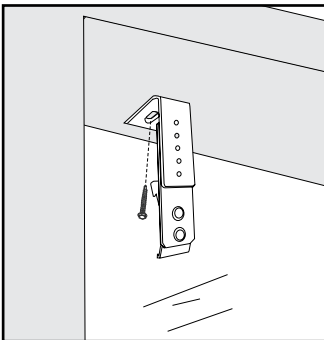

### **Inside Mount with Top Reversed**

The top portion of the bracket may be reversed if necessary depending on space.

Bracket can be mounted behind or next to shade mounting bracket.

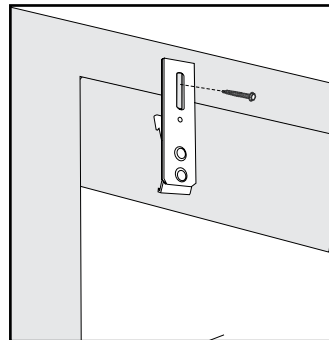

### **Outside Mount**

This method will provide the least amount of sun exposure. Bracket can be mounted next to shade mounting bracket.

# INSTALL SOLAR RECHARGE UNIT

## Tape Method

Cut the tape (part # MI051045) to fit inside the white border as shown. Clean the ends of the solar panel where the tape will go with rubbing alcohol. When dry, remove the release liner from one side of the double sided tape and adhere them to face of the panel. Make sure to put the tape on the face (black side) of the panel.

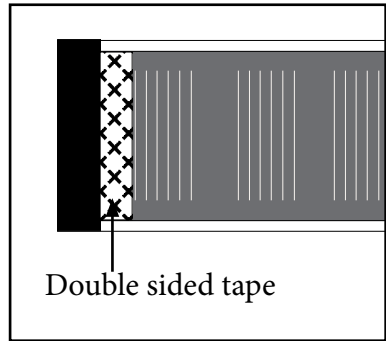

Clean the window surface with rubbing alcohol. When dry, remove the release liners and attach the solar panel to the glass, pressing firmly to adhere.

## Bracket Method

If using brackets, set the bottom groove of the unit onto the bottom bracket hook. Then press the top of the unit until it snaps into place.

If space is limited it may be easier to attach the brackets to the solar unit before screwing the brackets in place.

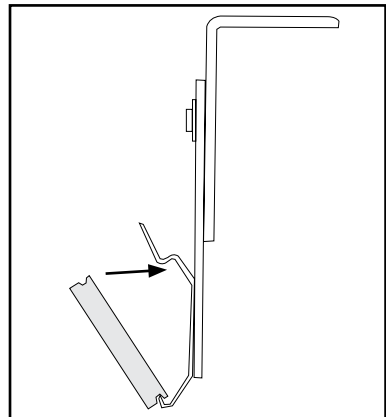

## CONNECT SOLAR RECHARGE UNIT TO MOTOR

After the shade is installed, plug the solar unit into the motor recharge port.

Use the cable ties included with the solar panel to manage excess wire.

