

# Installation Instructions

**Congratulations** on purchasing one of the best blinds on the market. You can take pride that your purchase will enhance the function and beauty of your home.

## Mounting Hardware:

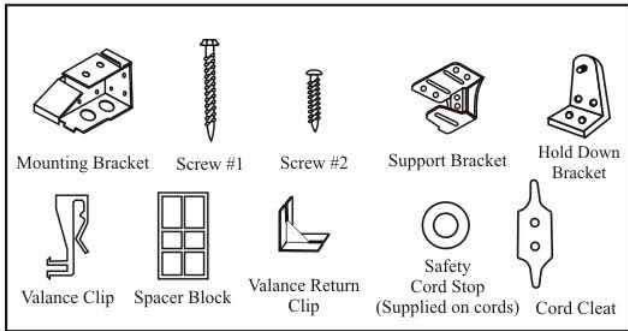

( Note : Support Bracket is supplied for blind width 36 1/8" or over)

## Tools Recommended for Installation:

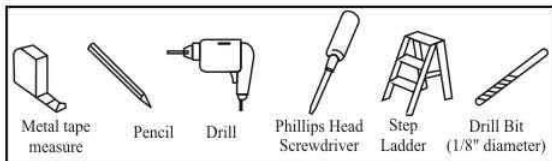

# MOUNTING INSTRUCTIONS

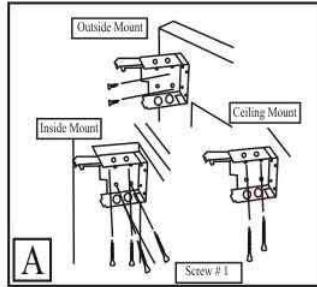

Select the method of mounting blind that best suits your purpose.

- 1) Inside window frame
  - 2) On the outside of frame
  - 3) On overhead surface i.e ceiling.
- Brackets should be placed at the end of the width of the blind's headrail 1/4" past each end.

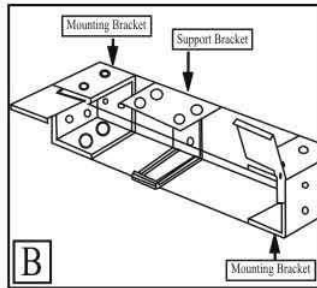

## SUPPORT BRACKET

If your blind is supplied with a support bracket, position it closer to the cord lock end of the blind. Make sure the support bracket is in line with the End Mounting Brackets.

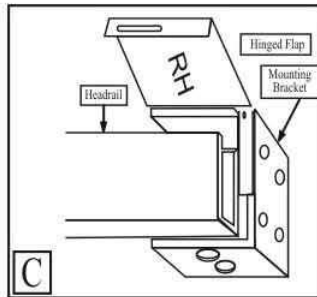

## INSERTING HEADRAIL

Insert headrail into brackets and lock hinged flaps down to hold headrail in position.

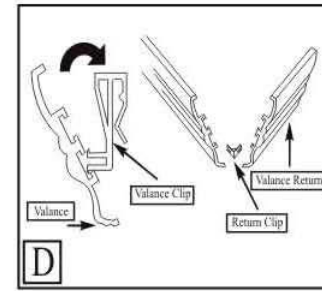

Attach valance to valance clips by snapping into rear groove of valance. Be sure valance is securely fastened before using your blind. **(This Step is recommended for inside mount window installation).** For outside mount window, simply insert the valance clips into the rear groove of valance then attaching the valance with valance clips installed onto the headrail. Insert return clip into valance return. Be sure to insert clip into mitered (angle-cut) side of valance return for proper installation. Then, attach valance return assembly to valance ends.

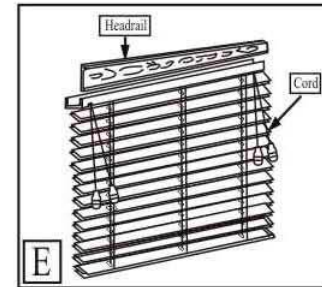

Always tilt blind horizontally before raising/lowering to extend the life of the blind. **To Lower Blind:** Move cord to left, pulling down gently until cord lock releases. **To Raise Blind:** Pull cord downward until blind reaches desired height. **To Lock cords:** pull cord right and release. Cord will lock automatically.

# WARNING

Reduce Risk of Strangulation to infants and Toddlers.  
Position Safety Cord-Stops before using Blinds.

## To Position Safety Cord-Stops:

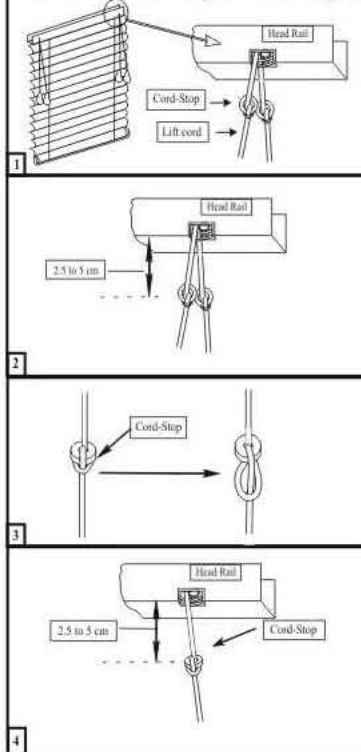

- 1 Install blind as directed by manufacturer, making sure head rail is securely fastened. Lower blind to maximum desired length and lock into place.
- 2 Measure the distance from head rail to cord stops. If cord-stops are 1" to 2" below the head rail, no further adjustment is needed. Your blinds are ready to be used.
- 3 If cord-stops ARE NOT 1" to 2" below head rail, loosen (but do not untie) the knot surrounding the cord-stop.
- 4 Push both the cord-stop and the loosened knot toward the head rail until the cord-stop is 1" to 2" below the head rail. Hold cord-stop in place and pull firmly on pull cord to re-tighten knot. Repeat steps 2, 3 & 4 for each cord-stop.

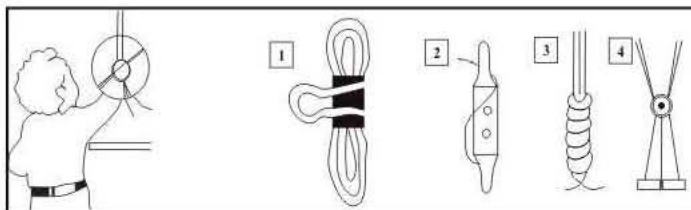

**WARNING!** Children can be strangled in blind or drapery cords. To keep cords out of reach of children, use these methods: 1. Clamp or clothes pin 3. Tie the cord to itself  
2. Cleat (supplied) 4. Tie-down device.

## Installing Spacer Blocks (optional):

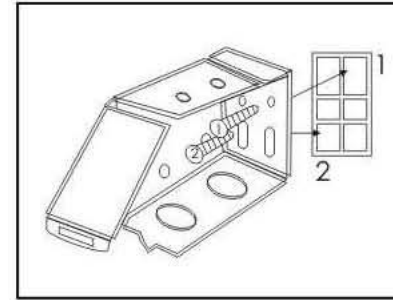

Use spacer blocks to project the standard mounting brackets out over obstructions (such as window moldings or ledges).

Align holes in back of bracket to hole in spacer block and secure to wall with screws.

## Installing Cord Cleat & Hold Down Brackets (optional):

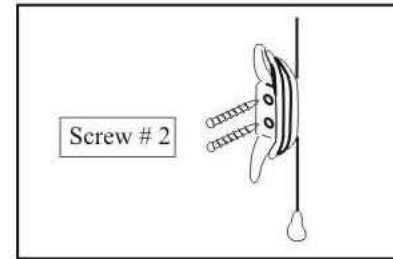

**Cord Cleat:** For added safety, install the cord cleat to the right of the blind out of reach of children.

**Please Note:** Cord must be wrapped around the cord cleat to prevent child strangulation.

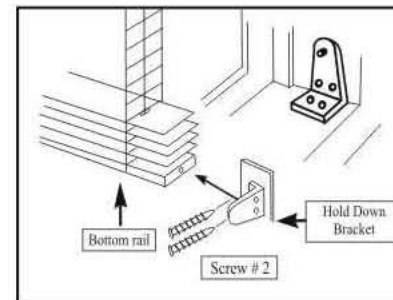

**Hold down brackets:** using two small screws, screw hold down bracket to window facing or wall. Snap bracket pin ends into the hole at bottom rail end.

**NOTE:** The use of hold down brackets is recommended but is not a requirement for the normal functioning of the blind.

N300276  
N300276-070910-DS  
420x297-大8K-70g