

MOTION CM-01/02 LI-ION TUBULAR MOTOR

Do NOT remove band around shade until installed

 **SelectBlinds®**

# Pull Wand Motorization

Li-ion battery powered tube motors  
with pull operation

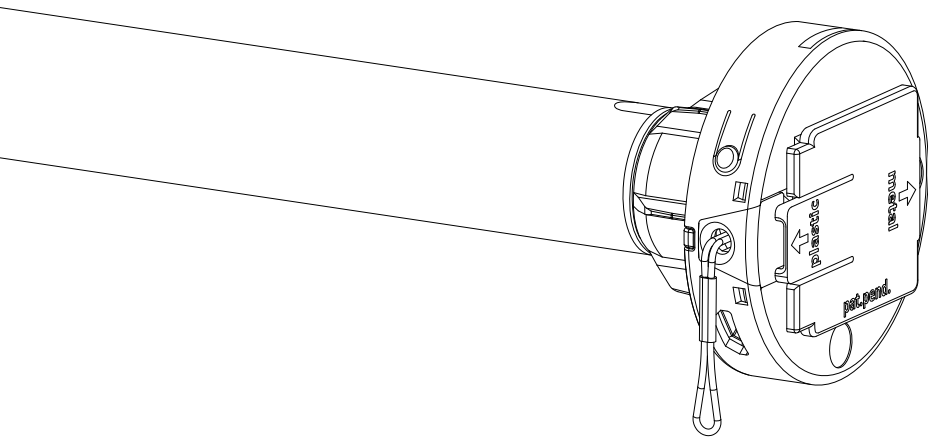

MOTION

CM-01/02  
Tube motor

Li-ion battery powered tube motors  
with pull operation



---

**Motor features**



**Li-ion Battery**  
Integrated  
lithium-ion battery



**USB Rechargeable**  
Rechargeable with  
micro USB

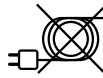

**Wireless**  
Cable free  
installation



**Happy Programming**  
Dummy proof  
programming using  
pull control



**Favourite Position**  
Preset a favourite  
position

---

**Control options**



**Pull Control**  
Operate with  
pull control

---

**Support**



**Video**  
How to install,  
program and operate  
[rtube.nl/red983](http://rtube.nl/red983)

**1** Installing the blind



**2**

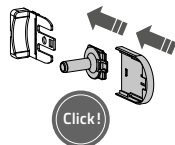

**3**

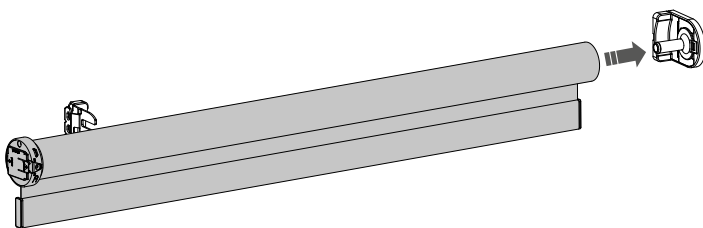

**4**

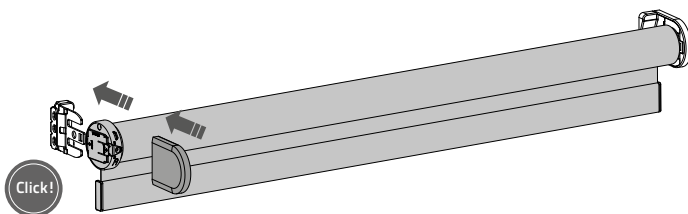

**5** Charge to activate the motor

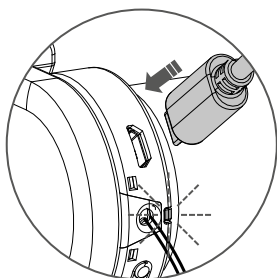

**i** Charge before first use. (See step 17)  
A green LED will flash.  
The motor can be used during charging.

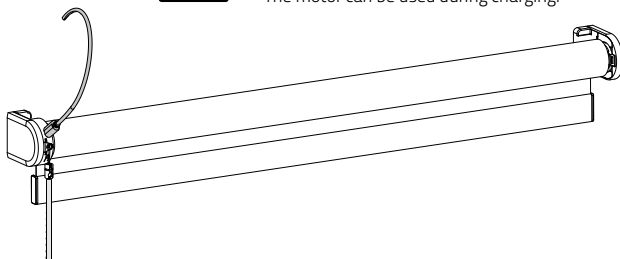

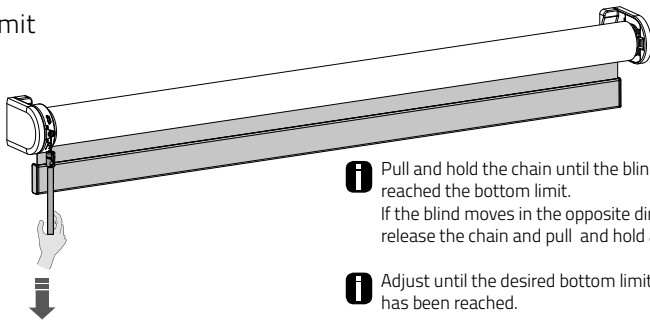
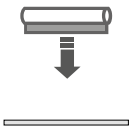
**6** Set bottom limit

- i** Pull and hold the chain until the blind has reached the bottom limit. If the blind moves in the opposite direction, release the chain and pull and hold again.
- i** Adjust until the desired bottom limit has been reached.

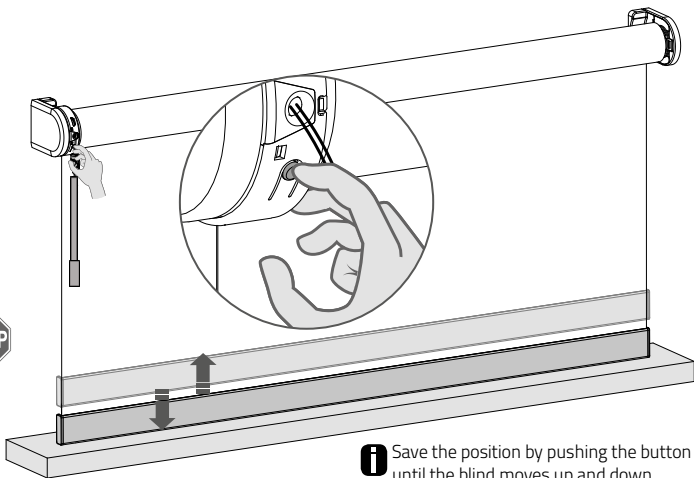
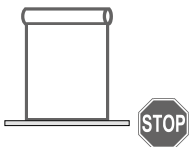
**7**

- i** Save the position by pushing the button until the blind moves up and down.

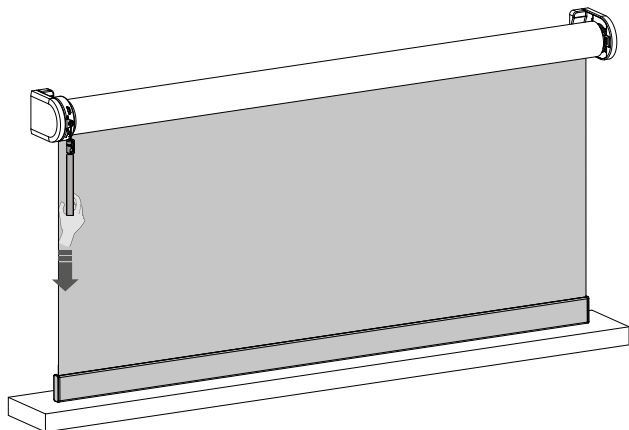
**8** Set upper limit

- i** Pull and hold the chain until the blind has reached the upper limit. If the blind moves in the opposite direction, release the chain and pull and hold again.
- i** Adjust until the desired upper limit has been reached.

9

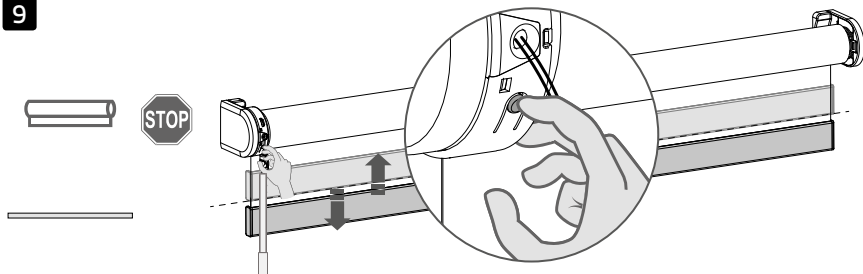

**i** Save the position by pushing the button until the blind moves up and down.

10 Operating the blind

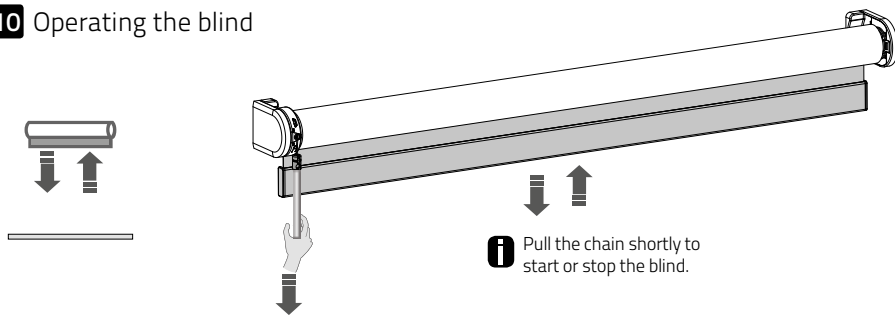

**i** Pull the chain shortly to start or stop the blind.

11 Optional: set favourite position

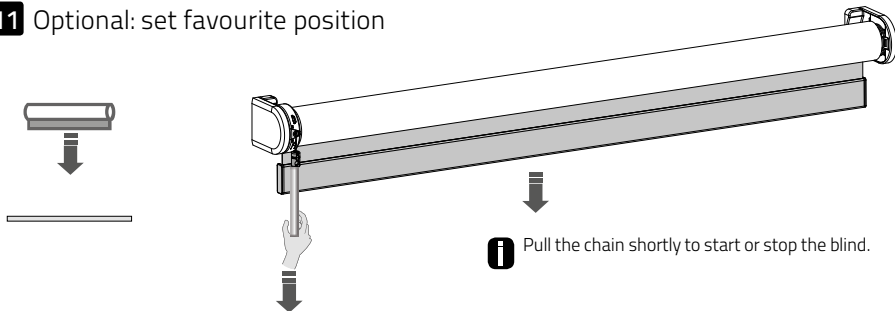

**i** Pull the chain shortly to start or stop the blind.

12

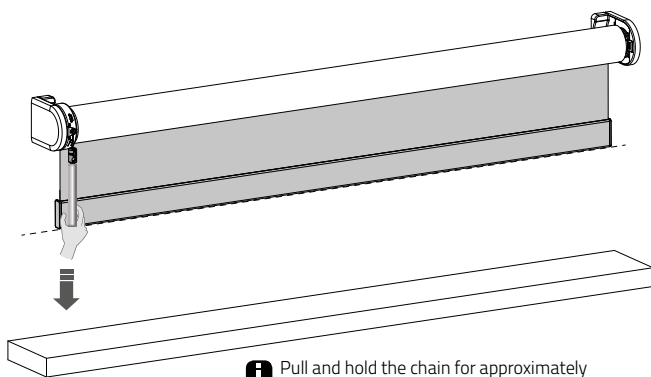
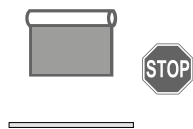

**i** Pull and hold the chain for approximately 7 seconds until the blind moves up and down.

13

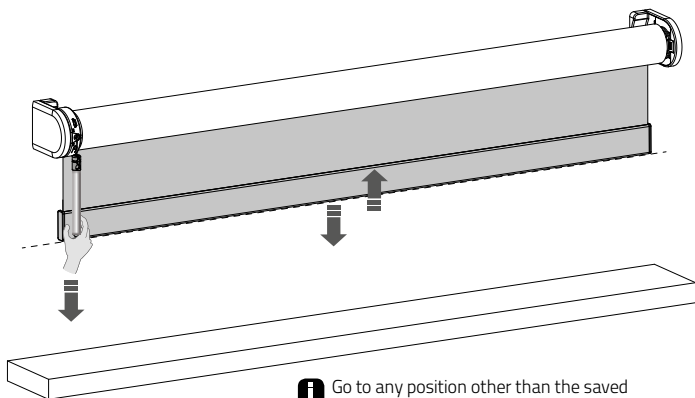
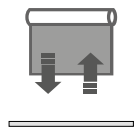

**i** Go to any position other than the saved favourite position.

14 Move to favourite position

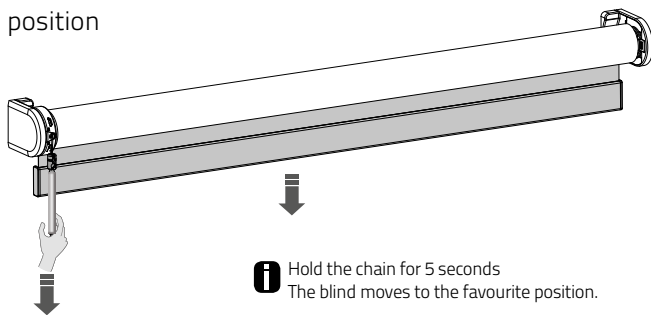
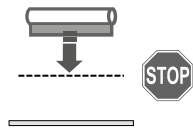

**i** Hold the chain for 5 seconds  
The blind moves to the favourite position.

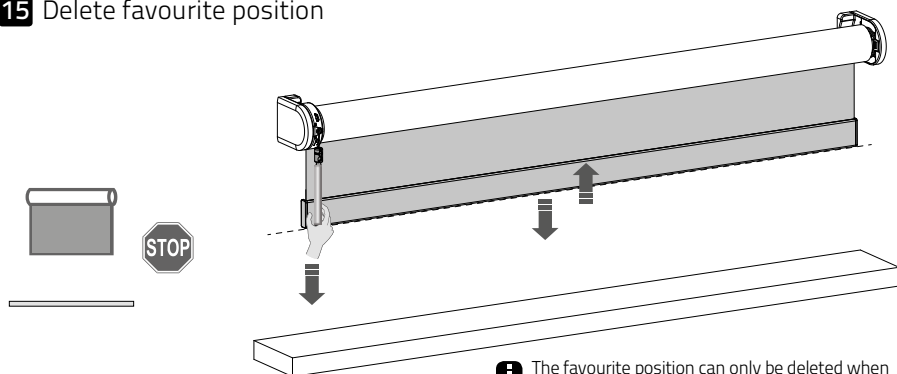
**15** Delete favourite position

- i** The favourite position can only be deleted when the blind is placed in the favourite position.
- i** Pull and hold the chain for approximately 7 seconds until the blind moves up and down.
- i** Go to step 11 to program a new favourite position.

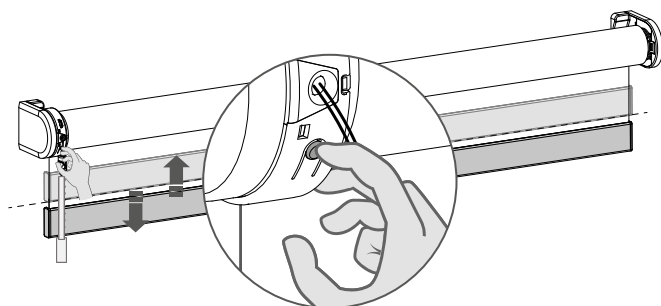
**16** Delete end limits

- i** Hold the button for approximately 10 seconds. After 5 seconds, the blind will move up and down. Keep pushing the button until the blind moves up and down again.
- i** Repeat steps 6 - 9 to save new end limits.

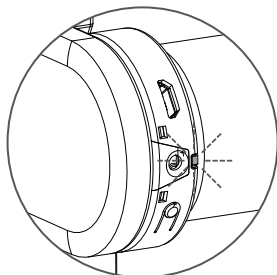
**17** Recharge battery

Blinking red during  
operation;  
Charge the battery

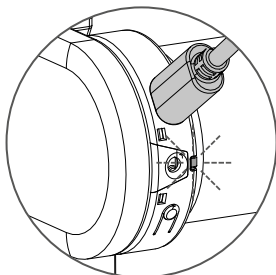

Blinking green;  
battery is charging

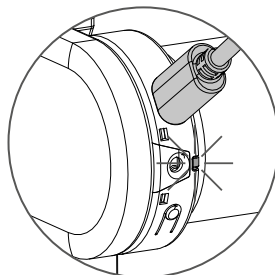

Continuously green;  
battery is fully charged

**18** Activate / deactivate the motor

**i** To prevent the blind from getting damaged, the motor has a transport mode that makes sure the blind will not be activated before installation.

**18.1** Hold the program button and pull twice to activate or deactivate the motor.  
The motor can also be activated by charging it with a micro USB cable.

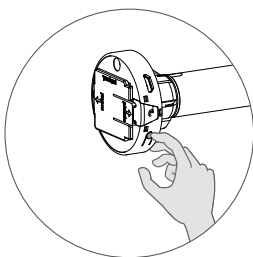

+

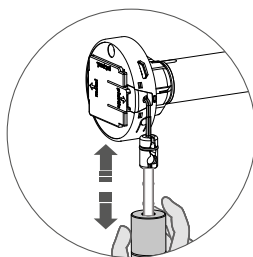

or

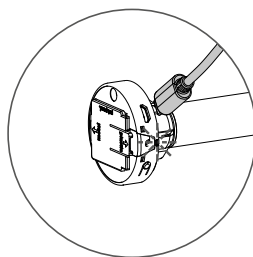



## Frequently Asked Questions

<b>Problem</b>	<b>Cause</b>	<b>Solution</b>
Motor is not responding.	Motor is in transport mode.	Activate the motor. See step 18.
	Motor battery is empty.	Charge the motor. See step 17.
Motor LED flashes red.	The battery of the motor is empty.	Charge the motor. See step 17.
Motor is not charging.	Charger is not plugged in or does not work.	Try a different charger or make sure the charger is plugged into the outlet.
Blind lowers too far.	End limits are programmed incorrectly.	Reprogram end limits. See step 6 - 9.
Unable to program end limits.	End limits have already been programmed.	Reset the motor and reprogram end limits. See step 16 and step 6-9.



# Wireless Pull Wand Motorization

Li-ion battery powered tube motors  
with pull and remote operation

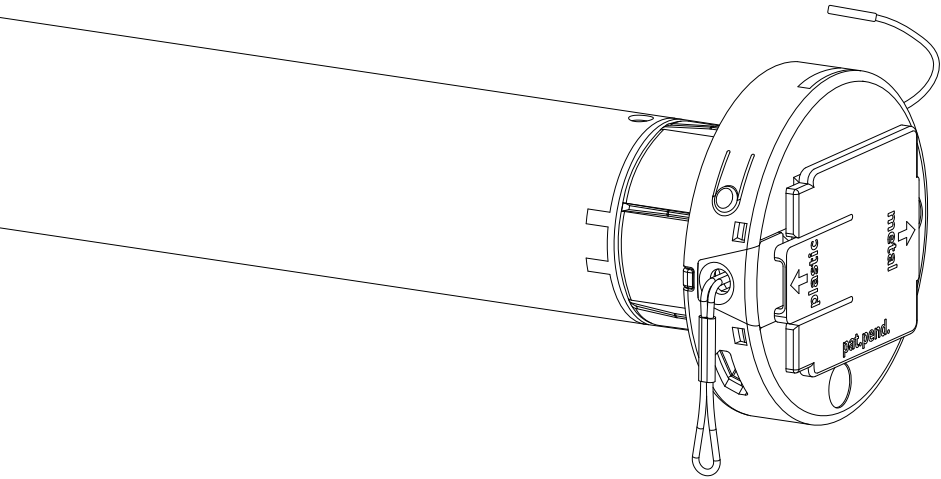

MOTION

## CM-03/05

Li-ion battery powered tube motors with  
pull and remote operation

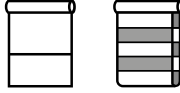

---

### Motor features



**Li-ion Battery**  
Integrated  
lithium-ion battery



**USB Rechargeable**  
Rechargeable with  
micro USB

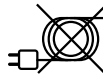

**Wireless**  
Cable free  
installation



**Speed Control**  
Consistent  
rolling speed



**Bi-directional**  
Two-way  
communication for  
real-time response

---

### Control options



**Pull Control**  
Operate with  
pull control



**Remote Control**  
Operate with a  
remote control



**App Control**  
Operate with the  
MOTION app



**Connectivity**  
Compatible with  
home and building  
automation

---

### Support



**Video**  
How to install,  
program and operate  
[rtube.nl/red980](http://rtube.nl/red980)



**App Store**  
Download the  
MOTION app  
[rtube.nl/red981](http://rtube.nl/red981)



**Google Play**  
Download the  
MOTION app  
[rtube.nl/red982](http://rtube.nl/red982)

---

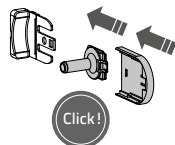
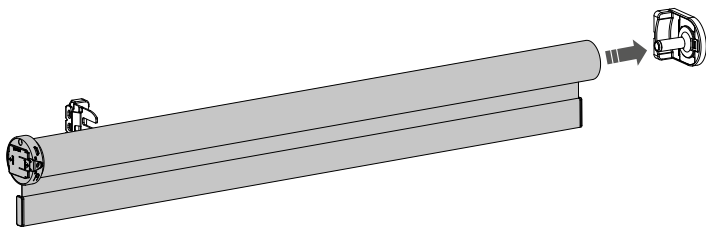
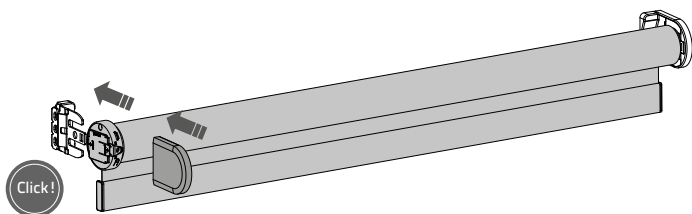
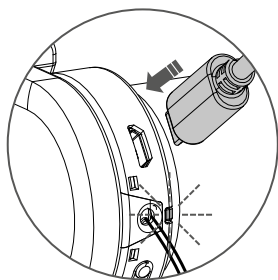
**1** Install the blind**2****3****4****5** Activate the motor

Activate the motor by charging it with a micro USB cable. A green LED will start flashing. The motor can be used during charging. (To activate the motor without a micro USB cable, see step 25)

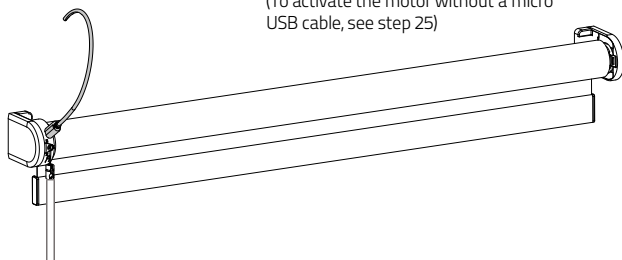

## 6 Pair a remote

- i** Pair a remote control that is able to program blinds. See pages 4 and 5 for remote control details. In this manual, CM-12 is displayed.

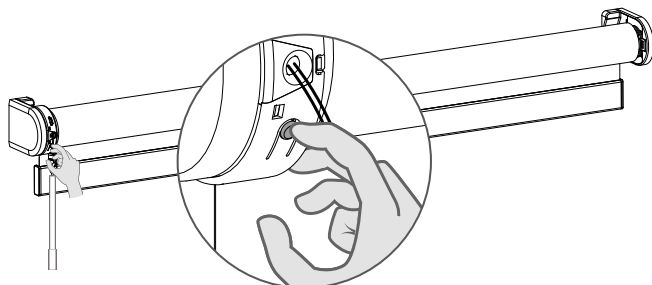

- 6.1** Shortly press the **program** button on the motor. The blind will start stepping, indicating that program mode has been activated. (The blind keeps stepping until the program mode is deactivated.)
- 6.2** Select a desired channel for the blind using the **channel selection** button on the remote control.
- 6.3** Press the **pair** button on the back of the remote control to pair the blind with the selected channel. The blind will shortly stop stepping, indicating that the remote has been paired to the blind.

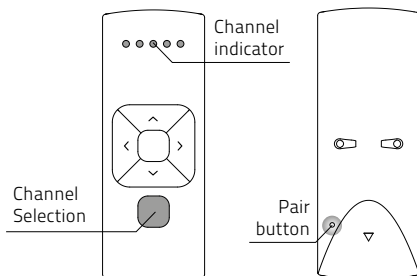

- i** Repeat steps 6.1 - 6.3 to remove a blind from a channel.

- i** End limits must be programmed to use a blind properly and to prevent it from being damaged. Proceed to step 12 if end limits are already set.

## 7 Check rotational direction



**WARNING:** risk of damage.  
Stop the blind before reaching the end positions.

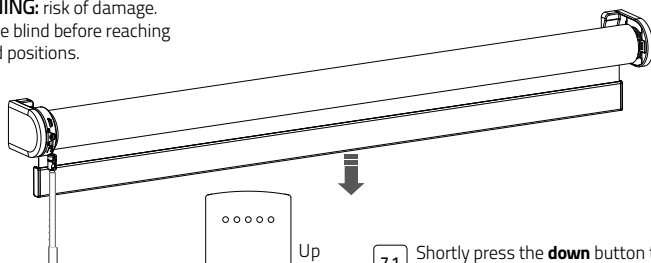

- 7.1** Shortly press the **down** button to check if the blind unrolls the right way. If the blind moves up, the rotational direction must be changed.
- 7.2** Simultaneously press the **up** and **down** button to change the rotational direction.

**8** Set bottom position

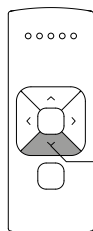
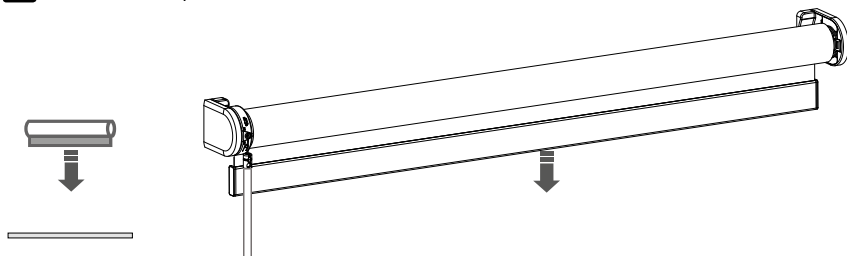

**8.1** Press and hold the **down** button until the blind reaches the desired bottom position.

**WARNING:** risk of damage.  
Slowly approach the bottom position.

**9**

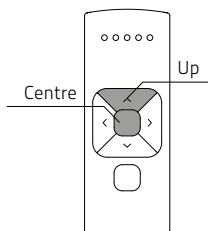
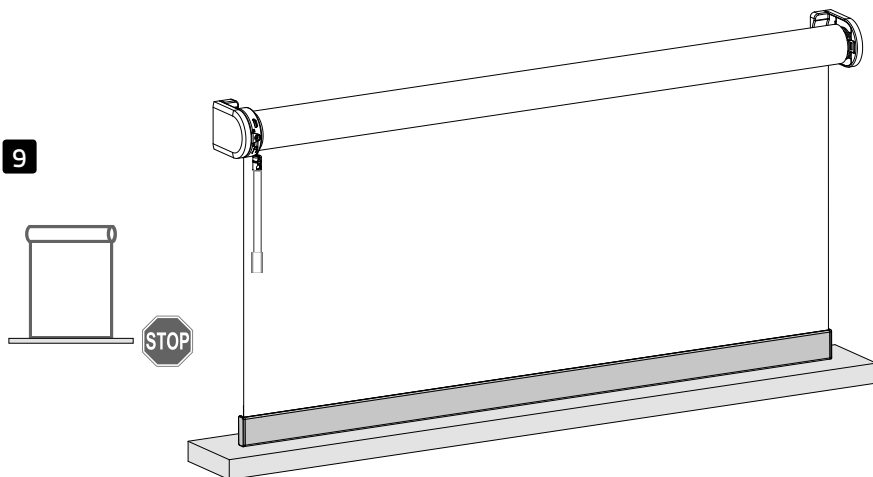

**9.1** Simultaneously hold the **centre** and the **up** button until the blind stops stepping and starts stepping again. The bottom position has been saved.

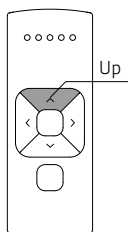
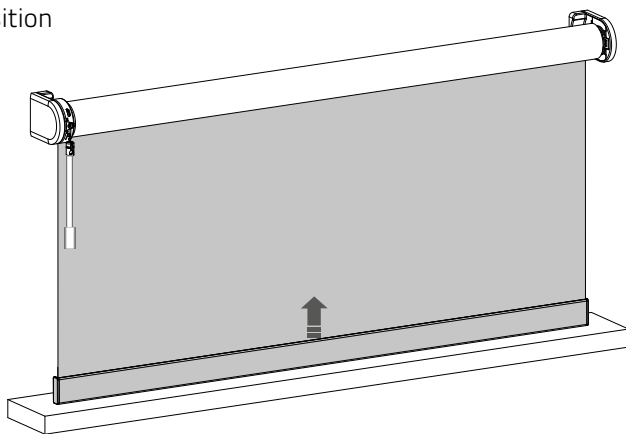
**10** Set top position

- 10.1** Press and hold the **up** button until the blind reaches the desired top position.

**WARNING:** risk of damage.  
Slowly approach the top position.

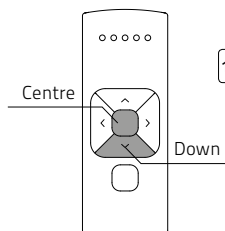
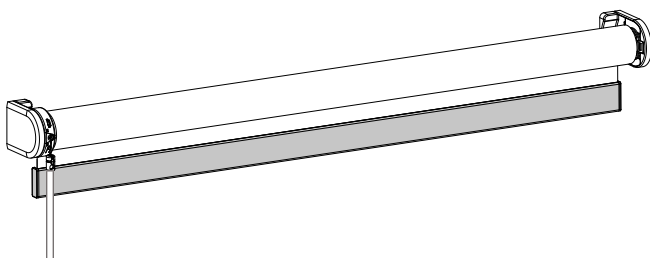
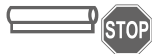
**11**

- 11.1** Simultaneously hold the **centre** and the **down** button until the blind stops stepping and starts stepping again. The top position has been saved.

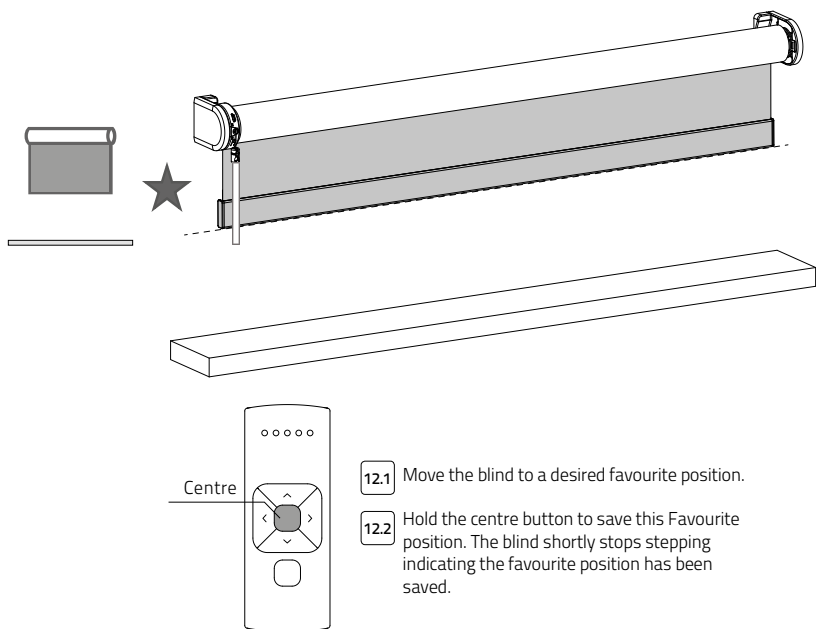
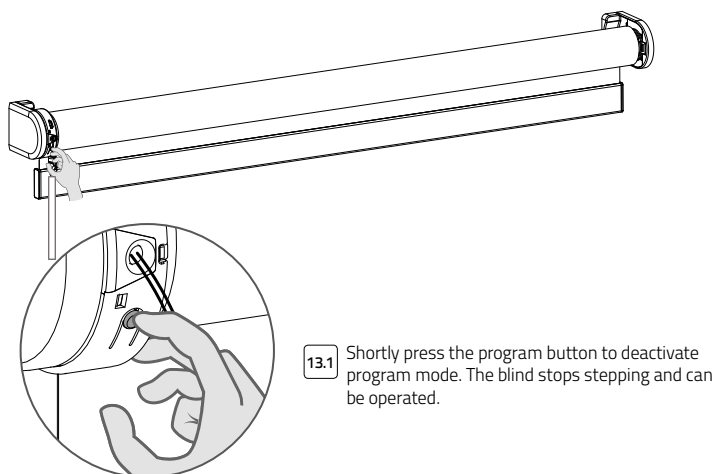
**12** Set favourite position (optional)**13** Deactivate program mode



## 14 Operate the blind

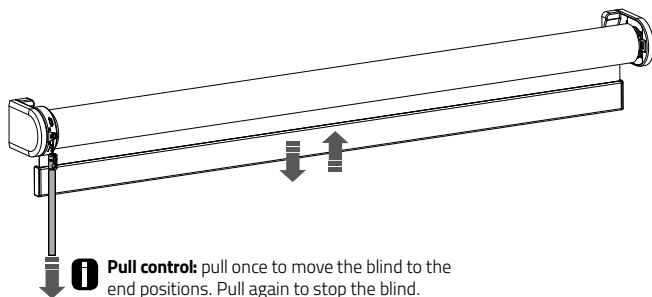
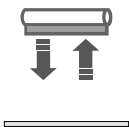

**i Pull control:** pull once to move the blind to the end positions. Pull again to stop the blind.

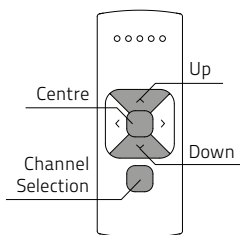

**i Remote control:** Choose the channel with which the blind has been paired using the **channel** button. Press the **up** or **down** button to operate the blind. Press the **centre** button to stop the blind.

## 15 Move to favourite position

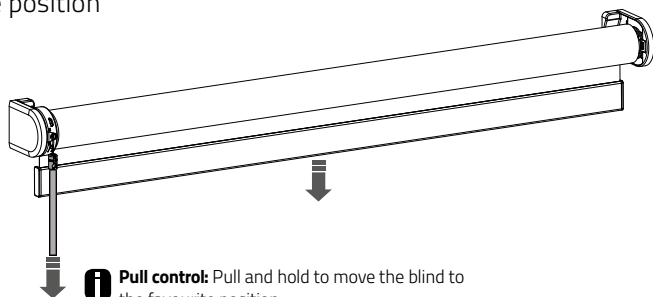
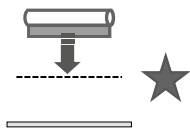

**i Pull control:** Pull and hold to move the blind to the favourite position.

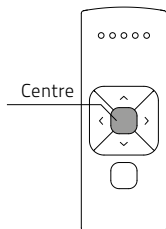

**i Remote control:** press the **centre** button to move the blind to the favourite position.

## 16 Reset favourite position

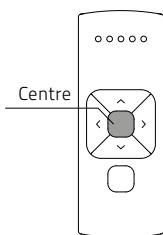
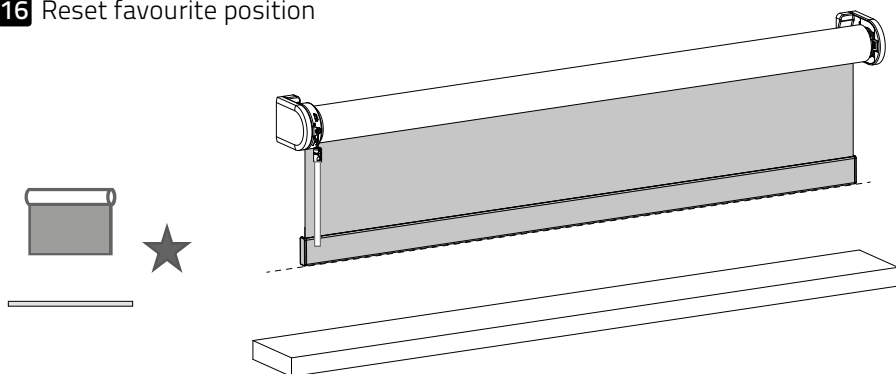

- 16.1 Move the blind to a desired favourite position.
- 16.2 Press the **program** button on the motor to activate program mode. The blind starts stepping.
- 16.3 Hold the **centre** button to save this favourite position. The blind shortly stops stepping, indicating the favourite position has been saved successfully.
- 16.4 Press the **program** button on the motor to deactivate program mode. The blind stops stepping.

## 17 Deactivate direct control

**i** When pressing the up or down button on the remote control, the blind directly moves to its end positions (direct control). To operate the blind with smaller steps using the up and down button, direct control can be deactivated. Now, the blind only directly moves to its end positions when the up or down button is held longer than two seconds.

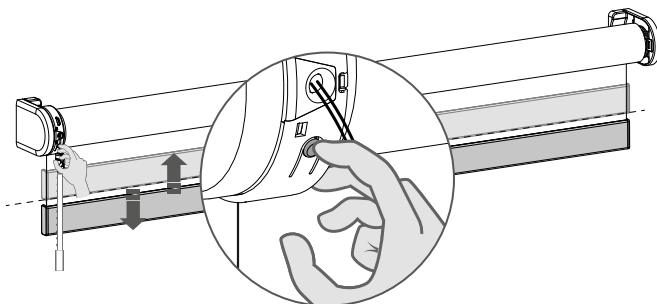

- 17.1 Press the **program** button on the motor to activate program mode. The blind starts stepping.
- 17.2 Hold the **program** button until the blind stops stepping (approximately 5 seconds) to deactivate or reactivate direct control.

**18** Reset the blind

- i** It is possible to only delete end limits or to do a factory reset.  
Factory reset will delete the end limits and remove the connection to any paired remote.

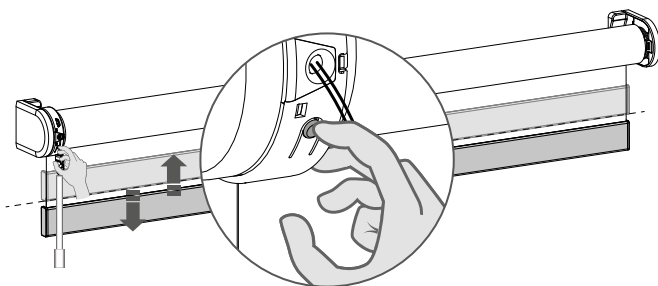

**18.1** Press the program button on the motor to activate program mode.

- i** **Delete end limits:** to delete the end limits of the blind, hold the **program** button until the blind stops stepping for the first time, and keep holding the button until the blind stops stepping for the second time. (approximately 10 seconds)
- i** **Factory reset:** to reset the blind to factory defaults hold the button for at least 20 seconds. The blind will stop stepping twice. After the second stop the blind will give one extra step to confirm factory reset.

**19** Recharge the battery

Use a micro USB cable  
to charge the motor

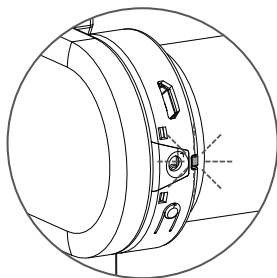

LED light flashes  
red during operation;  
Charge the battery

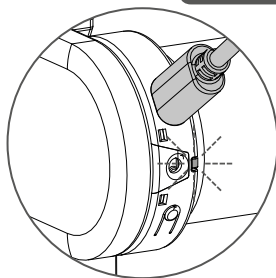

LED light flashes  
green;  
battery is charging

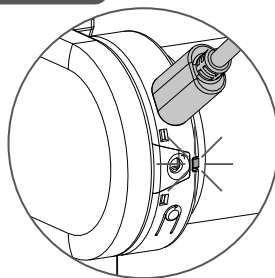

LED light constantly  
green;  
battery is fully charged

## **i** Advanced options

### **20** Manual control

**i** In case there is no remote control or pull control, the blind can be operated with the program button on the motor.

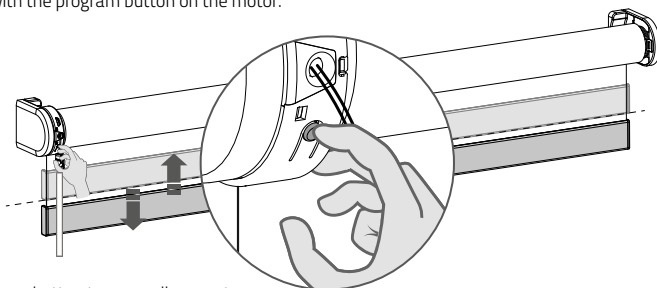

**20.1** Hold the **program** button to manually operate the blind. The blind will move as long as the button is being pressed. (max. 15 sec.)

**20.2** To move the blind in opposite direction, release the **program** button and repeat step 20.1.

### **21** Single select 5 channel remote

**i** Single select makes it possible to activate program mode on a single blind through a remote control, without having to physically press the program button on the blind.

**21.1** To activate Single select, simultaneously hold the **centre** button and press the **pair** button.

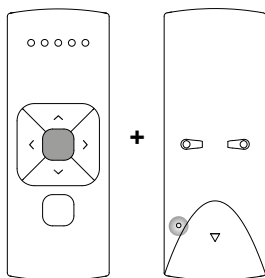

**21.2** The remote starts searching for blinds (search mode). This is indicated by the LEDs flashing from left to right.

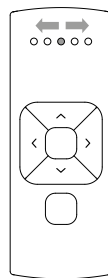

**21.3** Once a blind is found, the channel LED will flash and the blind starts stepping, indicating that program mode has been activated. The blind can now be (un)paired to the remote and/or programmed.

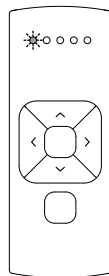

**21.4** To search for the next blind, press the **right** button. Search mode will be activated. To find the previous blind, press the left button.

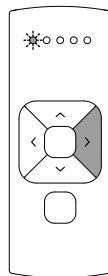

**21.5** To exit Single select, press the **right** button during search mode.

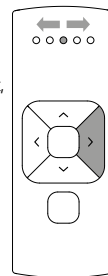

## 22 Single select 15 channel remote

**i** Single select makes it possible to activate program mode on a single blind through a remote control, without having to physically press the program button on the blind.

**22.1** To activate Single select, simultaneously hold the **centre** button and press the **pair** button.

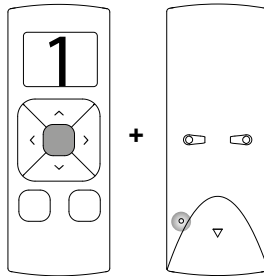

**22.2** The remote starts searching for blinds (search mode). This is indicated by the horizontal bars on the remote.

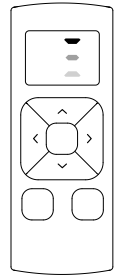

**22.3** Once a blind is found, the channel number will flash and the blind starts stepping, indicating that program mode has been activated. The blind can now be (un)paired to the remote and/or programmed.

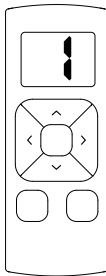

**22.4** To search for the next blind, press the **right** button. Search mode will be activated. To find the previous blind, press the left button.

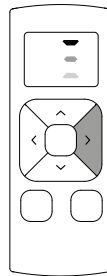

**22.5** To exit Single select, press the **right** button during search mode. The display shows the letter **O**.

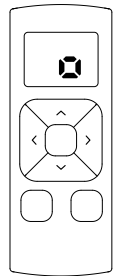

## 23 Channel select 5 channel remote

**i** Channel select makes it possible to copy blinds in between channels/remotes without having to physically press the program button on the motors.

**23.1** Select the channel from which the blinds must be copied.

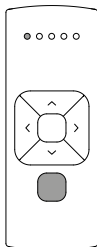

**23.2** To activate channel select, simultaneously hold the **channel selection** button and press the **pair** button.

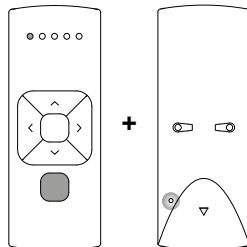

**23.3** All blinds in the selected channel will start stepping, indicating program mode has been activated. All blinds can be copied to a new channel on the same remote or a different remote. Select a new channel on the (new) remote.

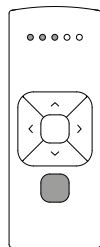

**23.4** Press the pair button on the (new) remote to pair the blinds with the new channel.

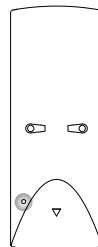

**23.5** To exit channel select, go back to the channel selected at step 23.1 and repeat step 23.2

## 24 Channel select 15 channel remote

**i** Channel select makes it possible to copy blinds in between channels/remotes without having to physically press the program button on the motors.

**24.1** Select the channel you would like to copy.

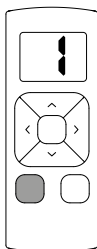

**24.2** To activate channel select, simultaneously hold the **channel selection** button and press the **pair** button.

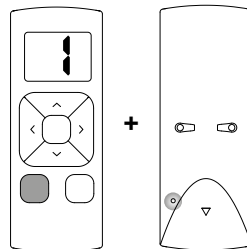

**24.3** All blinds in the selected channel will start stepping, indicating program mode has been activated. All blinds can be copied to a new channel on the same remote or to different remotes. Select a channel on a (new) remote.

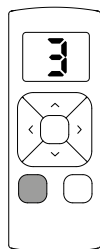

**24.4** Press program button on the (new) remote to pair the blinds with the (new) remote.

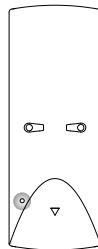

**24.5** To exit channel select, choose the channel you selected at step 24.1 and repeat step 24.2

**25** Activate / deactivate the motor

**i** To prevent the blind from getting damaged, the motor has a transport mode that makes sure the blind will not be activated before installation.

**25.1** Hold the program button and pull twice to activate or deactivate the motor.  
The motor can also be activated by charging it with a micro USB cable.

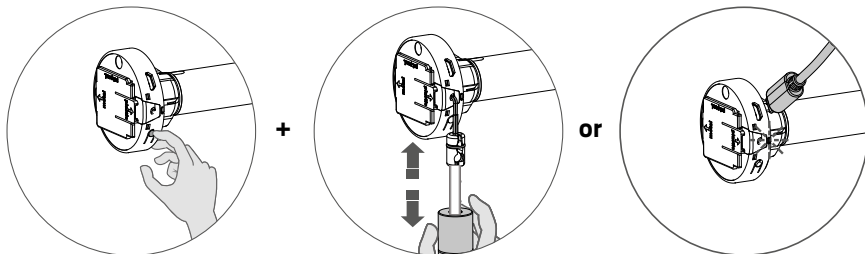

## Frequently Asked Questions

Problem	Cause	Solution
Blind does not work.	Motor is in transport mode.	Activate the motor. See step 25.
	Motor battery is empty.	Charge the motor. See step 19.
	Remote battery is empty. (LEDS of remote are flashing rapidly.)	Replace the battery in the remote. See the manual of the remote.
	Remote battery is inserted incorrectly.	Replace the battery in the remote. See the manual of the remote.
	Radio-frequency interference	Make sure that the antenna of the motor is out of the way of metal objects.
	The distance from the remote to the motor is too far.	Move closer to the motor.
	The remote is not connected to the blind.	Pair the remote with the motor. See step 6.
Motor LED flashes red.	The battery of the motor is empty.	Charge the motor. See step 19.
Blind is not charging.	Charger is not plugged in or does not work.	Try a different charger or make sure the charger is plugged in the outlet.
Multiple blinds respond to a remote. (Unable to program a single blind)	Multiple blinds are paired with a single channel.	Pair the blind with a free channel to program or use single select to program the blind.
Blind moves in small steps.	1) No end limits are programmed. 2) Direct control is deactivated.	1) Program end limits. See step 8 - 11. 2) Activate direct control. See step 17.
Favourite position can not be programmed.	No end limits are programmed.	Program end limits. See step 8 - 11.
Blind lowers too far.	End limits are programmed incorrectly.	Reprogram end limits. See step 8 - 11.
Blind moves in the opposite direction.	The rotational direction has been set incorrectly.	Change the rotational direction. See step 7.
The blind keeps moving up and down.	The blind is in program mode.	Press the program button on the motor to exit program mode.

Select Blinds motors powered by Eve MotionBlinds works with Apple HomeKit technology.

# SETUP GUIDE

## ROLLER SHADE

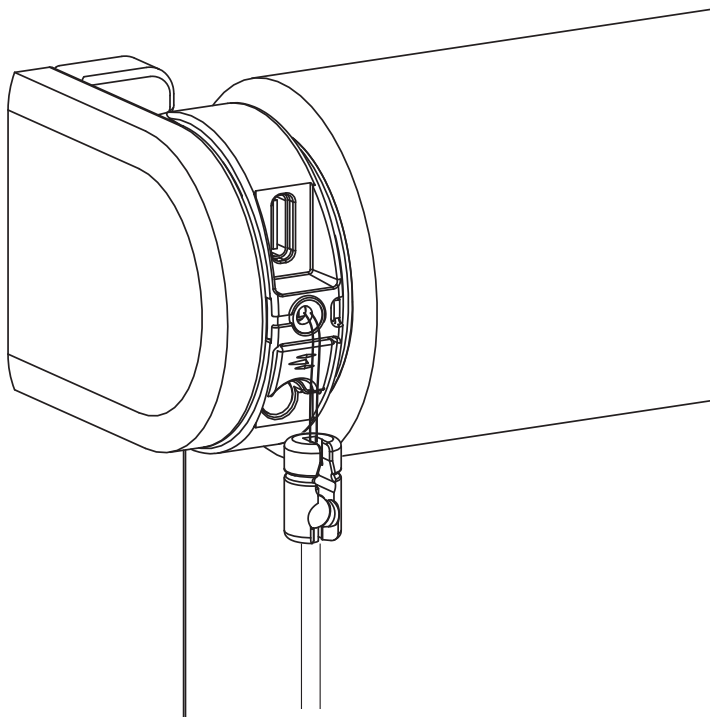



**i** Buttons and functions

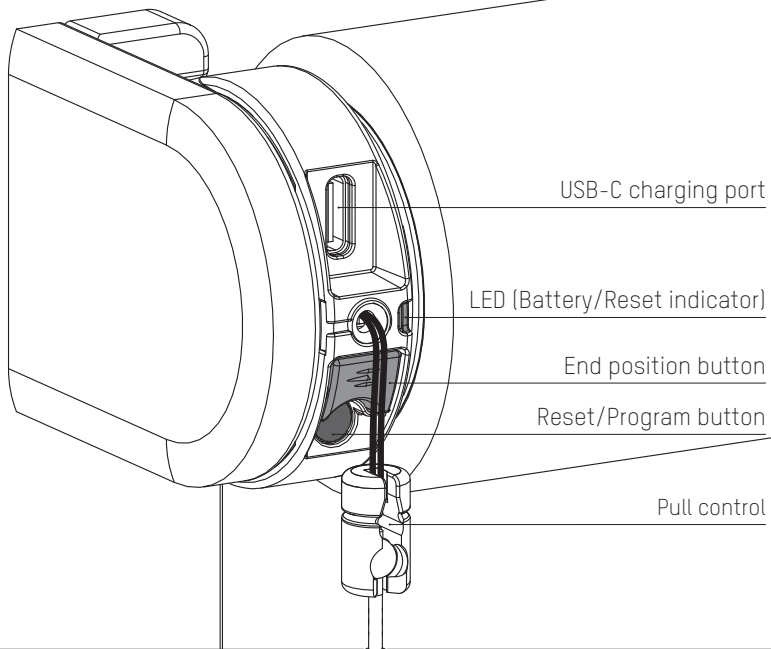

## 1 Install

Follow the steps in the installation instructions to install shade.

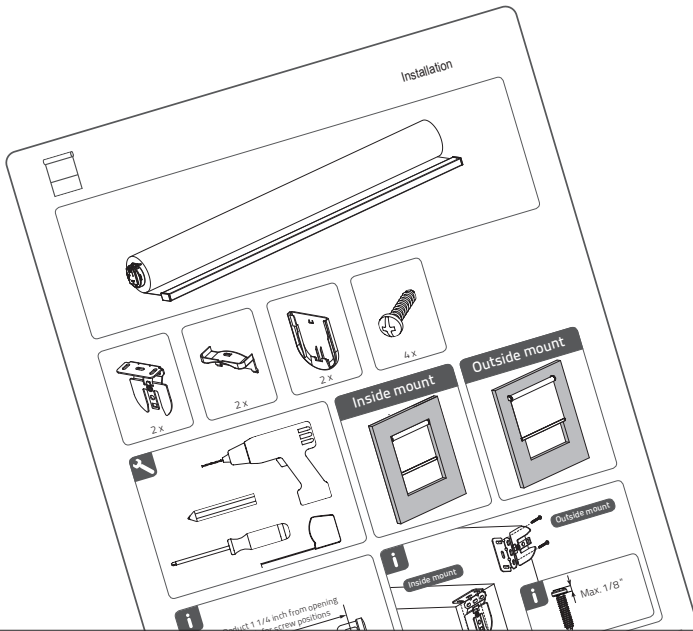

## 2 Activate

To activate the shade, connect it to a standard USB-C 5V power supply via a USB-C cable. This can be your iPhone's power adapter, for example.

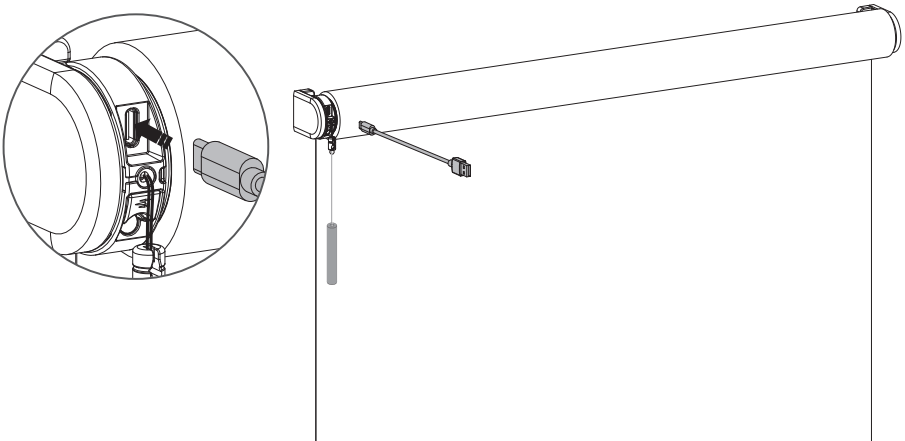

### 3 Download the Eve app

Download the Eve app from the App Store.

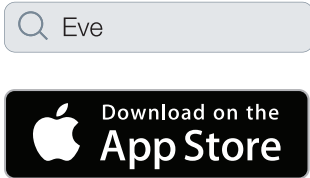

### 4 Setup the shade

Open the Eve app and tap Add Accessory. Eve will now guide you through the setup process. If you have previously set up an accessory, go to Settings and tap Add Accessory.

The end positions of the **shade**, top and bottom, are pre-programmed. These can be adjusted by following the steps in the app.



Add Accessory

