

# LEVOLOR®

## Roman Shades Persianas romanas

INSTALLATION • OPERATION • CARE  
INSTALACIÓN • FUNCIONAMIENTO • CUIDADO



Motorized Control Lift  
Elevación con control motorizado

# CONTENTS

---

## Getting Started

Window and Shade Terminology .....	3
Product View .....	4
Components Included .....	5
Tools and Fasteners You May Need .....	6

## Installation

Installation Overview .....	7
Inside Mount (IM) .....	7–10
Outside Mount (OM) .....	11–14
Valance Installation .....	15

## Operation

Remote Operation .....	16
Battery Charging .....	16
Removing the Shade .....	16

## Additional Information and Support

Troubleshooting .....	17
Cleaning Procedures .....	18
Warranty .....	19
Customer Service Support .....	19



**WARNING:** Keep all small parts, components and packaging away from children as they pose a potential choking hazard which may result in serious injury or death. Please reference all warning tags and labels in the instructions and on the shade.

# WINDOW AND SHADE TERMINOLOGY

Thank you for purchasing LEVOLOR® Roman Shades. With proper installation, operation, and care, your new roman shade will provide years of beauty and performance. Please thoroughly review this instruction booklet before beginning installation.

## MOUNTING TYPES AND WINDOW TERMINOLOGY

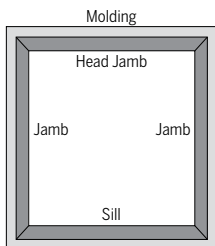

### Window Components Terminology

- Collectively, the sill and jambs are called the “window casement” or “frame”.

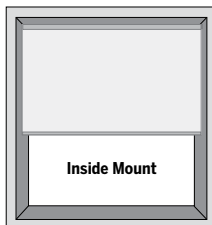

### Inside Mount

- Shade fits within window opening.
- Great for windows with beautiful trim.

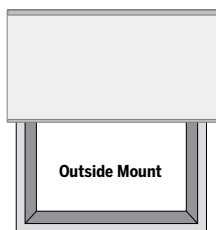

### Outside Mount

- Shade mounts outside window opening.
- Increased light control and privacy.

### Minimum Depth Requirements for Proper Shade Installation (inches)

Operating System	Minimum Mounting Depth	Minimum Depth for Fully Recessed / Flush Mount Headrail
Motorized	1¼"	2¼"

# GETTING STARTED

## PRODUCT VIEW

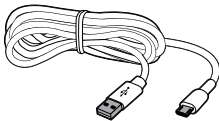
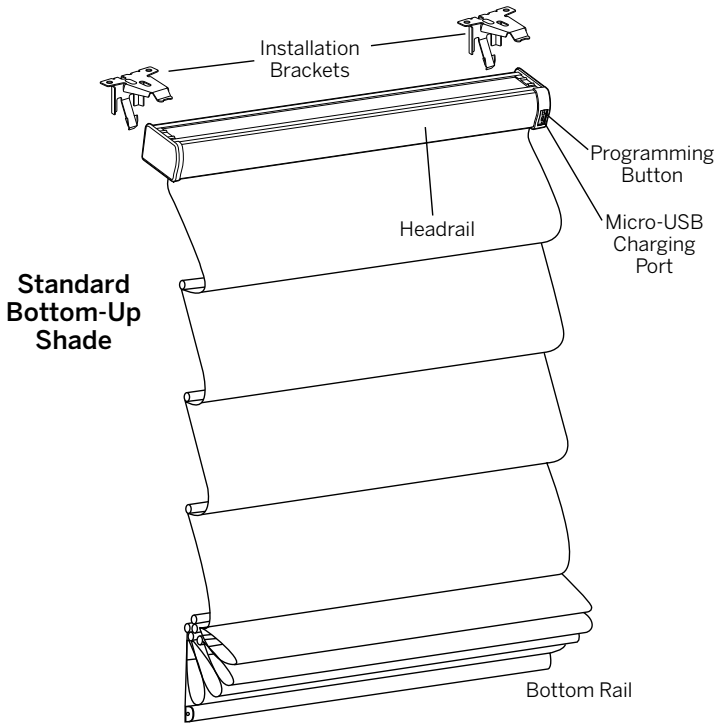

Micro-USB Charging Cable

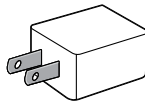

Power Adapter

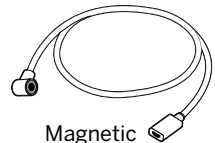

Magnetic Charging Adapter

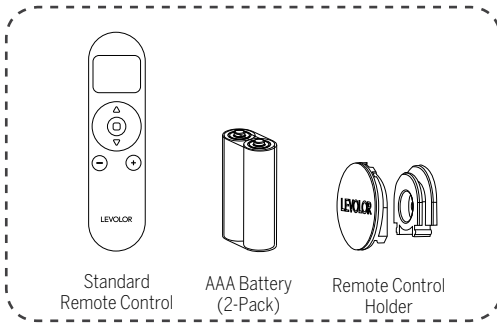

Remote Control Kit (optional)



Hub (optional)

**COMPONENTS INCLUDED**



Roman Shade



Hex Head Screws  
(2 per bracket)



#6 Flat Head Screw for  
Use with End Mounts  
(provided)



Speed Nut and Screw  
(two provided with each  
extension bracket)

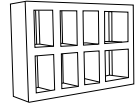

Spacer Block  
(optional)

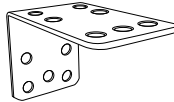
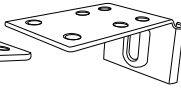
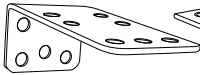

Extension / Side Mount Brackets  
(optional)

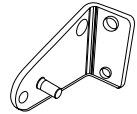

Hold-Down Bracket  
(optional)

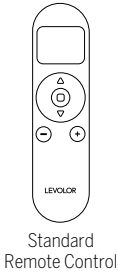
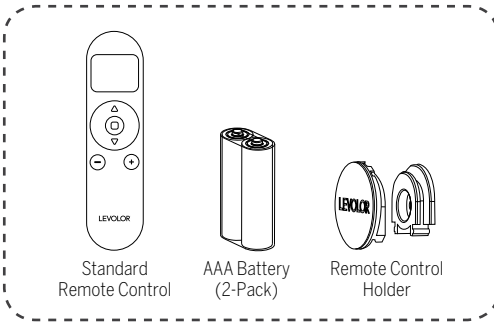

Standard  
Remote Control

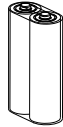

AAA Battery  
(2-Pack)

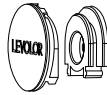

Remote Control  
Holder

Remote Control Kit  
(optional)



Hub  
(optional)

- Shade
- Mounting Brackets
- Installation Hardware
- Remote Control Kit
- Other accessories (optional)

Optional items will be included,  
if selected at time of shade order.

## GETTING STARTED

---

### TOOLS AND FASTENERS YOU MAY NEED (not included)

The tools you will need for installing your shade will vary, depending on the installation surface, and mounting bracket type.

Tools typically used for installation include:

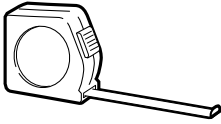

Metal Tape Measure

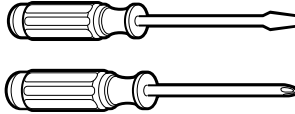

Screwdrivers  
(both flat and Phillips head)



1/4" Nutdriver



Safety Glasses

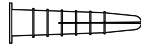

Drywall Anchors



Pencil

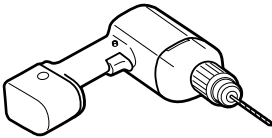

Drill with Bits  
3/32" drill bit &  
1/4" hex driver



Level

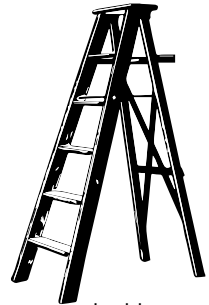

Ladder

**Note:** Longer screws may be needed with extension brackets and spacers, not shown.



**CAUTION:** Use drywall anchors (not provided) when mounting into drywall. Failure to properly anchor shade could cause shade to fall, possibly resulting in injury.

## INSTALLATION OVERVIEW

- **IMPORTANT:** If bound, do not remove binding until the shade is installed in the window.
- Your order will include the correct number of installation brackets for your shade width, as shown in the table.

Shade Width	Brackets Required
Up to 38"	2
38" – 68"	3
68" – 82"	4
82" – 106"	5
106" – 130"	6
> 130"	7

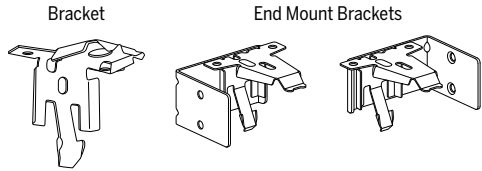

## INSIDE MOUNT (IM) – BEFORE YOU BEGIN

### PAIR SHADE BEFORE INSTALLING

#### REMOTE CONTROL

- Use the **-** and **+** buttons to select the channel to pair to.
- Press and hold the programming button on the window covering for about 2 seconds until the shade jogs once.
- In the next 10 seconds, press and hold the **□** on the remote until the shade jogs twice.

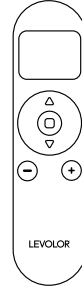

#### USING THE INMOTION APP

- If you purchased a hub, download the LEVOLOR InMotion™ app to get started.
- Shade can be directly paired to app, but it is recommended to pair to remote first.

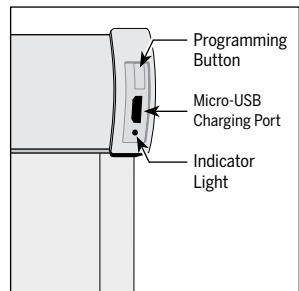

# INSTALLATION

## INSIDE MOUNT (IM)

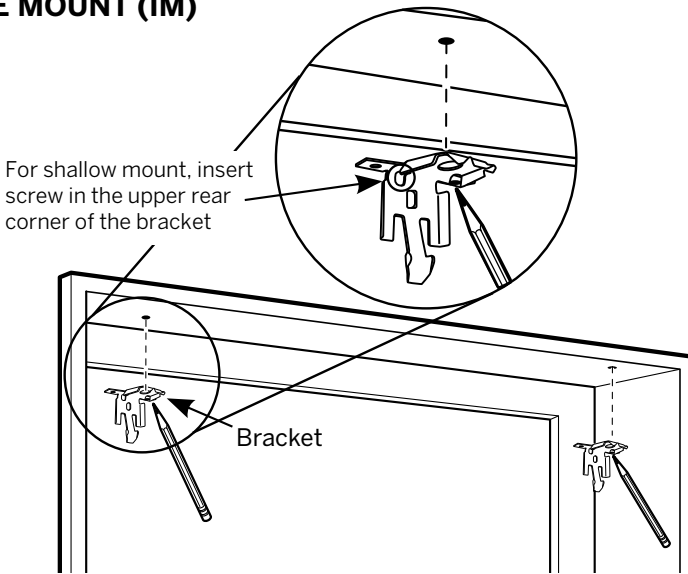

### STEP 1: MARKING THE BRACKET LOCATIONS

- Mark 2" in from each jamb for bracket location. Mount into wood whenever possible.
  - If more than two installation brackets came with your order, space additional bracket(s) evenly between the two end brackets.

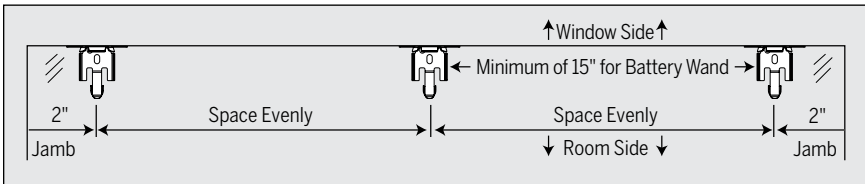

- Center the brackets on your marks, then mark each of the screw holes.
  - The minimum depth for installation brackets is 1¼".
  - The minimum depth for a fully recessed mount is 2¼".
  - Use the center screw hole when depth permits.
  - For shallow mounting depths, use the hole located in the upper rear corner of the bracket.



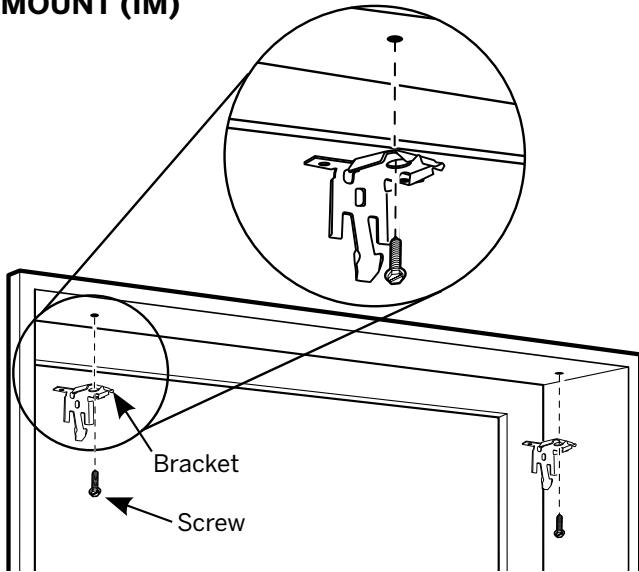

**INSIDE MOUNT (IM)****STEP 2: INSTALLING THE BRACKETS**

- Drill the screw holes using a  $\frac{3}{32}$ " drill bit (use drywall anchors to mount into drywall).
- Attach the installation brackets using the screws provided, 1 screw per bracket.
- Ensure all brackets are square with each other.

# INSTALLATION

## INSIDE MOUNT (IM)

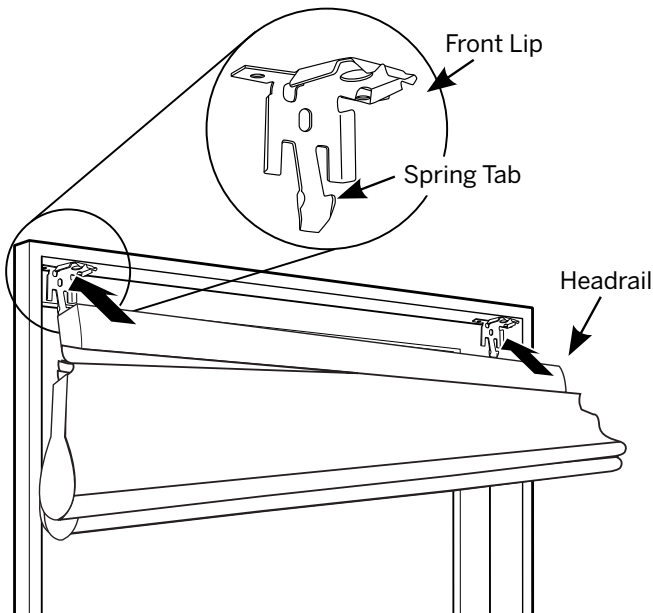

### STEP 3: INSTALLING THE SHADE – MOUNTING THE HEADRAIL

- Fit the front channel on top of the headrail onto the front lip of installation brackets.
- Push the headrail up and back until it snaps into place.
- Check to ensure the headrail is securely in the brackets.
  - Check that the bottom of the headrail is snapped into the base of each bracket.
  - Check that the front lip of each bracket is in the front channel of the headrail.
  - If any brackets are not installed correctly, release the shade and reinstall. See “Removing the Shade (If Necessary)” on page 16.

The front of the bracket fits under the groove.

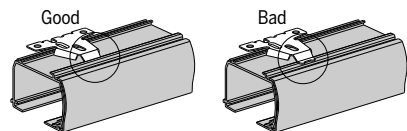
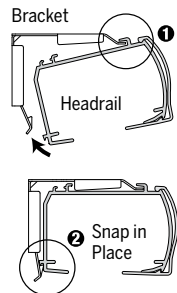

## OUTSIDE MOUNT (OM) – BEFORE YOU BEGIN

### PAIR SHADE BEFORE INSTALLING

#### REMOTE CONTROL

- Use the – and + buttons to select the channel to pair to.
- Press and hold the programming button on the window covering for about 2 seconds until the shade jogs once.
- In the next 10 seconds, press and hold the  on the remote until the shade jogs twice.

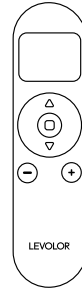

#### USING THE INMOTION APP

- If you purchased a hub, download the LEVOLOR InMotion™ app to get started.
- Shade can be directly paired to app, but it is recommended to pair to remote first.

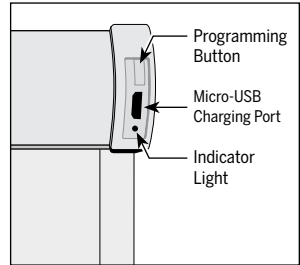

### OUTSIDE MOUNT (OM)

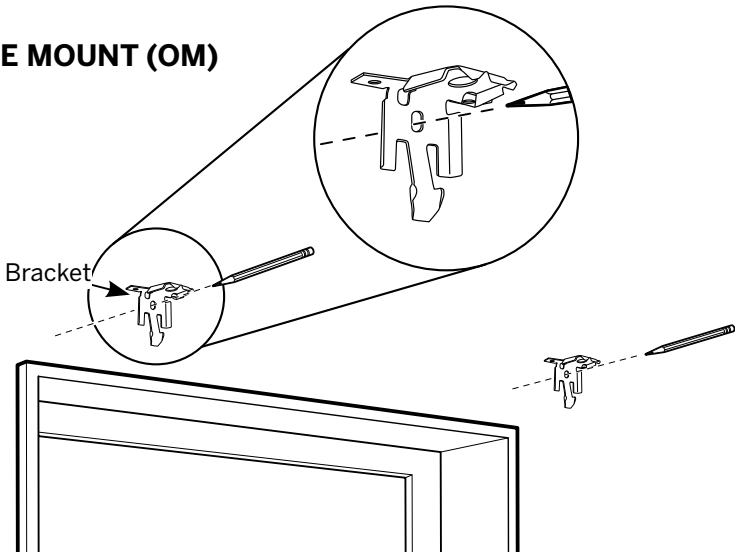

### STEP 1: MARKING THE BRACKET LOCATIONS

**NOTE:** The rear of the brackets must be flush against a flat mounting surface. Do NOT mount brackets on curved molding.

- Center the headrail over the window opening at the desired height.

# INSTALLATION

## OUTSIDE MOUNT (OM)

### STEP 1: MARKING THE BRACKET LOCATIONS, CONT.

- Use a pencil to lightly mark each end of the headrail.
  - Alternatively, measure the width of the headrail and use that width to mark the headrail end points over the window opening.
- Mark approximately 1–2" in from each end of headrail for the installation bracket locations.
  - Allow a minimum of  $\frac{1}{4}$  in. between the bottom of the installation bracket and the top of the window molding.
- With a pencil, mark the installation brackets or extension bracket screw locations through the larger, oblong rear holes of the bracket, 1 screw per bracket.
- Use a level to ensure all brackets are aligned.
- If more than two installation brackets come with your order, space additional bracket(s) evenly between the two end brackets, no more than 30" apart, mark drill hole locations.

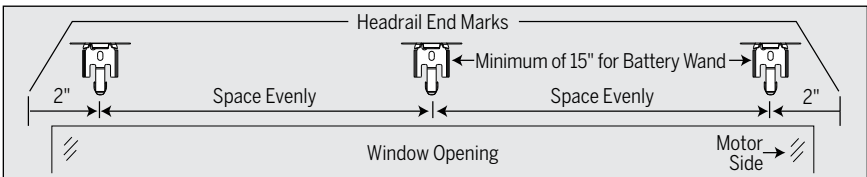

- Center the brackets on your marks, then mark each of the screw holes.
  - A minimum of  $1\frac{1}{4}$ " flat vertical surface is required to mount the brackets.
  - The top of the installation brackets or extension brackets should be at the desired shade height. The brackets should be level and aligned.
  - When using extension brackets, mark two screw holes per bracket.

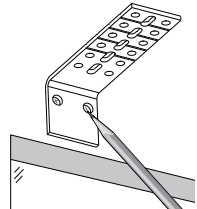

**CAUTION:** The rear of the brackets must be flush against a flat mounting surface. Do not mount brackets on curved molding.

## OUTSIDE MOUNT (OM)

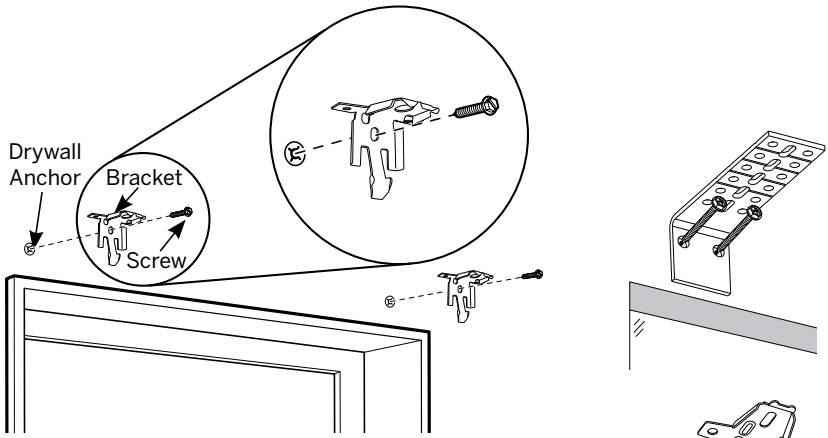

### STEP 2: INSTALLING THE BRACKETS

**NOTE:** Use drywall anchors when mounting into drywall.

- Drill the screw holes using a  $\frac{3}{32}$ " drill bit.
  - Attach the installation or extension brackets using the screws provided.
- IMPORTANT:** The front edges of the installation brackets must be level and aligned to each other.
- If using spacer blocks for added clearance, the spacer blocks and shims may be stacked.
    - A maximum of  $1\frac{1}{2}$ " of added clearance using spacer blocks and shims is recommended.
  - Attach the spacer blocks and installation brackets to a flat vertical mounting surface with #6 mounting screws long enough for a secure installation.
    - The top of the spacer blocks should be at the desired shade height.
    - If using extension brackets, attach an installation bracket to the underside of each extension bracket using the provided screws and speed nuts.

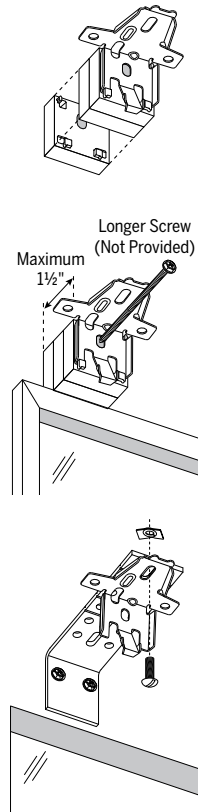

# INSTALLATION

## OUTSIDE MOUNT (OM)

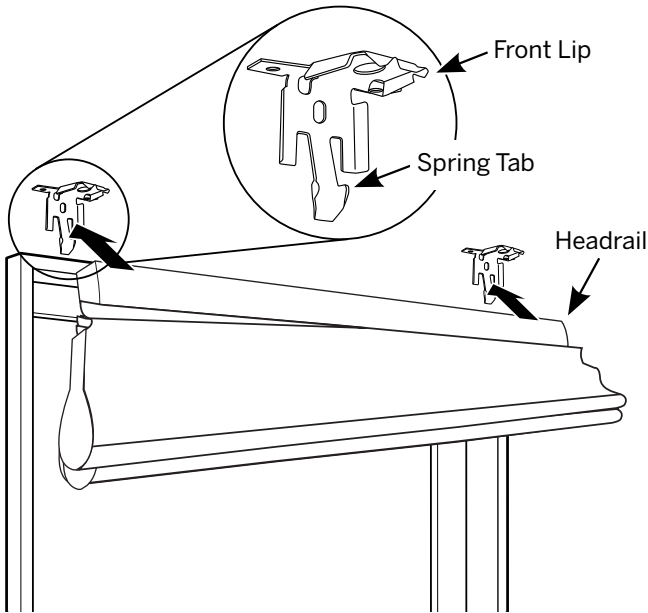

### STEP 3: INSTALLING THE SHADE—MOUNTING THE HEADRAIL

- Fit the front channel on top of the headrail onto the front lip of installation brackets.
- Push the headrail up and back until it snaps into place.
- Check to ensure the headrail is securely in the brackets.
  - Check that the bottom of the headrail is snapped into the base of each bracket.
  - Check that the front lip of each bracket is in the front channel of the headrail.
  - If any brackets are not installed correctly, release the shade and reinstall. See “Removing the Shade (If Necessary)” on page 16.

The front of the bracket fits under the groove.

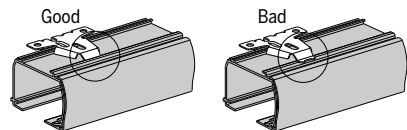
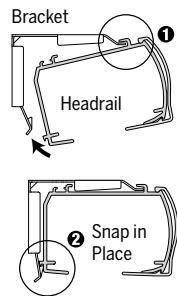

### INSTALL VALANCE

**IMPORTANT:** Pair remote prior to installing the valance.

- Hook the top of the valance over the top lip of the headrail.
- Carefully press the valance down and back against the headrail until the valance clips into place.

### ATTACH VALANCE RETURNS

**(Outside mount only)**

- Fold the valance returns around the end of the headrail and firmly press into place so that the hook-and-loop strips engage.

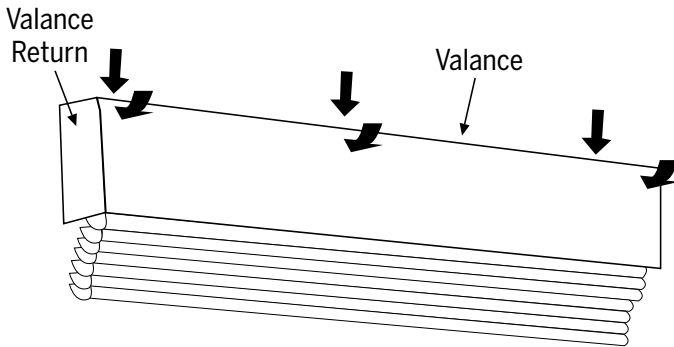

# OPERATION

## REMOTE OPERATION

- Scan for remote guide.



## BATTERY CHARGING

- Rechargeable battery is integrated into shade headrail.
- For standard charging, remove the magnetic charging insert from the headrail. Use the micro-USB charging cable and power adapter to charge shade.
- For easier access to the charging port, a removable magnetic charging adapter has been installed during production. Attach the magnetic charging adapter to the micro-USB charging cable and power adapter before connecting to headrail to charge.
- Indicator light battery status:
  - Low (red flash)
  - Charging (green flash)
  - Charged (green solid)
- It is recommended to fully charge shade prior to first use.

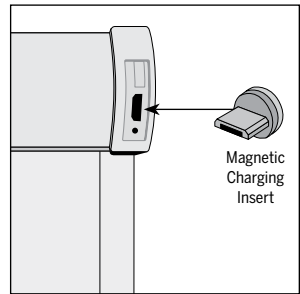
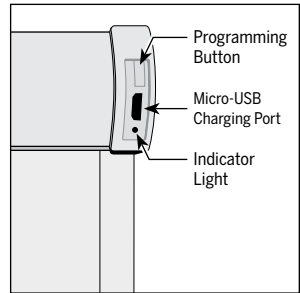

## REMOVING THE SHADE (IF NECESSARY)

- Lower the shade approximately 4".
- While holding the headrail, push back on the bottom tab of the installation bracket to release the bottom edge of the headrail.
- After releasing the bottom edge, roll the back of the headrail down and out from the bracket.

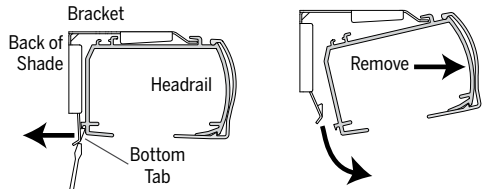



## TROUBLESHOOTING

If your shade is not operating correctly:

- First review the guide that came with your control device.
- Refer to the following troubleshooting procedures for specific solutions for your shade.

If questions remain, please contact LEVOLOR Customer Service at 1-800-LEVOLOR or 1-800-538-6567.

<b>Problem</b>	<b>The shade will not fit into the installation brackets.</b>
<b>Solution</b>	<p>Check that the installation brackets are level and aligned. Adjust and/or shim to level, if necessary.</p> <p>Be sure the heads of the mounting screws are flush against the installation bracket.</p> <p>Make sure that the shade fabric is not caught between the installation bracket and the headrail.</p> <p>Check that the headrail is completely inserted into the installation brackets.</p>
<b>Problem</b>	<b>The shade raises or lowers unevenly or the bottom rail is uneven when fully raised.</b>
<b>Solution</b>	<p>Lower the shade completely to allow it to “self-correct” skewing.</p> <p>Check that the headrail and installation brackets are level and aligned. Shim the installation brackets to level the headrail, if necessary.</p> <p>Adjust roman bar clips. Lower the shade completely and locate the cord route in the top of the headrail behind the shade. On the back of the shade, adjust any roman bar clips by hand that are out of vertical alignment with the cord location in the headrail.</p>

## ADDITIONAL INFORMATION AND SUPPORT

---

### CLEANING PROCEDURES

A brush-type vacuum attachment or feather duster should be used for cleaning. If your shade should become stained, you may clean it by dabbing the spot with a sponge dampened with lukewarm water. Do not immerse shade in water. Avoid contact with window cleaning products as these may discolor your shade. Ultrasonic cleaning is not recommended or covered by our warranty. Improper cleaning may damage the shade and void warranty.



#### DUSTING

Use a feather duster for regular cleaning.



#### FORCED AIR

Blow away dirt and debris using clean compressed air.



#### PROFESSIONAL INJECTION/EXTRACTION CLEANING

Call local on-site blind/shade cleaner that injects a cleaning solution into the fabric and extracts the dirty solution at the same time. The service is typically performed at home so you do not need to remove your window treatments.



#### VACUUMING

Use a low suction vacuum with a brush-type cleaner attachment; stroke lightly over the shade to clean.



#### SPOT-CLEANING/STAIN REMOVAL AT HOME

Use warm water and a mild soap, like Woolite® or Scotchgard®, if needed. Do not immerse shade in water.

### Additional Notes

- Once mounted, leave the shade in the lowered position for 48 hours to release any wrinkles in the fabric.
- Shades made from patterned fabrics may differ slightly in the location of of the pattern from shade to shade. This is due to normal variation in the roll from which the fabric is cut for the shade.
- With time, soft folds may settle or flatten. Shades that are raised regularly will be less subject to settling and will maintain a more relaxed appearance.

# LEVOLOR®

## InMotion™ Motorization



### Solar Panel Installation and Reference Guide

Declarations .....	2
Safety Instructions .....	3
InMotion™ Solar Panel Overview .....	4
Before Installation – What you need to know .....	5
InMotion™ Solar Panel Installation Guide .....	7
Troubleshooting .....	9

# DECLARATIONS

## U.S. Radio Frequency FCC Compliance

This device complies with Part 15 of the FCC Rules. Operation is subject to the following two conditions:

- (1) This device may not cause harmful interference, and
- (2) This device must accept any interference received, including interference that may cause undesired operation.

This equipment has been tested and found to comply with the limits for a Class B digital device, pursuant to Part 15 of the FCC Rules. These limits are designed to provide reasonable protection against harmful interference in a residential installation. This equipment generates, uses, and can radiate radio frequency energy and, if not installed and used in accordance with the instructions, may cause harmful interference to radio communications. However, there is no guarantee that interference will not occur in a particular installation. If this equipment does cause harmful interference to radio or television reception, which can be determined by turning the equipment off and on, the user is encouraged to try to correct the interference by one or more of the following measures:

- Reorient or relocate the receiving antenna.
- Increase the separation between the equipment and receiver.
- Connect the equipment into an outlet on a circuit different from that to which the receiver is connected.
- Consult the dealer or an experienced radio/TV technician for help.

*Any Changes or modifications not expressly approved by the party responsible for compliance could void the user's authority to operate the equipment.*

## ISED RSS Warning:

This device complies with Innovation, Science and Economic Development Canada license-exempt RSS standard(s). Operation is subject to the following two conditions: (1) this device may not cause interference, and (2) this device must accept any interference, including interference that may cause undesired operation of the device. Le présent appareil est conforme aux CNR d'ISED applicables aux appareils radio exempts de licence. L'exploitation est autorisée aux deux conditions suivantes: (1) l'appareil ne doit pas produire de brouillage, et (2) l'utilisateur de l'appareil doit accepter tout brouillage radioélectrique subi, même si le brouillage est susceptible d'en compromettre le fonctionnement.

# SAFETY INSTRUCTIONS

## ATTENTION: IMPORTANT SAFETY INSTRUCTION TO BE READ BEFORE INSTALLATION:

- Any changes or modifications to this unit not expressly approved by the party responsible for compliance could void the user's authority to operate the equipment.
- Incorrect installation can lead to serious injury and will void manufacturer's liability and warranty.



## IMPORTANT SAFETY INSTRUCTIONS TO BE READ PRIOR TO OPERATION:

- It is important for the safety of persons to follow the enclosed instructions. Save these instructions for future references.
- Persons (including children) with reduced physical, sensory or mental capabilities, or lack of experience or knowledge should not be allowed to use this product.
- Keep Solar Panel away from children.
- Frequently inspect for improper operations. Do not use if repair or adjustment is necessary.

## IMPORTANT SAFETY INSTRUCTIONS:

- Do not expose motor to moisture or extreme temperature.
- Do not allow children to play with this device.
- Use or modification outside the scope of this instruction manual will void warranty.
- Installation and programming to be performed by a suitable quality installer.
- For use with Li-ion motors and rechargeable battery packs only.
- Do not cut power cables.
- NOT suitable for exterior application.
- Do not drill into motor body or solar panel body.
- The routing of cable through walls shall be protected by isolating bushing or grommets.
- Ensure power cable is clear and protected from moving parts.
- If cable or power connector is damaged do not use.



Do not dispose of in general waste.

Please recycle batteries and damaged electrical products appropriately.

# INMOTION™ SOLAR PANEL OVERVIEW

## AVAILABLE PRODUCTS

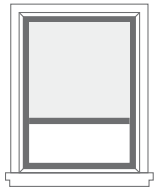

Roller Shades

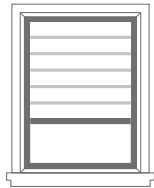

Sheer Shadings

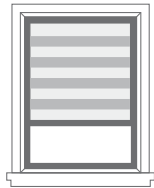

Banded Shades

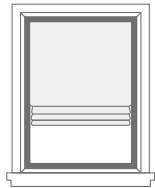

Natural Woven

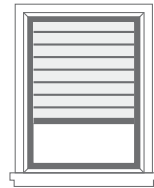

Cellular Shades

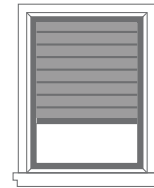

Wood/Faux  
Tilt-Only

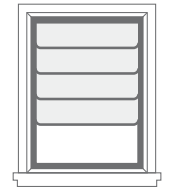

Roman Shades

## SPECIFICATIONS

Working Voltage (Vm):	5V
Open circuit voltage (Voc):	6.3V
Short-circuit current (Isc):	659mA
Working current (Im):	606mA
Max. Output Power (Under 1000W/m2):	3W

Electrical performance tolerance:	voltage $\pm 10\%$ ; current $\pm 10\%$
International solar energy inspection standards:	solar radiation 1000W/m2; 1.5 Air Mass; humidity 25° C
Electricity requirements (each solar panel includes solar battery cells):	conversion efficiency 21%; open circuit voltage (Voc) 6.3V
IP Rating:	IP55
Temp Working Range:	14°F to 122°F (-10°C to 50°C)

## DIMENSIONS

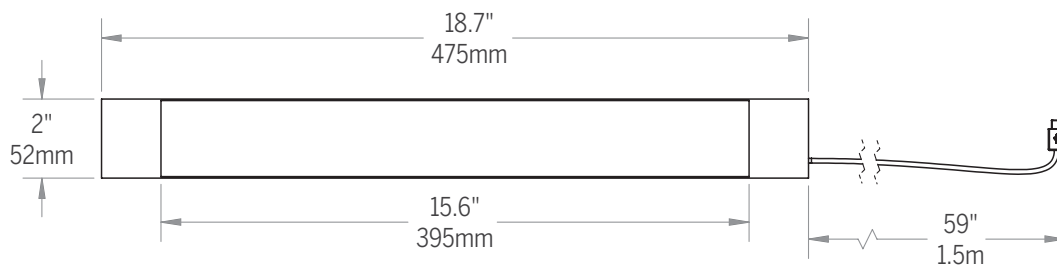

## SOLAR PANEL PARTS

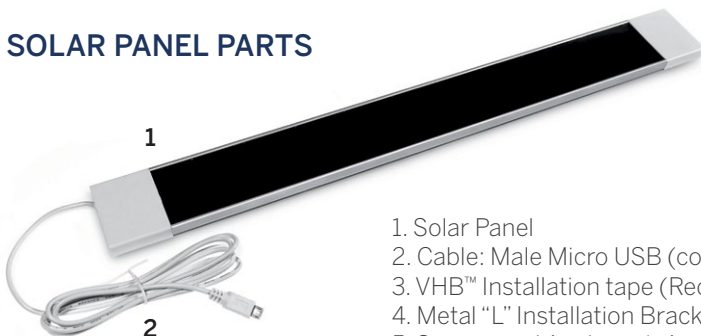

1. Solar Panel
2. Cable: Male Micro USB (compatible with all InMotion™ rechargeable battery products)
3. VHB™ Installation tape (Recommended method)
4. Metal "L" Installation Bracket (Alternative method)
5. Screws and Anchors (x4pcs)

# BEFORE INSTALLATION – WHAT YOU NEED TO KNOW

## CONSIDER THE GEOGRAPHIC LOCATION OF THE INSTALLATION

Understanding the sun’s motion relative to a site is a crucial element to predict the solar panel performance. In other words, a solar panel located in Texas will harvest more energy than a unit installed in Canada (considering both facing south, using similar window). The same can be said between Summer and Winter harvest performance.

As a main recommendation, installations on northern areas are recommended only for small and middle size shades (up to 48" x 60"), with up to one cycle per day. More aspects affect the performance of solar panels and should be considered, not being possible a “one size fits all” approach.

Understanding the sun’s motion relative to a site is a crucial element to predict the solar panel performance. A solar panel located in Texas will harvest more energy than a unit installed in Canada (considering both facing south, using similar window).

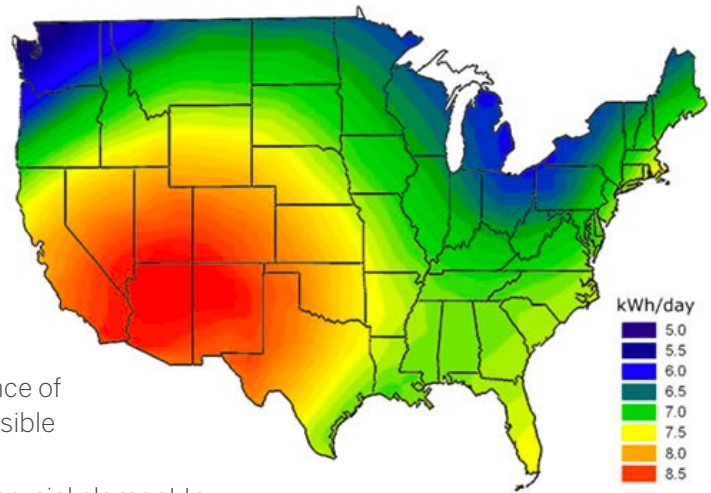

Source: <http://www.fsec.ucf.edu>

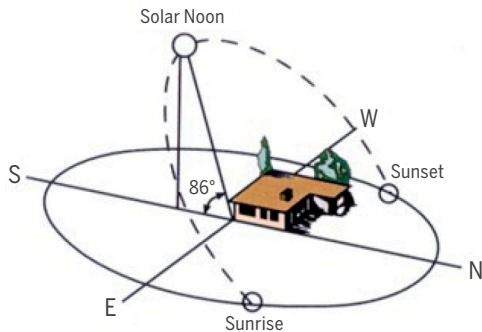

Sun's path on Summer solstice at a southern latitude

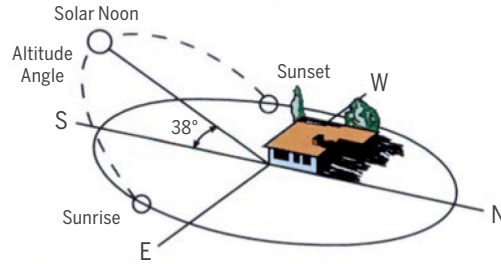

Sun's path on Winter solstice at a southern latitude

The Solar Panel may not be a good fit for every window. In the summer, the sun rises higher in the sky than in the winter months. The further north, the lower the midday winter sun will be. Due to the sun position, Solar panels installed facing north produce 4 times less energy than a device installed facing south. For this reason, we do not recommend the use of solar panel on windows facing North.

	Summer Performance	Winter Performance
South Face	100%	70%
West Face	95%	90%
East Face	90%	70%
North Face	60%	25%

# BEFORE INSTALLATION – WHAT YOU NEED TO KNOW

## DEFINE THE BEST LOCATION TO INSTALL

The solar panel is designed for indoor use only. To maximize the performance of the solar panel, it should be installed as close as possible to the window glass, allowing as much natural light as possible to reach the panel.

### Important

Any element between the Sun light and the solar panel will impact the charging time, and in some situations, prohibit the use of a solar panel. Overcast weather is an example of possible obstruction that impossible to predict or control, but there are other elements that we should consider before installing a solar panel, like:

- Awnings
- Trees
- Deep Eaves
- Tall buildings and walls
- Insect Screen
- Others



### Do Not Use Solar Panel Under Below Conditions

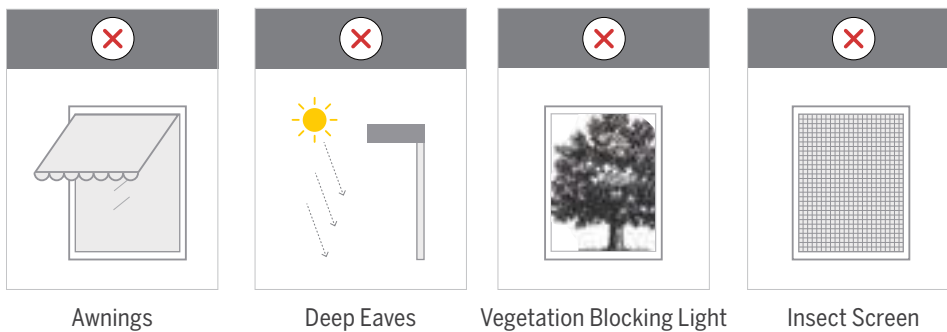

Awnings

Deep Eaves

Vegetation Blocking Light

Insect Screen

Other elements are not so obvious but can make it difficult to use a solar panel. The solar panel will have a low performance when installed on locations with:

- Tinted windows
- High performance glass (also known as energy efficiency glass)
- Multi panel glass
- Any window with treatment that reduces the light transmission below 65%
- Window dividers overlapping solar panel

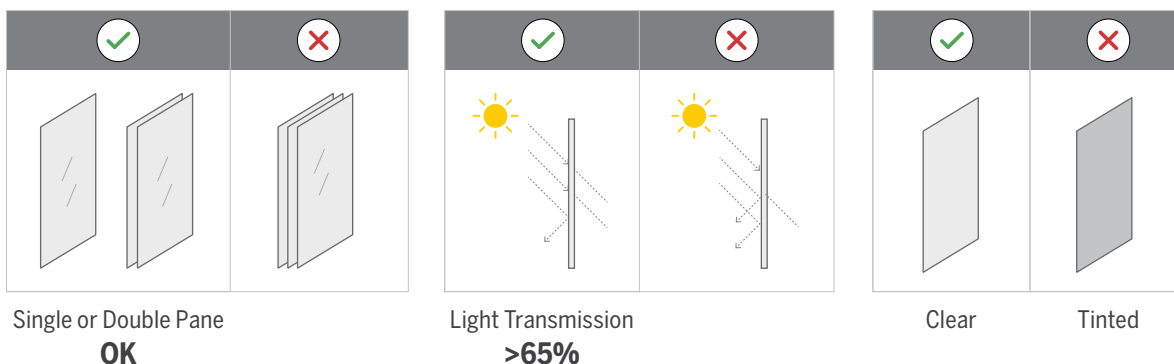

Single or Double Pane  
**OK**

Light Transmission  
**>65%**

Clear

Tinted



## BEFORE INSTALLATION – WHAT YOU NEED TO KNOW

### HOW EFFICIENT WILL MY SOLAR PANEL PERFORM?

There is no direct answer for this question. Beside all the elements already described that impact how much energy will be harvested from the sun, there is also the question of how fast the energy will be drained by the shade itself due to:

- Shade composition (fabric weight)
- Number of cycles per day
- Size of shade (how long the motor will run per cycle)

The answer for these questions should be considered to evaluate if the solar panel is the best fit for the application.

## INMOTION™ SOLAR PANEL INSTALLATION GUIDE

The solar panel must always be install indoors, directly against the window glass to allow as much natural light as possible to reach the panel. For your convenience, the solar panel can be installed using VHB™ installation tape (recommended method) or Metal “L” Installation Bracket (alternative method).

### INSTALLATION USING PROVIDED INSTALLATION TAPE

First, clean solar panel corners and window area using alcohol and a cloth pad. Let dry for a few minutes. On a flat surface, place the solar panel facing up and carefully apply the VHB™ installation tape on both sides of the solar panel.



Remove the “face” of the applied adhesive. Position the solar panel facing to outdoors, then press entire panel with firm, even pressure into the glass for 10–15 seconds. The panel is now supported by the adhesive to glass bond but will require 24 hours of cure time to allow full strength characteristics. Do not disturb during this period.

# INMOTION™ SOLAR PANEL INSTALLATION GUIDE

## ATTACHING “L” INSTALLATION BRACKET TO WINDOW FRAME

The “L” installation bracket is provided as an option when an installation direct on the glass is not possible. A common application is to mount the “L” Bracket on the window frame – either top mount or side mount. Ensure the Solar panel and it’s bracket are not blocking the free movement of the bottom rail.

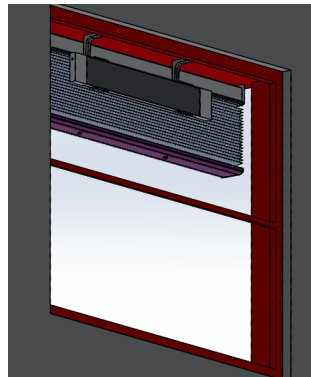

Top Mount



Side Mount

First, install the mounting bracket to wall/mounting point using the screws provided.



Next, adjust the bracket length by lengthening or shortening the “extendable” bracket with the 2 screws.

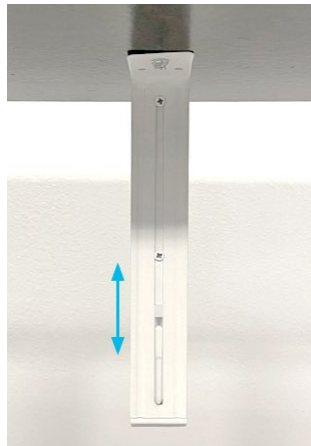

Finally, attach the solar panel into the installation bracket, position the bracket in the center of the solar panel.



# INMOTION™ SOLAR PANEL INSTALLATION GUIDE

## CONNECT WITH BUILT IN RECHARGEABLE BATTERY MOTOR

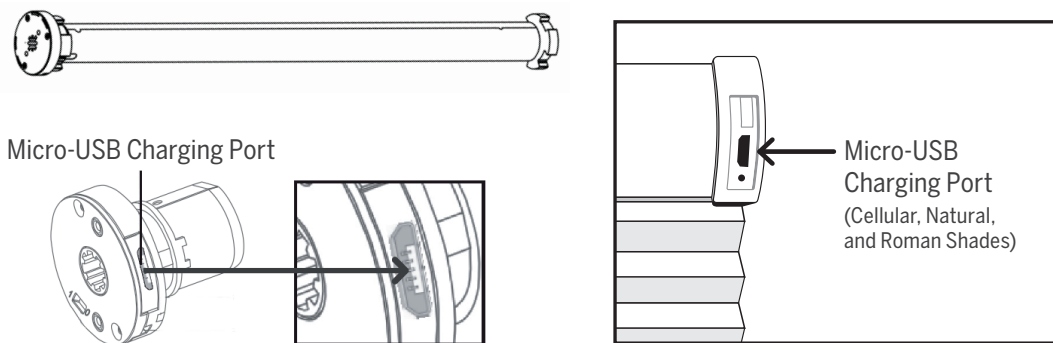
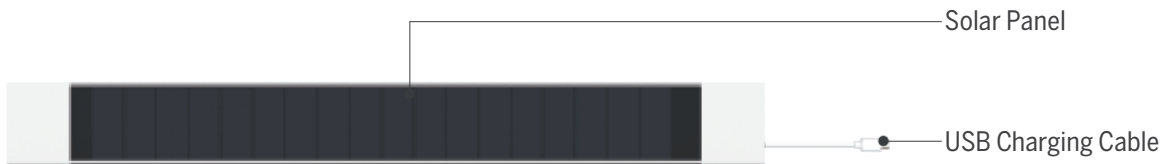

## TROUBLESHOOTING

Issues	Possible Causes	Solution
The motor has no response	Battery in motor is depleted	Recharge with compatible charger and check connection and positioning of solar panel
	Insufficient charging from solar panel	Check connection and orientation of solar PV panel
	Remote control battery is discharged	Replace battery
	Battery is inserted incorrectly into remote control	Check battery polarity
	Radio interference/shielding	Ensure remote control and the antenna on the motor are positioned away from metal objects
	Motor/receiver distance is too far from remote control	Move remote control to a closer position
	Power failure	Check power supply to motor is connected and active
	Incorrect wiring	Check that wiring is connected correctly (refer to motor installation instructions)
Motor beeps 10 times when in use	Battery voltage is low/PV (solar panel issue)	Recharge with charger or check connection and positioning of solar panel

# LEVOLOR®

## InMotion™ Motorization



### SURFACE MOUNTED WALL SWITCH

#### PROGRAMMING AND USERS GUIDE

#### SPECIFICATIONS

<b>Voltage</b>	3V (CR2430)
<b>Radio Frequency</b>	433.92 MHz Bi-directional
<b>Transmitting Power</b>	10 milliwatt
<b>Operating Temperature</b>	14°F to 122°F (-10°C to 50°C)
<b>RF Modulation</b>	FSK
<b>Lock Function</b>	Yes
<b>IP Rating</b>	IP20
<b>Transmission Distance</b>	up to 200m (outdoor)

#### SAFETY INSTRUCTIONS

1. Do not expose motor to humid, damp, or extreme temperature conditions.
2. Do not drill into motor.
3. Do not cut the antenna. Keep it clear from metal objects.
4. Do not allow children to play with this device.
5. If the power cable or connector is damaged, do not use.
6. Ensure the power cable and antenna are clear and protected from moving parts.
7. Cable routed through walls should be properly isolated.
8. Motor should be mounted in horizontal position only.
9. Before installation, remove unnecessary cords and disable equipment not needed for powered operation.



Do not dispose of in general waste.  
Please recycle batteries and damaged electrical products appropriately.

23-0006-050

# WALL SWITCH OVERVIEW

Please read prior to installation and use. Save these instructions for future reference.

## BUTTON INSTRUCTIONS

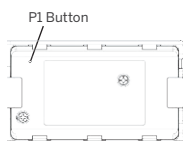
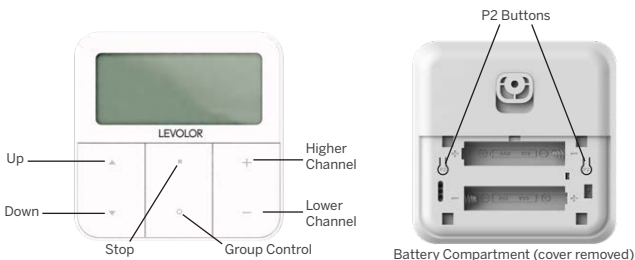

**HORIZONTAL BLIND TILT**

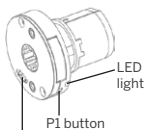

**ROLLER / SHEER BANDED**

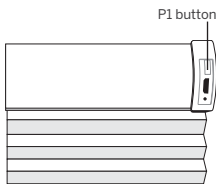

**CELLULAR / NATURAL / ROMAN SHADES**

## REPLACING THE BATTERY

- Gently press down the cover and slide it down.
- Install 2 AAA batteries with the + and - ends facing correctly.
- Slide the cover back onto the backside.

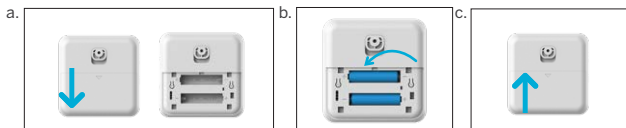

## ADVANCED SETTING - DISABLE LIMIT SETTING

a. Press and hold "Stop" button more than 15s. Wall Switch will show "L" (lock).

b. In the next 10s, press one "P2" button on the back of Wall Switch. Wall Switch will show "o", then the Wall Switch switches to "Lock" mode to disable the following commands:

- Change Motor Direction
- Setting the Upper and Lower Limit
- Adjust Limit
- Roller Mode or Sheer Mode

c. Press and hold "Stop" button more than 15s. Wall Switch will show "U" (unlock).

d. In the next 10s, press one "P2" button on the back of Wall Switch. Wall Switch will show "o". The Wall Switch now switches to "Unlock" mode, you can access all control functions.

\*This advanced feature is intended to be used after all shade programming is completed. User Mode will prevent accidental or unintended changing of limits.

a. **Action on Wall Switch**      **Wall Switch Response**



**Wall Switch Response**

## DECLARATIONS

### U.S. Radio Frequency FCC Compliance

This device complies with Part 15 of the FCC Rules. Operation is subject to the following two conditions:

- (1) This device may not cause harmful interference, and
- (2) This device must accept any interference received, including interference that may cause undesired operation.

This equipment has been tested and found to comply with the limits for a Class B digital device, pursuant to Part 15 of the FCC Rules. These limits are designed to provide reasonable protection against harmful interference in a residential installation. This equipment generates, uses, and can radiate radio frequency energy and, if not installed and used in accordance with the instructions, may cause harmful interference to radio communications. However, there is no guarantee that interference will not occur in a particular installation. If this equipment does cause harmful interference to radio or television reception, which can be determined by turning the equipment off and on, the user is encouraged to try to correct the interference by one or more of the following measures:

- Reorient or relocate the receiving antenna.
- Increase the separation between the equipment and receiver.
- Connect the equipment into an outlet on a circuit different from that to which the receiver is connected.
- Consult the dealer or an experienced radio/TV technician for help.

Any Changes or modifications not expressly approved by the party responsible for compliance could void the user's authority to operate the equipment.

### ISED RSS Warning:

This device complies with Innovation, Science and Economic Development Canada license-exempt RSS standard(s). Operation is subject to the following two conditions: (1) this device may not cause interference, and (2) this device must accept any interference, including interference that may cause undesired operation of the device.

## QUICK INDEX

Settings	Steps
1 Pairing	P1 (hold for 2s) > Stop (hold for 2s)
2 Switch Rotating Direction	Up + Down (hold for 2s)
3 Set Upper/Lower Limits	Upper Limit: Up (hold for 2s) > Up + Stop (hold for 2s) Lower Limit: Down (hold for 2s) > Down + Stop (hold for 2s)
4 Add/Remove Fav. Position	P2 > Stop > Stop
5 Roller/Sheer Mode Switch	Up + Down (hold for 5s) > Stop
6 Adjusting the Limits	Upper: Up + Stop (hold for 5s) > Up or Dn > Up + Stop (hold for 2s) Lower: Dn + Stop (hold for 5s) > Up or Dn > Dn + Stop (hold for 2s)
7 Add/Remove a Remote	P2 (existing) > P2 (existing) > P2 (new)
8 Speed Regulation	Increase Motor Speed: P2 > Up > Up Decrease Motor Speed: P2 > Down > Down

## TROUBLESHOOTING

### Problem - The motor has no response

Cause	Solution
Battery in motor is depleted	Recharge with compatible AC adaptor and check connection and positioning of solar panel
Insufficient charging from Solar Panel	Check connection and orientation of solar panel.
Wall switch battery is discharged or not installed properly	Replace battery or check placement.
Radio interference/shielding	Ensure wall switch and the antenna on the motor are positioned away from metal objects.
Receiver distance is too far	Move wall switch to a closer position.
Power failure	Check power supply to motor is connected/active.
Incorrect wiring	Check that wiring is connected correctly.

### Problem - The Motor beeps 10 times when in use

Cause	Solution
Battery voltage is low/Solar Panel Issue	Recharge with AC adapter or check connection and positioning of solar PV panel

### Problem - Cannot program a single motor (multiple motors respond)

Cause	Solution
Multiple Motors are paired to the same	Always reserve a channel for programming. BEST PRACTICE - Provide an extra 15 channel remote in your multi-motor projects for individual control and programming purposes To work on a single motor at a time, place all other motors into sleep mode. Press the "P1" button (about 6 sec) on the motor head until motor jog x2 and beep x2.

## CHANNEL OPTIONS

### SELECT A CHANNEL

a. Press “-” button on the wall switch to select a lower channel.

b. Press “+” button on the wall switch to select a higher channel.

Action on Wall Switch

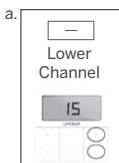

Wall Switch Response

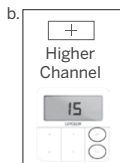

### HIDE UNUSED CHANNELS

a. Press and Hold (about 3 sec) “-” and “+” buttons simultaneously until wall switch displays “C” (channel).

b. Press “-” or “+” button to select required quantity of channel (between 1 to 15).

c. Press “Stop” button to confirm selection (the example shows a 5-channel selection). The LED will display “O” (OK) once to confirm selection.

Action on Wall Switch

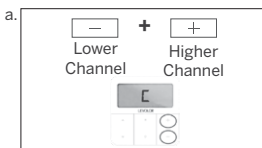

Wall Switch Response

Action on Wall Switch

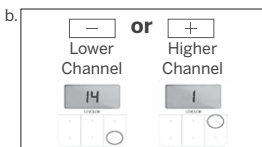

Wall Switch Response

Action on Wall Switch

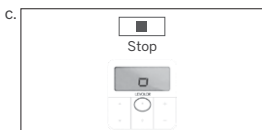

Wall Switch Response

## GETTING STARTED

It is important to confirm that the motor is awake and ready to receive programming. To do this, press “P1” button on the motor less than 1 sec, to activate the motor from Sleep Mode.

### 1. PAIR / UNPAIR WALL SWITCH

\*Cellular, Natural, Roman Shades, and Horizontal Blind Motors DO NOT BEEP.

a. Press “P1” button (about 2 sec) on the motor head until motor jog x1 and beep x1.

b. In the next 10 secs, press and hold “Stop” button on the wall switch until motor jog x2 and beep x3.

\* Repeat the same procedure to unpair wall switch.

Action on Motor



Motor Response

Action on Wall Switch



Motor Response

### 2. CHANGE MOTOR DIRECTION (IF NECESSARY)

Press “Up” or “Down” button to check if the shade moves in the desired direction.

If you need to reverse the direction, press and hold (about 2 sec) “Up” and “Down” buttons simultaneously until motor jog x1 and beep x1.

Action on Wall Switch



Motor Response

\*The operation is only valid when there are no limits. If the motor has already set the upper and lower limit, then you can only switch direction by pressing “P1” button (about 10 sec) on the motor head until motor jog x3 and beep x3.

### 3. SETTING THE UPPER AND LOWER LIMITS

#### SET UPPER LIMIT

a. Press “Up” button to raise the shade, then press “Stop” button when it is in the desired upper limit.

b. Press and hold (about 5 sec) “Up” and “Stop” buttons simultaneously until motor jog x2 and beep x3.

Action on Wall Switch

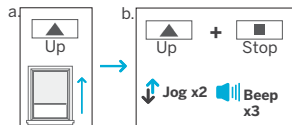

Motor Response

## SET LOWER LIMIT

a. Press **"Down"** button to lower the shade, then press **"Stop"** button when it is in the desired lower limit.

b. Press and hold (about 5 sec) **"Down"** and **"Stop"** buttons simultaneously until motor jog x2 and beep x3.

\*If you exit the limit setting status before you finish the limit settings, the motor will take the previous existing limits.

### Action on Wall Switch

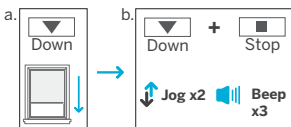

### Motor Response

**Factory Mode Complete  
User Mode Begins**

## 4. ADJUST LIMITS

### ADJUST THE UPPER LIMIT

a. Press and hold (about 5 sec) **"Up"** and **"Stop"** buttons simultaneously until motor jog x1 and beep x1.

b. Use **"Up"** button to raise the shade to the desired highest position, and use **"Up"** or **"Down"** button to do the final adjustment if necessary.

c. Press and hold (about 5 sec) **"Up"** and **"Stop"** buttons simultaneously until motor jog x2 and beep x3.

### Action on Wall Switch

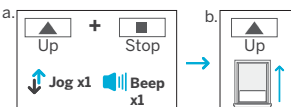

### Motor Response

### Action on Wall Switch

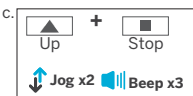

### Motor Response

### ADJUST THE LOWER LIMIT

a. Press and hold (about 5 sec) **"Down"** and **"Stop"** buttons simultaneously until motor jog x1 and beep x1.

b. Use **"Down"** button to lower the shade to the desired lowest position, and use **"Up"** or **"Down"** button to do the final adjustment if necessary.

c. Press and hold (about 5 sec) **"Down"** and **"Stop"** buttons simultaneously until motor jogs x2 and beeps x3.

### Action on Wall Switch

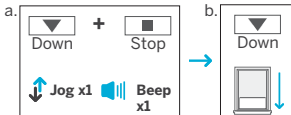

### Motor Response

### Action on Wall Switch



### Motor Response

## 5. FAVORITE POSITION

### SET FAVORITE POSITION

a. Use **"Up"** or **"Down"** button to move the shade to desired Favorite position.

b. Press and hold (about 2 sec) one **"P2"** button on the back of wall switch until motor jog x1 and beep x1.

c. Press and hold (about 2 sec) **"Stop"** button until motor jog x1 and beep x1.

d. Once more, press and hold (about 2 sec) **"Stop"** button until motor jog x2 and beep x3.

### Action on Wall Switch

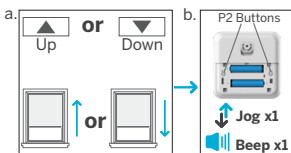

### Motor Response

### Action on Wall Switch

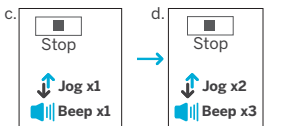

### Motor Response

### SEND SHADE TO FAVORITE POSITION

Press and hold (about 2 sec) **"Stop"** button, motor will move to Favorite position.

### Action on Wall Switch

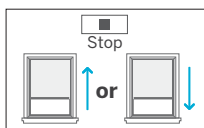

### Shade Response

### DELETE FAVORITE POSITION

a. Press and hold (about 2 sec) one **"P2"** button until motor jog and beep x1.

b. Press and hold (about 2 sec) **"Stop"** button until motor jog and beep x1.

c. Once more, press and hold (about 2 sec) **"Stop"** button until motor jog x1 and long beep x1.

### Action on Wall Switch

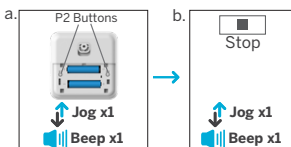

### Motor Response

### Action on Wall Switch



### Motor Response



## 6. ROLLER MODE AND SHEER MODE

**ROLLER SHADE MODE - Default mode, allows for continuous raising/lowering of shade after a short press.**

a. Press and hold (about 5 sec) "Up" and "Down" buttons simultaneously until motor jog x1.

b. Press and hold (about 2 sec) "Stop" button until motor jog x2 and beep x3.

Action on Wall Switch

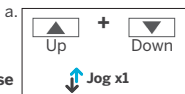

Motor Response

Action on Wall Switch

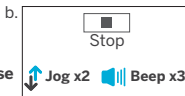

Motor Response

**SHEER SHADE MODE - Allows for slight adjustment after a short press and raising/lowering of shade after a longer press.**

a. Press and hold (about 5 sec) "Up" and "Down" buttons simultaneously until motor jog x1.

b. Press and hold (about 2 sec) "Stop" button until motor jog x1 and beep x1.

Action on Wall Switch

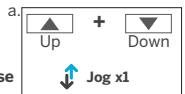

Motor Response

Action on Wall Switch



Motor Response

## 7. ADD OR REMOVE ADDITIONAL WALL SWITCH

**USING CURRENT WALL SWITCH**

a. On the **current** wall switch, press and hold (about 2 sec) one "P2" button until motor jog x1 and beep x1.

b. Once more, on the **current** wall switch, press and hold (about 2 sec) one "P2" button until motor jog x1 and beep x1.

c. On the **New** wall switch, press and hold (about 2 sec) one "P2" button until motor jog x2 and beep x3.

\*Repeat the same procedure to remove additional wall switch.

Action on Wall Switch

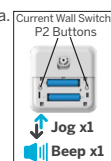

Motor Response

Action on Wall Switch

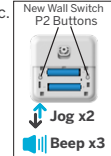

Motor Response

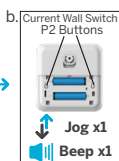

**NEW WALL SWITCH CONTROL**

Follow instructions under the section 1. Pair / Unpair Wall Switch

## 8. ADJUST MOTOR SPEED

**INCREASE MOTOR SPEED**

a. Press one "P2" button until motor jog x1 and beep x1.

b. Press "Up" button until motor jog x1 and beep x1.

c. Once more, press "Up" button until motor jog x2 and beep x1.

Action on Wall Switch

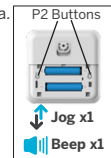

Motor Response

Action on Wall Switch

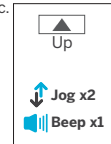

Motor Response

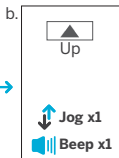

**DECREASE MOTOR SPEED**

a. Press one "P2" button until motor jog x1 and beep x1.

b. Press "Down" button until motor jog x1 and beep x1.

c. Once more, press "Down" button until motor jog x2 and beep x1.

Action on Wall Switch

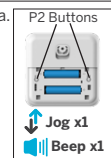

Motor Response

Action on Wall Switch

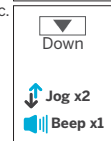

Motor Response

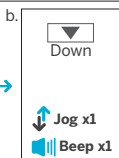

\*If the motor has no response, it already has a Maximum or Minimum speed.