

LEVOLOR®

Roller Shades–Fabric/Solar/Banded

Persianas enrollables: de tela/solares/en banda

Stores à enroulement automatique – en tissu/solaires/à bandes

INSTALLATION • OPERATION • CARE
INSTALACIÓN • FUNCIONAMIENTO • CUIDADO
INSTALLATION • UTILISATION • ENTRETIEN



Motorized Control Lift

Elevación con control motorizado

Commande de levage motorisée

CONTENTS

Window and Shade Terminology

Mounting Types and Window Terminology 3

Getting Started

Installation Overview 3

Components Included 4

Tools and Fasteners You May Need 5

Installation

Inside Mount 6–7

Outside Mount 8–9

Operation

Remote Operation 10

Battery Charging 10

Uninstall

Removing the Shade 10

Cleaning and Care

..... 11

Additional Information and Support

Warranty 11

Customer Service Support 11

CANADIAN RESIDENTS ONLY

- Control operation systems vary by country. Call 1-866-937-1875 for more information.
- For all safety, related inquiries, call 1-866-662-0666 or visit www.canada.ca, search "blind cords".
- These instructions include references to some product features and operating capabilities that may not be available in Canada.



WARNING STRANGULATION HAZARD —

Young children can be strangled by cords. Immediately remove this product if a cord longer than 22 cm or a loop exceeding 44 cm around becomes accessible.



WARNING: Keep all small parts, components and packaging away from children as they pose a potential choking hazard which may result in serious injury or death. Please reference all warning tags and labels in the instructions and on the shade.

WINDOW AND SHADE TERMINOLOGY

Thank you for purchasing LEVOLOR® Roller Shades. With proper installation, operation, and care, your new roller shade will provide years of beauty and performance. Please thoroughly review this instruction booklet before beginning installation.

MOUNTING TYPES AND WINDOW TERMINOLOGY

If the installation brackets are mounted correctly, the rest of the installation process follows easily. To prepare for this important first step, review the mounting types and basic window terminology illustrated below.

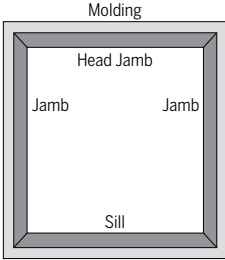

Window Components Terminology

- Collectively, the sill and jambs are called the "window casement" or "frame".

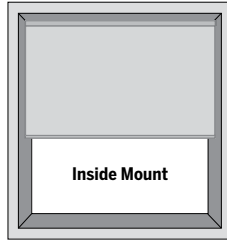

Inside Mount

- Shade fits within window opening.
- Great for windows with beautiful trim.

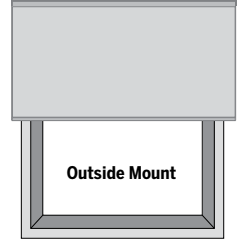

Outside Mount

- Shade mounts outside window opening.
- Increased light control and privacy.

INSTALLATION OVERVIEW

- Confirm that the headrail and shade are the proper width and length.
- If installing several sets of shades, be sure to match them with the appropriate window.
- Check the installation surface to ensure that you have suitable fasteners and tools.
- Lay out and organize all parts and components.

Installation Brackets

Your order will include the correct number of installation brackets for your shade width, as shown in the table below

Shade Width (inches)	Number of Brackets per Shade
Up to 36	3
36 to 54	4
54 to 72	5
72 to 108	6
108 to 144	7

GETTING STARTED

COMPONENTS INCLUDED IN THE BOX

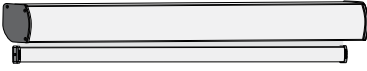

Roller Shade – Fabric/Solar



Roller Shade – Banded



Hex Head Screws
(2 per Bracket)

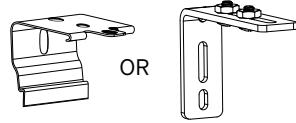

Mounting Brackets
(L bracket only required on outside mount)

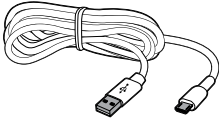

Micro-USB
Charging Cable

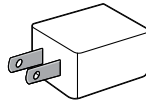

Power Adapter

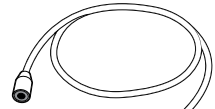

Magnetic
Charging Adapter

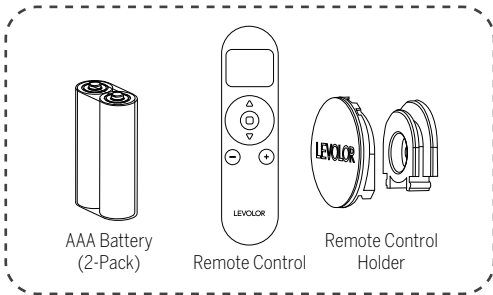

AAA Battery
(2-Pack)

Remote Control

Remote Control
Holder

Remote Control Kit
(optional)



Hub
(optional)

TOOLS AND FASTENERS YOU MAY NEED (not included)

The tools you will need for installing your shade will vary, depending on the installation surface and mounting bracket type.

Tools typically used for installation include:

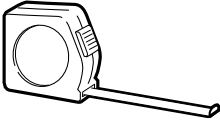

Metal Tape Measure

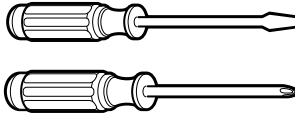

Screwdrivers
(both flat and Phillips head)



1/4" and 3/8" Nutdrivers



Safety Glasses

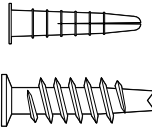

Drywall Anchors



Pencil

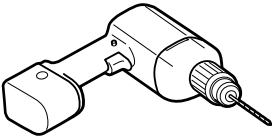

Drill with Bits



Level

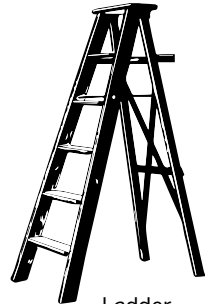

Ladder



CAUTION: Use drywall anchors when mounting into drywall (not provided). Failure to properly anchor shade could cause shade to fall possibly resulting in injury.

INSTALLATION

BEFORE YOU BEGIN

PAIR SHADE BEFORE INSTALLING

REMOTE CONTROL

- Use the **-** and **+** buttons to select the channel to pair to.
- Press and hold the programming button on the window covering for about 2 seconds until the shade jogs and/or beeps once.
- In the next 10 seconds, press and hold the **■** on the remote until the shade jogs twice and/or beeps three times.

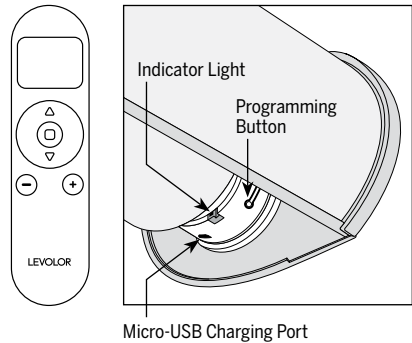

USING THE INMOTION APP

- If you purchased a hub, download the LEVOLOR InMotion™ app to get started.
- Shade can be directly paired to app, but it is recommended to pair to remote first.

INSIDE MOUNT (IM)

STEP 1: MARKING THE BRACKET LOCATIONS

IMPORTANT: Before marking bracket locations, ensure that your bracket placement will not interfere with any components inside the headrail.

- Verify that the window casing has a minimum depth of 2 $\frac{1}{8}$ " which allows for a partially recessed headrail mount.
- If flush mount (fully recessed mount) is desired, a minimum mounting depth of 3 $\frac{5}{8}$ " is required, depending on cassette size.
- Mark approximately 3" from each jamb for bracket location.
- Mark screw locations for each end bracket, 2 holes per bracket.
- If more than three installation brackets come with your order, space additional bracket(s) evenly between the two end brackets, no more than 30" apart.

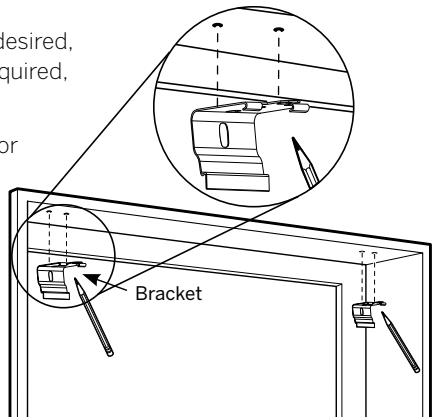

INSIDE MOUNT (IM)

STEP 2: INSTALLING THE BRACKETS

- Pre-drill screw holes using a $\frac{1}{16}$ " drill bit.
 - If installing brackets into wood, use supplied screws.
 - If installing into drywall, use anchors in combination with supplied screws.
- Screw in brackets at marked locations.
- Ensure all brackets are square with each other.

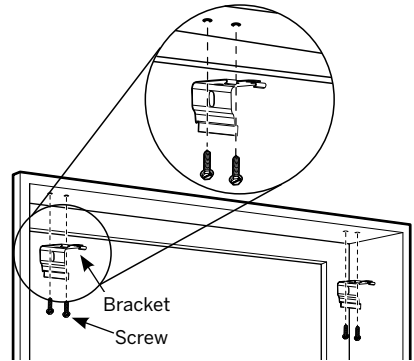

STEP 3: INSTALLING THE SHADE

- Hook the top, middle rib of the cassette valance onto all of the bracket hooks.
- Rotate the back of the cassette valance firmly upwards and toward the window until the groove at the bracket snaps into place.

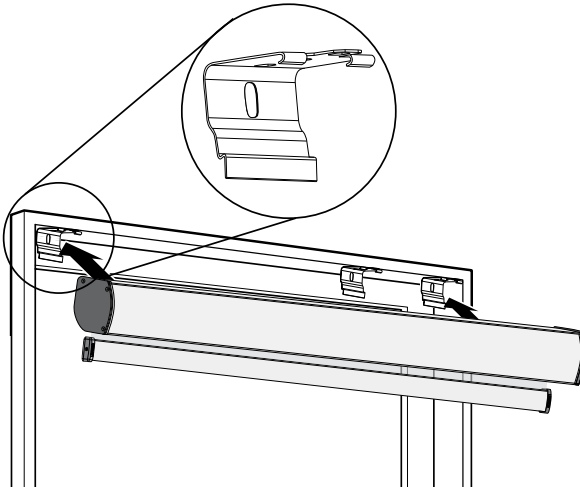

CAUTION: Be sure the brackets are properly engaged before operating the shade. Failure to do so may result in the shade falling and possible injury.

INSTALLATION

BEFORE YOU BEGIN

PAIR SHADE BEFORE INSTALLING

REMOTE CONTROL

- Use the **-** and **+** buttons to select the channel to pair to.
- Press and hold the programming button on the window covering for about 2 seconds until the shade jogs and/or beeps once.
- In the next 10 seconds, press and hold the **■** on the remote until the shade jogs twice and/or beeps three times.

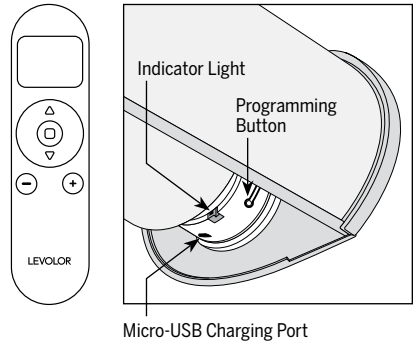

USING THE INMOTION APP

- If you purchased a hub, download the LEVOLOR InMotion™ app to get started.
- Shade can be directly paired to app, but it is recommended to pair to remote first.

OUTSIDE MOUNT (OM)

STEP 1: MARKING THE BRACKET LOCATIONS

IMPORTANT: The brackets must be flush against a flat mounting surface. Do NOT mount brackets on curved molding.

- Center the shade over the window opening at the desired height.
- Mark screw locations for each L bracket approximately 3" from end of cassette, 2 holes per bracket.
 - Use a level to ensure all brackets are aligned.
- If more than three installation brackets come with your order, space additional bracket(s) evenly between the two end brackets, no more than 30" apart.

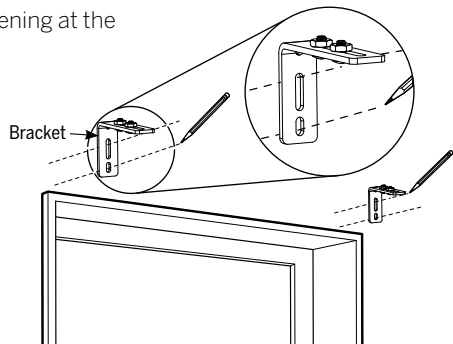

OUTSIDE MOUNT (OM)

STEP 2: INSTALLING THE BRACKETS

- Pre-drill screw holes using a $\frac{1}{16}$ " drill bit, using pencil marks as a guide.
 - If installing brackets into wood, use supplied screws.
 - If installing into drywall, use anchors in combination with supplied screws.
- Screw in L brackets at marked locations, 2 screws per bracket.
- Ensure all L brackets are square with each other.
- Attach cassette mounting bracket to L bracket using screws and hex nuts.
 - Make sure the release tab is always mounted on the bottom.

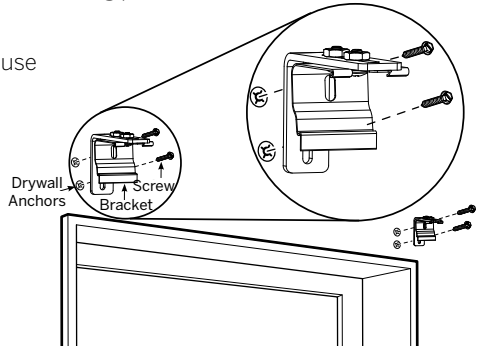

STEP 3: INSTALLING THE SHADE

- Hook the top, middle rib of the cassette valance onto all of the bracket hooks.
- Rotate the back of the cassette valance firmly upwards and toward the window until the groove at the bracket snaps into place.

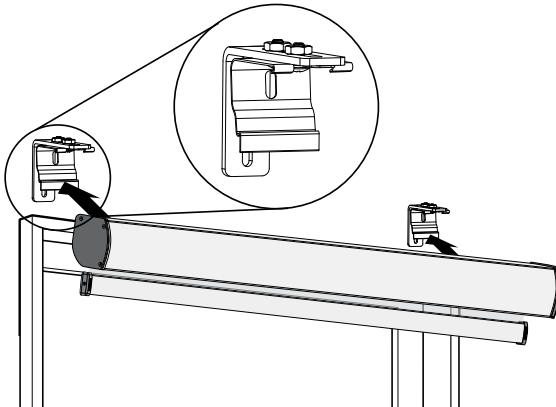

CAUTION: Be sure the brackets are properly engaged before operating the shade. Failure to do so may result in the shade falling and possible injury.

OPERATION

REMOTE OPERATION

- Scan for remote guide.



BATTERY CHARGING

- Rechargeable battery is integrated into shade headrail.
- Use the standard micro-USB cable or attach the magnetic charging adapter to the 5V power adapter for simple and easy charging.
- Indicator light battery status:
 - Low (red flash)
 - Charging (green flash)
 - Charged (green solid)
- It is recommended to fully charge shade prior to first use.

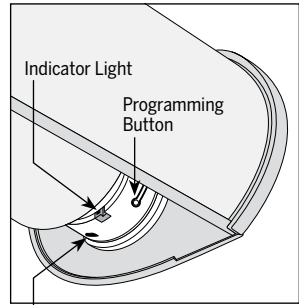

Micro-USB Charging Port

UNINSTALL

REMOVING THE SHADE

- Fully raise the shade.
- While holding the headrail, use a flathead screwdriver to engage the release tab on the bottom of all of the installation brackets.
- Rotate the bottom of the shade away from the window, fully releasing it from the brackets.

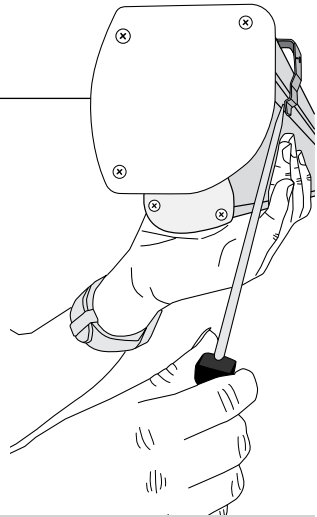

CAUTION: Hold shade firmly when removing. Failure to do so may result in the shade falling and possible injury.

CLEANING PROCEDURES

All LEVOLOR Roller Shades have multiple cleaning options.

NOTICE: Avoid contact with window cleaning products. Improper cleaning may void warranty.



DUSTING

Use a feather duster for regular cleaning.



FORCED AIR

Blow away dirt and debris using clean compressed air.



PROFESSIONAL INJECTION/EXTRACTION CLEANING

Call local on-site blind/shade cleaner that injects a cleaning solution into the fabric and extracts the dirty solution at the same time. The service is typically performed at home so you do not need to remove your window treatments.



VACUUMING

Use a low suction vacuum with a brush-type cleaner attachment; stroke lightly over the shade to clean.



SPOT-CLEANING/STAIN REMOVAL AT HOME

Use warm water and a mild soap, like Woolite® or Scotchgard®, if needed. Do not immerse shade in water.

ADDITIONAL INFORMATION

WARRANTY

For complete warranty information visit LEVOLOR.com or call Customer Service at 1-800-LEVOLOR or 1-800-538-6567.

CONTACTING US

To contact LEVOLOR Customer Service regarding any questions or concerns you may have about your new shades, you may reach us at: 1-800-LEVOLOR (9:00 am – 6:00 pm EST)

www.LEVOLOR.com

LEVOLOR®

Roller Shades – Fabric/Solar/Banded

Persianas enrollables: de tela/solares/en banda

Stores à enroulement automatique – en tissu/solaires/à bandes

INSTALLATION • OPERATION • CARE
INSTALACIÓN • FUNCIONAMIENTO • CUIDADO
INSTALLATION • UTILISATION • ENTRETIEN

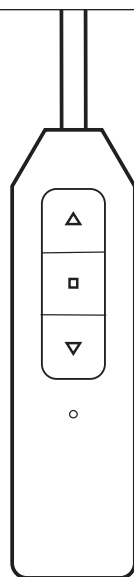
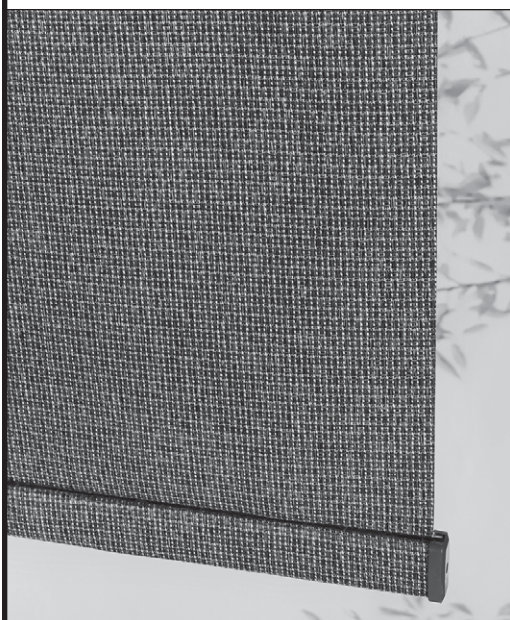

Motorized Wand Lift Control – Cassette Valance

Control motorizado de elevación de la vara:
cenefa en cascada

Commande de levage de baguette motorisée –
Cantonnière à casier

CONTENTS

Window and Shade Terminology

Mounting Types and Window Terminology 3

Getting Started

Installation Overview 3

Components Included 4

Tools and Fasteners You May Need 5

Installation

Inside Mount 6–7

Outside Mount 8–9

Operation

Attach the Wand 10

Operate the Wand 10–12

Charge the Battery 13

Uninstall

Removing the Shade 13

Cleaning and Care

..... 14

Additional Information and Support

Motorized Wand Troubleshooting 15

Warranty 15

Customer Service Support 15

CANADIAN RESIDENTS ONLY

- Control operation systems vary by country. Call 1-866-937-1875 for more information.
- For all safety, related inquiries, call 1-866-662-0666 or visit www.canada.ca, search "blind cords".
- These instructions include references to some product features and operating capabilities that may not be available in Canada.



WARNING STRANGULATION HAZARD —

Young children can be strangled by cords. Immediately remove this product if a cord longer than 22 cm or a loop exceeding 44 cm around becomes accessible.



WARNING: Keep all small parts, components and packaging away from children as they pose a potential choking hazard which may result in serious injury or death. Please reference all warning tags and labels in the instructions and on the shade.

WINDOW AND SHADE TERMINOLOGY

Thank you for purchasing LEVOLOR® Roller Shades. With proper installation, operation, and care, your new roller shade will provide years of beauty and performance. Please thoroughly review this instruction booklet before beginning installation.

MOUNTING TYPES AND WINDOW TERMINOLOGY

If the installation brackets are mounted correctly, the rest of the installation process follows easily. To prepare for this important first step, review the mounting types and basic window terminology illustrated below.

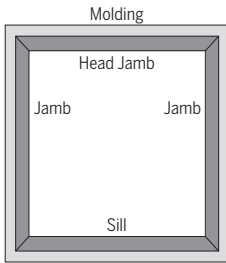

Window Components Terminology

- Collectively, the sill and jambs are called the "window casement" or "frame".

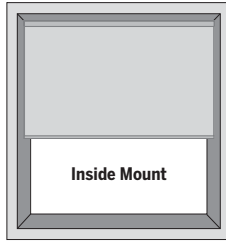

Inside Mount

- Shade fits within window opening.
- Great for windows with beautiful trim.

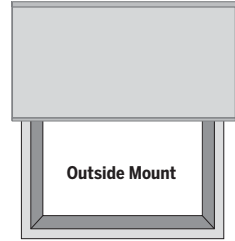

Outside Mount

- Shade mounts outside window opening.
- Increased light control and privacy.

INSTALLATION OVERVIEW

- Confirm that the headrail and shade are the proper width and length.
- If installing several sets of shades, be sure to match them with the appropriate window.
- Check the installation surface to ensure that you have suitable fasteners and tools.
- Lay out and organize all parts and components.

Installation Brackets

Your order will include the correct number of installation brackets for your shade width, as shown in the table below

Shade Width (inches)	Number of Brackets per Shade
Up to 36	3
36 to 54	4
54 to 72	5
72 to 108	6
108 to 144	7

GETTING STARTED

COMPONENTS INCLUDED IN THE BOX

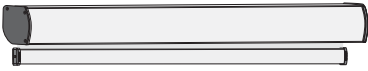

Roller Shade – Fabric/Solar



Roller Shade – Banded



Hex Head Screws
(2 per Bracket)

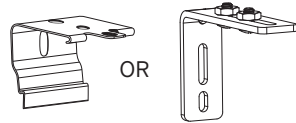

Mounting Brackets
(L bracket only required on outside mount)

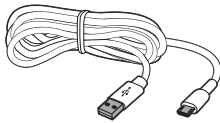

Micro-USB
Charging Cable

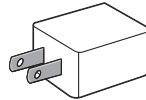

Power Adapter

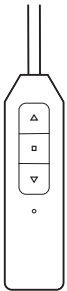

Wand
(Included)

TOOLS AND FASTENERS YOU MAY NEED (not included)

The tools you will need for installing your shade will vary, depending on the installation surface and mounting bracket type.

Tools typically used for installation include:

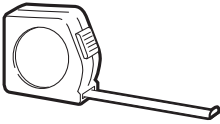

Metal Tape Measure

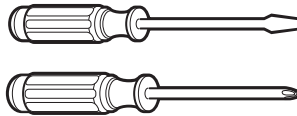

Screwdrivers
(both flat and Phillips head)



1/4" and 3/8" Nutdrivers



Safety Glasses

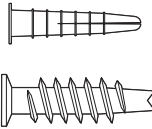

Drywall Anchors



Pencil

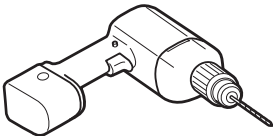

Drill with Bits



Level



Ladder



CAUTION: Use drywall anchors when mounting into drywall (not provided). Failure to properly anchor shade could cause shade to fall possibly resulting in injury.

INSTALLATION

INSIDE MOUNT (IM)

STEP 1: MARKING THE BRACKET LOCATIONS

IMPORTANT: Before marking bracket locations, ensure that your bracket placement will not interfere with any components inside the headrail.

- Verify that the window casing has a minimum depth of 2 1/8" which allows for a partially recessed headrail mount.
- If flush mount (fully recessed mount) is desired, a minimum mounting depth of 3 5/8" is required, depending on cassette size.
- Mark approximately 3" from each jamb for bracket location.
- Mark screw locations for each end bracket, 2 holes per bracket.
- If more than three installation brackets come with your order, space additional bracket(s) evenly between the two end brackets, no more than 30" apart.

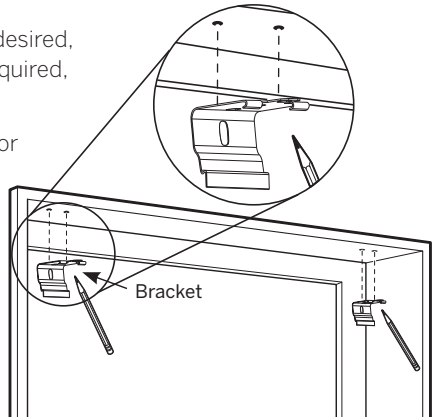

STEP 2: INSTALLING THE BRACKETS

- Pre-drill screw holes using a 1/16" drill bit.
 - If installing brackets into wood, use supplied screws.
 - If installing into drywall, use anchors in combination with supplied screws.
- Screw in brackets at marked locations.
- Ensure all brackets are square with each other.

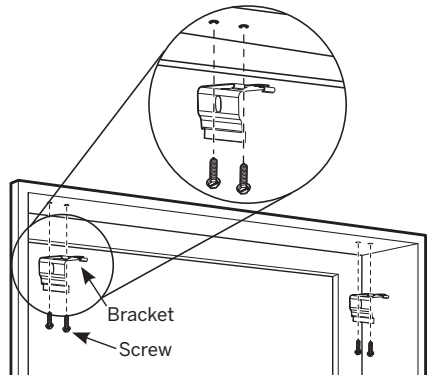

INSIDE MOUNT (IM)

STEP 3: INSTALLING THE SHADE

- Hook the top, middle rib of the cassette valance onto all of the bracket hooks.
- Rotate the back of the cassette valance firmly upwards and toward the window until the groove at the bracket snaps into place.

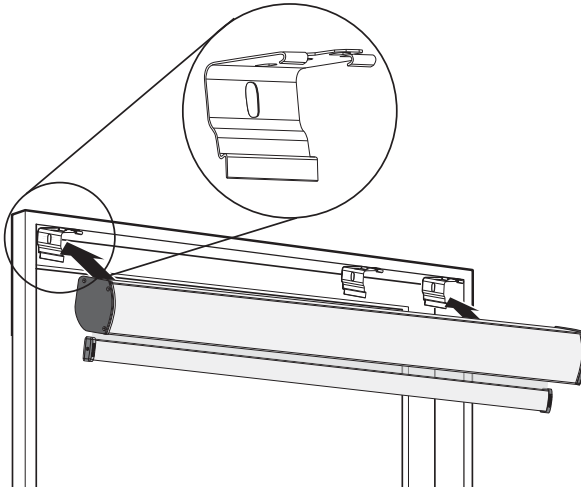

CAUTION: Be sure the brackets are properly engaged before operating the shade. Failure to do so may result in the shade falling and possible injury.

INSTALLATION

OUTSIDE MOUNT (OM)

STEP 1: MARKING THE BRACKET LOCATIONS

IMPORTANT: The brackets must be flush against a flat mounting surface. Do NOT mount brackets on curved molding.

- Center the shade over the window opening at the desired height.
- Mark screw locations for each L bracket approximately 3" from end of cassette, 2 holes per bracket.
 - Use a level to ensure all brackets are aligned.
- If more than three installation brackets come with your order, space additional bracket(s) evenly between the two end brackets, no more than 30" apart.

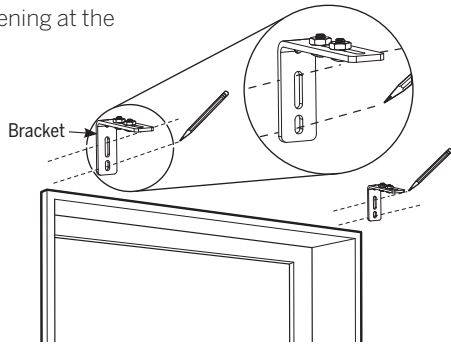

STEP 2: INSTALLING THE BRACKETS

- Pre-drill screw holes using a 1/16" drill bit, using pencil marks as a guide.
 - If installing brackets into wood, use supplied screws.
 - If installing into drywall, use anchors in combination with supplied screws.
- Screw in L brackets at marked locations, 2 screws per bracket.
- Ensure all L brackets are square with each other.
- Attach cassette mounting bracket to L bracket using screws and hex nuts.
 - Make sure the release tab is always mounted on the bottom.

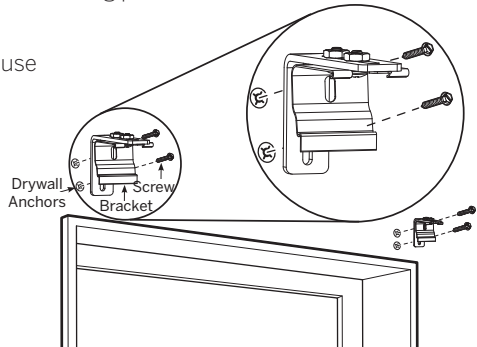

OUTSIDE MOUNT (OM)

STEP 3: INSTALLING THE SHADE

- Hook the top, middle rib of the cassette valance onto all of the bracket hooks.
- Rotate the back of the cassette valance firmly upwards and toward the window until the groove at the bracket snaps into place.

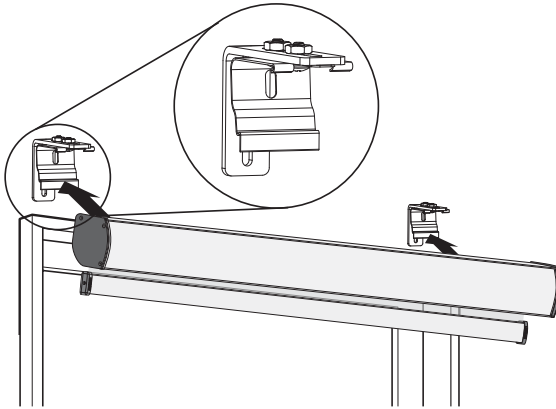

CAUTION: Be sure the brackets are properly engaged before operating the shade. Failure to do so may result in the shade falling and possible injury.

OPERATION

ATTACH THE WAND

- With the wand control buttons facing you, attach the top of the wand on the metal hook support **(1)** on the motor control side, then connect the cable into the motor head **(2)**.

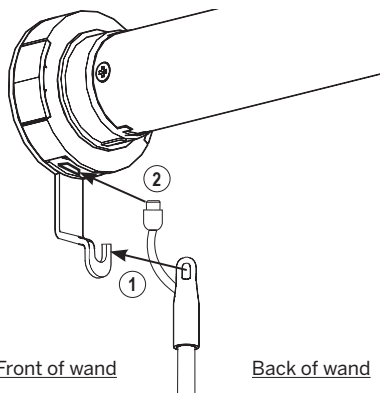

OPERATE THE WAND

Roller Shades Mode:

- Press the **DOWN** or **UP** button to lower or raise the shade. Press the **STOP** to stop the shade at the desired position.

Banded Shades Mode:

- Tapping the **UP** or **DOWN** button for less than 2 seconds will move the shade in short steps.
- Holding the **UP** or **DOWN** button down for more than 2 seconds before releasing will operate the shade at the standard speed.
- Press the **STOP** button to stop the shade at the desired position.

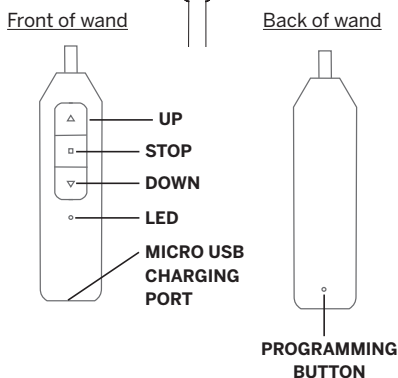

Set a Favorite Position

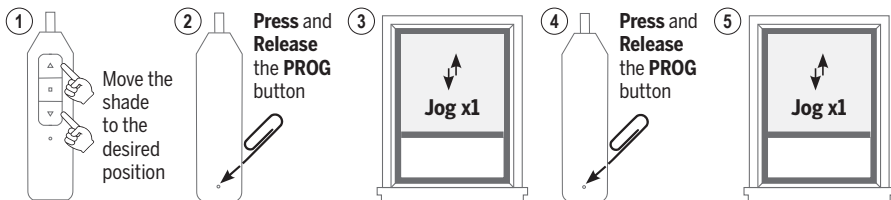

IMPORTANT: Once the favorite position is set, the shade will always stop at the designed favorite position when passing by it. Click 2 x Up or Down button, the shade will go to set Top or Bottom Limit.

Remove a Favorite Position

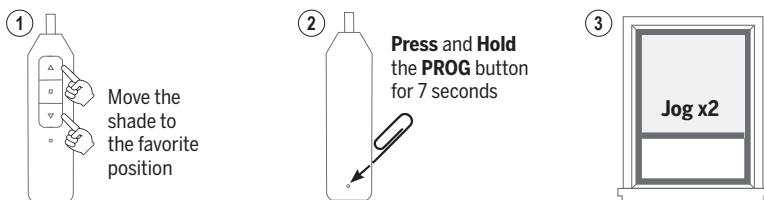

ADVANCED PROGRAMMING

IMPORTANT: Damage to shade may occur when operating the motor prior to setting limits. Attention should be given.

Switch Between Roller and Banded Mode

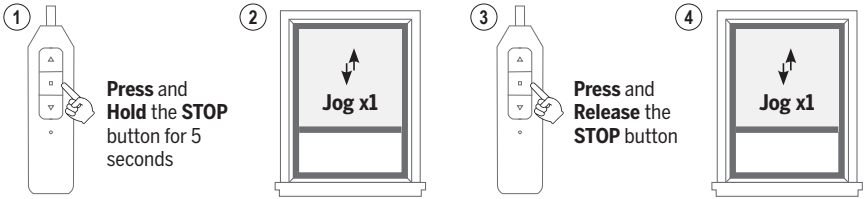

Adjust the Top and/or Bottom Limit

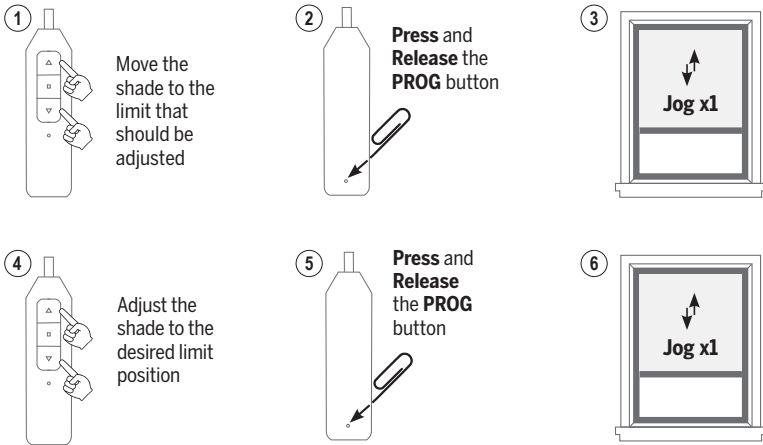

Factory Motor Reset

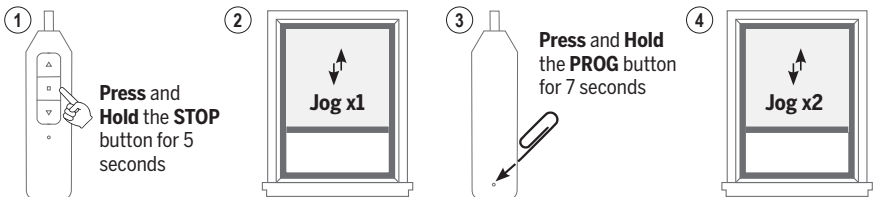

IMPORTANT: All limits will be erased. The motor direction will return to default and may need to be adjusted.

OPERATION

Reverse Up and Down Commands (Only if Necessary)

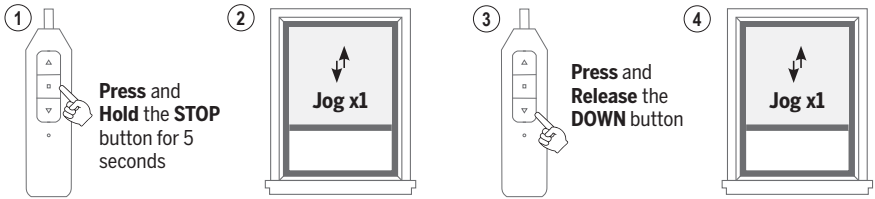

Set Upper and Lower Limits (Only After Factory Motor Reset)

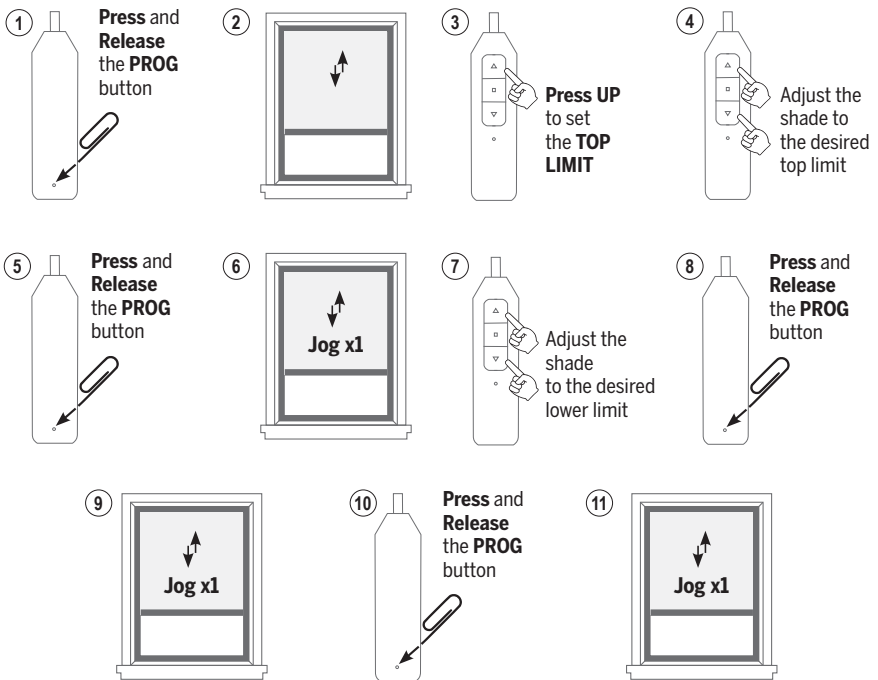

CHARGE THE BATTERY

Roller Shades Mode:

- When the shade begins to operate slower than normal or only beeps when you attempt to operate, it is time to charge the battery.
- To Charge, connect a standard micro USB cable into the bottom of the wand (A) and into USB 5V/2A (max) power supply. A red LED on the wand indicates that the battery is charging. To fully charge the batteries, allow the batteries to charge for at least 1 hour after the LED on the wand turns green.

Note: A typical charge cycle can take between 4-6 hours.

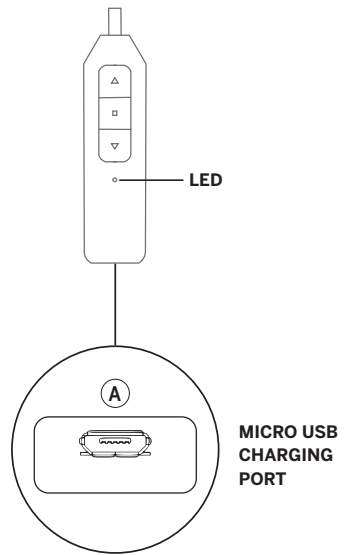

UNINSTALL

REMOVING THE SHADE

- Fully raise the shade.
- While holding the headrail, use a flathead screwdriver to engage the release tab on the bottom of all of the installation brackets.
- Rotate the bottom of the shade away from the window, fully releasing it from the brackets.

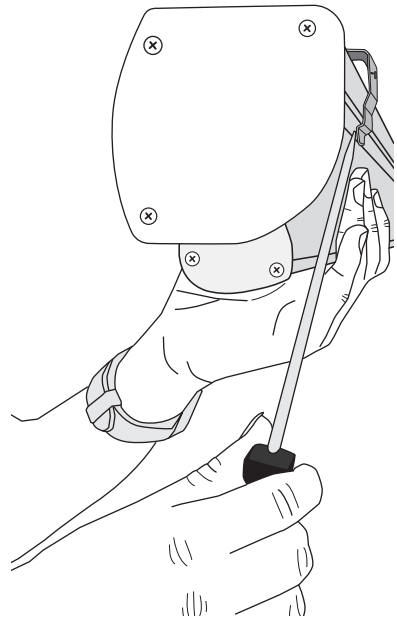

CAUTION: Hold shade firmly when removing. Failure to do so may result in the shade falling and possible injury.

CLEANING AND CARE

CLEANING PROCEDURES

All LEVOLOR Roller Shades have multiple cleaning options.

NOTICE: Avoid contact with window cleaning products. Improper cleaning may void warranty.



DUSTING

Use a feather duster for regular cleaning.



FORCED AIR

Blow away dirt and debris using clean compressed air.



PROFESSIONAL INJECTION/EXTRACTION CLEANING

Call local on-site blind/shade cleaner that injects a cleaning solution into the fabric and extracts the dirty solution at the same time. The service is typically performed at home so you do not need to remove your window treatments.



VACUUMING

Use a low suction vacuum with a brush-type cleaner attachment; stroke lightly over the shade to clean.



SPOT-CLEANING/STAIN REMOVAL AT HOME

Use warm water and a mild soap, like Woolite® or Scotchgard®, if needed. Do not immerse shade in water.

MOTORIZED WAND TROUBLESHOOTING

Problem	The shade is not responding
Solution	Built-in battery is depleted. Recharge with compatible USB 5V/2A (max) adapter and a micro USB cable. Wand is not fully connected to the motor. Check the connection between the wand and the motor.
Problem	The shade moves the opposite direction on the control buttons
Solution	The motor direction is reversed. See details under “Reverse Up and Down Commands”.
Problem	The shade stops by itself before it reaches the top or bottom limit
Solution	A favorite position was set. See details under “Remove a Favorite Position”
Problem	The shade only moves in small steps after pressing the button
Solution	The shade is operating on Banded mode. Switch to Roller mode by following the steps under “Switch between Roller and Banded Mode” The shade has no limit set. See details under “Set Upper and Lower Limits”

WARRANTY

For complete warranty information visit LEVOLOR.com or call Customer Service at 1-800-LEVOLOR or 1-800-538-6567.

CONTACTING US

To contact LEVOLOR Customer Service regarding any questions or concerns you may have about your new shades, you may reach us at: 1-800-LEVOLOR (8:30 am – 6:30 pm EST)

www.LEVOLOR.com

ADDITIONAL PARTS AND SERVICES

Additional or replacement parts can be ordered, or shades can be repaired or restrung through our repair center. Please contact LEVOLOR customer service through www.LEVOLOR.com for a return authorization number.

LEVOLOR®

Roller Shades – Fabric/Solar

Persianas en rollo: tela/solar

Stores à enroulement automatique – en tissu/solaire

INSTALLATION • OPERATION • CARE
INSTALACIÓN • FUNCIONAMIENTO • CUIDADO
INSTALLATION • UTILISATION • ENTRETIEN

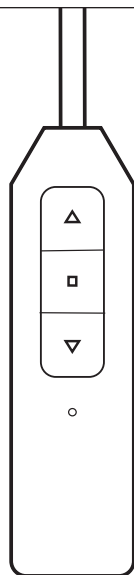
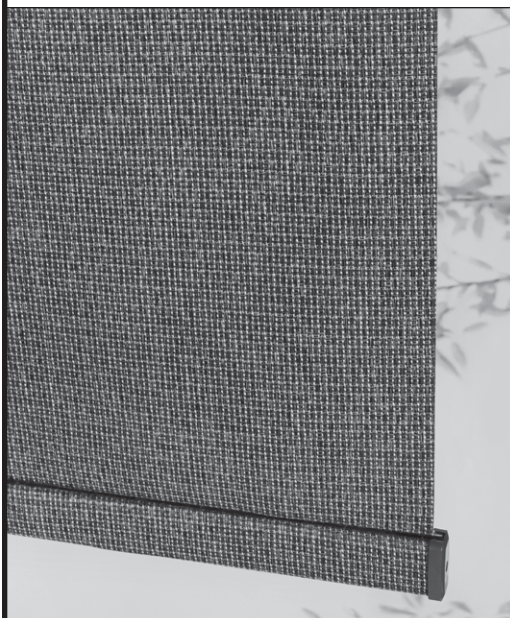

Motorized Wand Lift Control – Open Roll and Standard Valance

Control de elevación de la vara motorizada:
rollo abierto y cenefa estándar

Commande de levage de baguette motorisée –
enroulement ouvert et cantonnière standard

CONTENTS

Window and Shade Terminology

Mounting Types and Window Terminology 3

Getting Started

Installation Overview 3

Components Included 4

Tools and Fasteners You May Need 5

Installation

Inside Mount 6–7

Outside Mount 8–10

Operation

Attach the Wand 11

Operate the Wand 11–13

Charge the Battery 14

Installation – Additional Components

Hold-Down Brackets (Optional) 14

Uninstall

Removing the Shade 15

Cleaning and Care

Additional Information and Support

Motorized Wand Troubleshooting 16

Warranty 16

Customer Service Support 16

CANADIAN RESIDENTS ONLY

- Control operation systems vary by country. Call 1-866-937-1875 for more information.
- For all safety, related inquiries, call 1-866-662-0666 or visit www.canada.ca, search "blind cords".
- These instructions include references to some product features and operating capabilities that may not be available in Canada.



WARNING STRANGULATION HAZARD –

Young children can be strangled by cords. Immediately remove this product if a cord longer than 22 cm or a loop exceeding 44 cm around becomes accessible.



WARNING: Keep all small parts, components and packaging away from children as they pose a potential choking hazard which may result in serious injury or death. Please reference all warning tags and labels in the instructions and on the shade.

WINDOW AND SHADE TERMINOLOGY

Thank you for purchasing LEVOLOR® Roller Shades. With proper installation, operation, and care, your new roller shade will provide years of beauty and performance. Please thoroughly review this instruction booklet before beginning installation.

MOUNTING TYPES AND WINDOW TERMINOLOGY

If the installation brackets are mounted correctly, the rest of the installation process follows easily. To prepare for this important first step, review the mounting types and basic window terminology illustrated below.

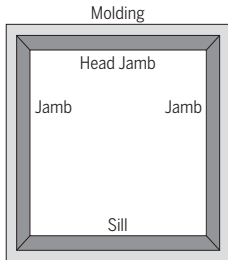

Window Components Terminology

- Collectively, the sill and jamba are called the "window casement" or "frame".

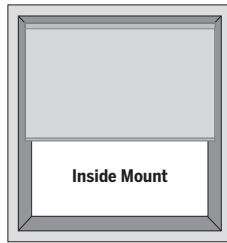

Inside Mount

- Shade fits within window opening.
- Great for windows with beautiful trim.

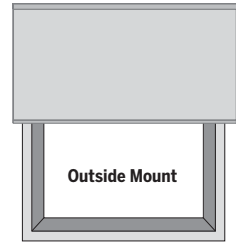

Outside Mount

- Shade mounts outside window opening.
- Increased light control and privacy.

INSTALLATION OVERVIEW

- **Leaving the shade rolled up completely will ease installation.**
- Confirm that the headrail and shade are the proper width and length.
- If installing several sets of shades, be sure to match them with the appropriate window.
- Check the installation surface to ensure that you have suitable fasteners and tools.
- Lay out and organize all parts and components.
- Proper shade direction during installation:
 - For Traditional Roller Shades, fabric will hang off the back of the shade, closest to the window.
 - For Optional Reverse Roller Shades, fabric will hang off the front of the shade.

GETTING STARTED

COMPONENTS INCLUDED IN THE BOX

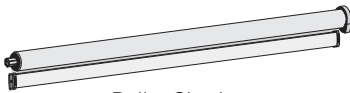

Roller Shade

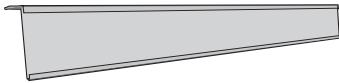

Valance (Optional)

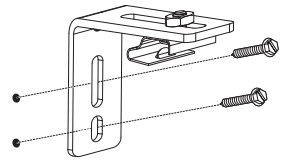

Mounting Brackets-Valance
(outside mount only)

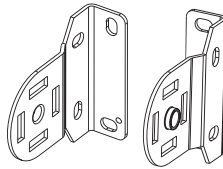

Mounting Brackets
(Bracket determined
by shade size)

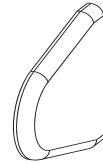

2 Open Roll End Caps

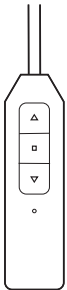

Wand



Screws
(2 per Bracket)

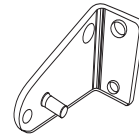

Hold-Down Brackets
(optional)

- Shade and motorized wand
- Mounting Brackets, shade and valance
- Installation Hardware

Optional items will be included, if selected at time of shade order.

TOOLS AND FASTENERS YOU MAY NEED (not included)

The tools you will need for installing your shade will vary, depending on the installation surface and mounting bracket type.

Tools typically used for installation include:

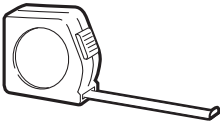

Metal Tape Measure

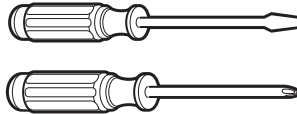

Screwdrivers
(both flat and Phillips head)



1/4" and 3/8" Nutdrivers



Safety Glasses

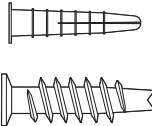

Drywall Anchors



Pencil

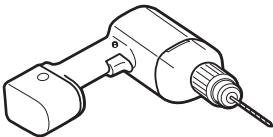

Drill with Bits



Level



Ladder



CAUTION: Use drywall anchors when mounting into drywall. (Not provided.) Failure to properly anchor shade could cause shade to fall possibly resulting in injury.

INSTALLATION

INSIDE MOUNT (IM)

STEP 1: MARKING THE BRACKET LOCATIONS

IMPORTANT: Before marking bracket locations, ensure that your bracket placement will not interfere with any components inside the headrail.

- Verify that your window casing has a minimum depth of 1 ½" which allows for a partially recessed headrail mount.
- If flush mount (fully recessed mount) is desired, a minimum mounting depth of 3 ¼" is required.
- Place brackets on inside surface of valance, flush with the edge at either end.
- Mark screw locations for each end bracket onto the valance, 2 holes per bracket.

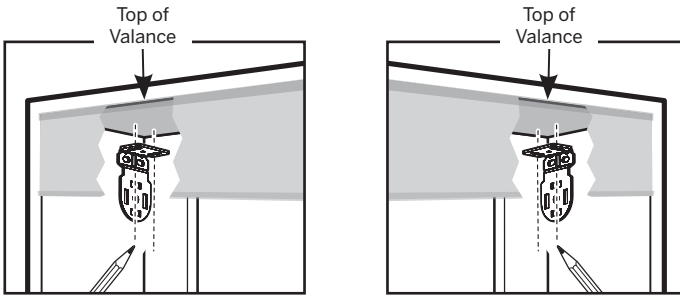

STEP 2: INSTALLING THE BRACKETS

- Put the valance in the window frame and using the marks, pre-drill screw holes through the valance into the frame.
 - If installing brackets into wood, use supplied screws.
 - If installing into drywall, use anchors in combination with supplied screws.
- Screw in brackets through valance into the window frame at marked locations, 2 screws per bracket.
- Ensure all brackets are square with each other.

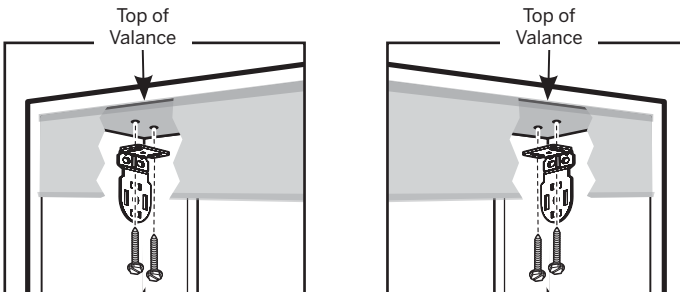

INSIDE MOUNT (IM)

STEP 3: INSTALLING THE SHADE

- Place the spring loaded pin end into the round hole of the bracket.
- On the other side of shade, compress the spring loaded end plug and secure into opposite bracket.
- Once the two hooks are through the slots, gently pull downward on the motor until the hooks have locked securely to the bracket.
 - The reset button of the motor should be facing down.

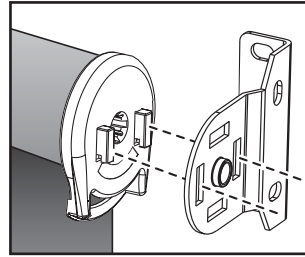
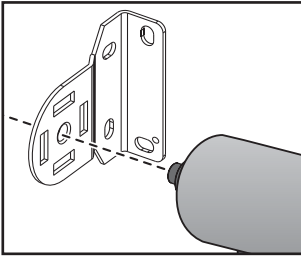

CAUTION: Be sure the brackets are properly engaged before operating the shade. Failure to do so may result in the shade falling and possible injury.

STEP 4: INSTALL THE END CAPS

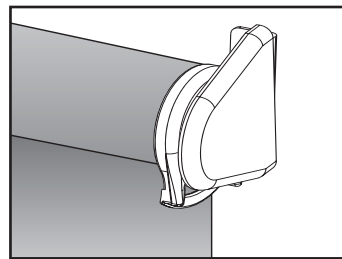
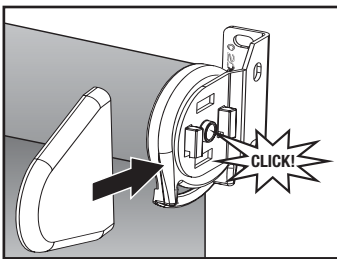

INSTALLATION

OUTSIDE MOUNT (OM)

STEP 1: MARKING THE BRACKET LOCATIONS

IMPORTANT: The brackets must be flush against a flat mounting surface. Do NOT mount brackets on curved molding.

- Center the headrail over the window opening at the desired height.
 - Minimum 1 3/4" mounting surface height required.
- Mark screw locations for each end bracket, 2 holes per bracket.
 - Use a level to ensure all brackets are aligned.

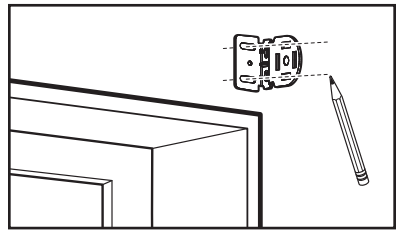
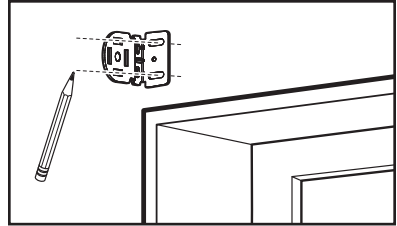

STEP 2: INSTALLING THE SHADE BRACKETS

- Pre-drill screw holes using a 1/16" drill bit, using pencil marks as a guide.
 - If installing brackets into wood, use supplied screws.
 - If installing into drywall or other, use anchors in combination with supplied screws.
- Screw in brackets at marked locations, 2 screws per bracket.
- Ensure all brackets are square with each other.

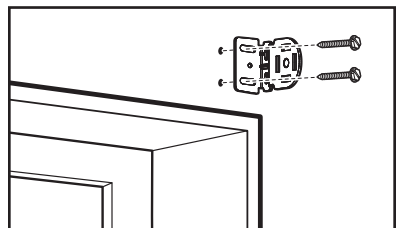
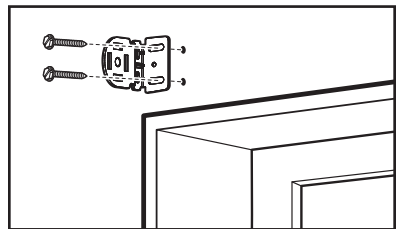

OUTSIDE MOUNT (OM)

STEP 3: INSTALLING VALANCE BRACKETS

- Place valance mounting brackets approximately 3" in from either end bracket for the shade.
- Mark screw locations for a level valance.
- Screw valance brackets into the wall.

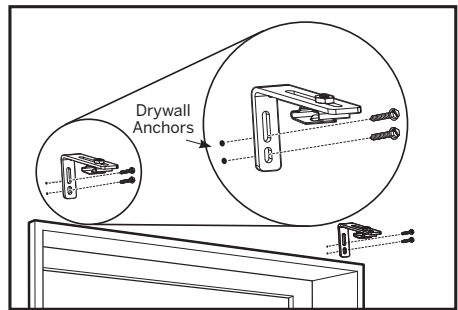
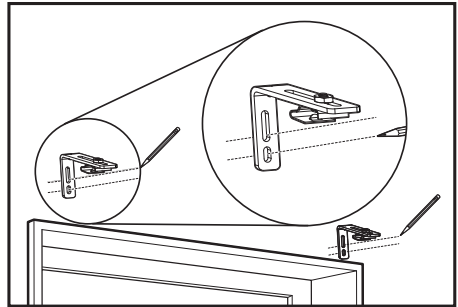

STEP 4: ASSEMBLING VALANCE

- On both ends, attach valance returns.
 - Slide the corner clip onto a return panel.
 - Slide assembled return panel onto the ends of the valance.
- On both ends, attach fabric.
 - Ensuring fabric extends equally over the ends, wrap the fabric around the end of the return panel.
 - Pull tight to remove wrinkles.
 - Remove masking tape and apply to fabric on back of valance.
 - Press the caps into place.

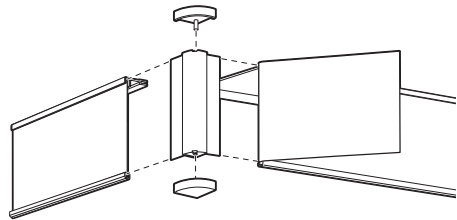

INSTALLATION

STEP 5: INSTALLING THE SHADE AND VALANCE

- Place the spring loaded pin end into the round hole of the bracket.
- On the other side of shade, compress the spring loaded end plug and secure into opposite bracket.
- Once the two hooks are through the slots, gently pull downward on the motor until the hooks have locked securely to the bracket.
 - The reset button of the motor should be facing down.
- Align the valance so the top of the valance can slide into valance bracket.

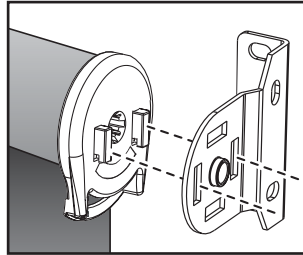
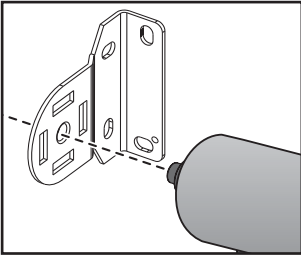

Valance spacing from the wall can be adjusted by loosening hex nut, adjusting, and retightening accordingly.

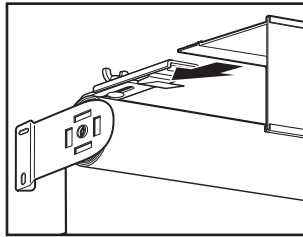

CAUTION: Be sure the bracket and headrail are properly secured before operating the shade. Failure to do so may result in the shade falling and possible injury.

ATTACH THE WAND

- With the wand control buttons facing you, attach the top of the wand on the metal hook support **(1)** on the motor control side, then connect the cable into the motor head **(2)**.

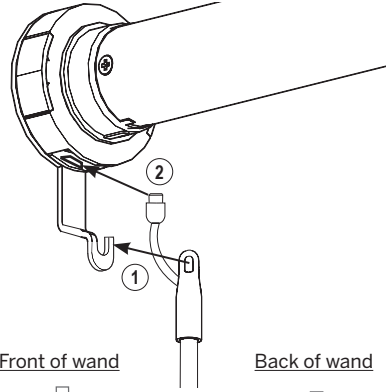

OPERATE THE WAND

Roller Shades Mode:

- Press the **DOWN** or **UP** button to lower or raise the shade. Press the **STOP** to stop the shade at the desired position.

Banded Shades Mode:

- Tapping the **UP** or **DOWN** button for less than 2 seconds will move the shade in short steps.
- Holding the **UP** or **DOWN** button down for more than 2 seconds before releasing will operate the shade at the standard speed.
- Press the **STOP** button to stop the shade at the desired position.

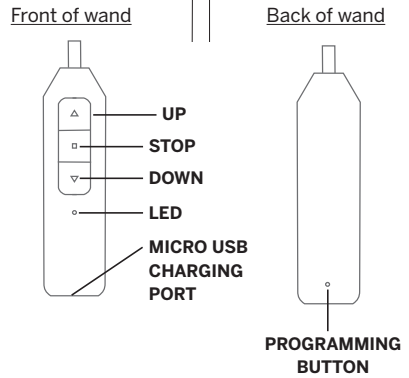

Set a Favorite Position

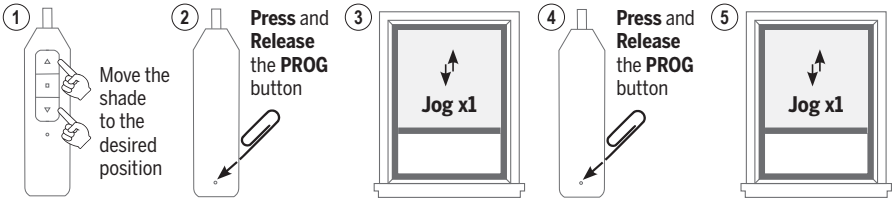

IMPORTANT: Once the favorite position is set, the shade will always stop at the designed favorite position when passing by it. Click 2 x Up or Down button, the shade will go to set Top or Bottom Limit.

Remove a Favorite Position

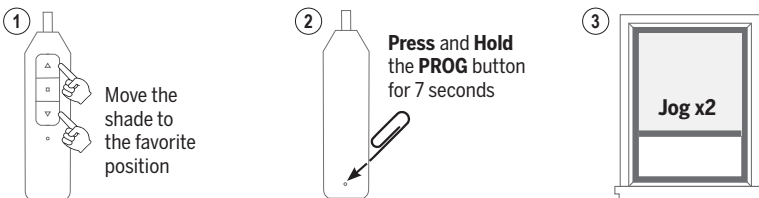

OPERATION

ADVANCED PROGRAMMING

IMPORTANT: Damage to shade may occur when operating the motor prior to setting limits. Attention should be given.

Switch Between Roller and Banded Mode

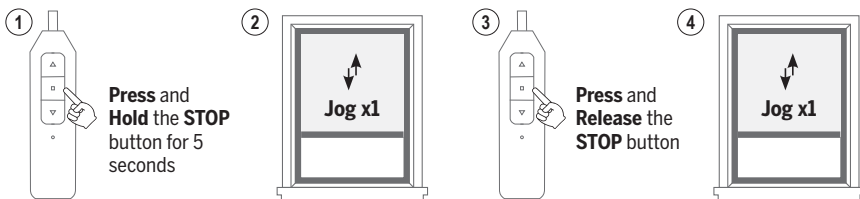

Adjust the Top and/or Bottom Limit

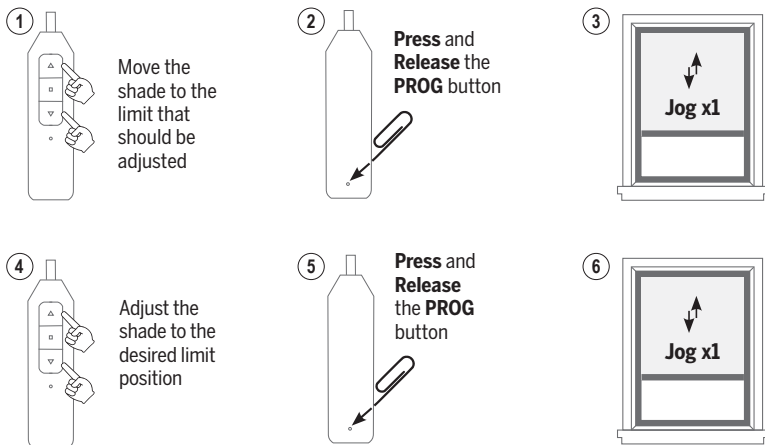

Factory Motor Reset

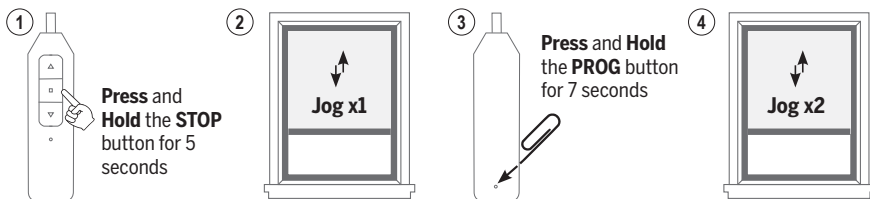

IMPORTANT: All limits will be erased. The motor direction will return to default and may need to be adjusted.

Reverse Up and Down Commands (Only if Necessary)

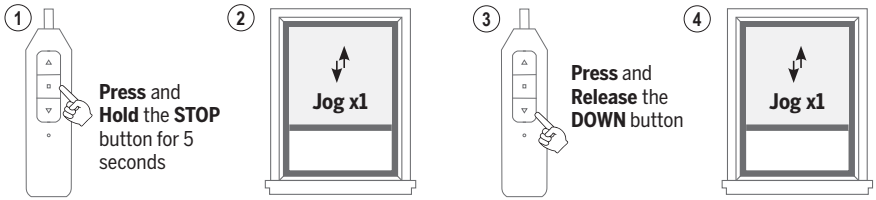

Set Upper and Lower Limits (Only After Factory Motor Reset)

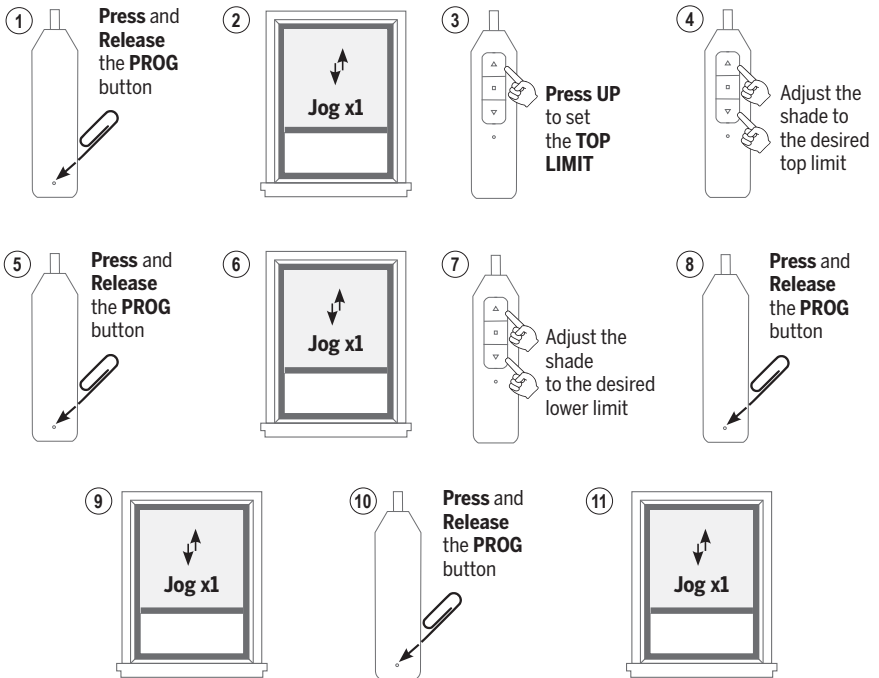

OPERATION

CHARGE THE BATTERY

Roller Shades Mode:

- When the shade begins to operate slower than normal or only beeps when you attempt to operate, it is time to charge the battery.
- To Charge, connect a standard micro USB cable into the bottom of the wand (A) and into USB 5V/2A (max) power supply. A red LED on the wand indicates that the battery is charging. To fully charge the batteries, allow the batteries to charge for at least 1 hour after the LED on the wand turns green.

Note: A typical charge cycle can take between 4-6 hours.

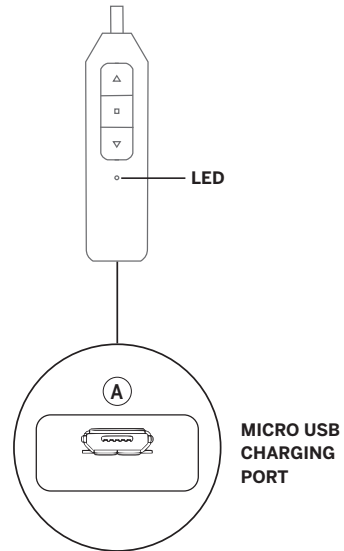

INSTALLATION – ADDITIONAL COMPONENTS

HOLD-DOWN BRACKETS (optional)

- Ideal for doors, hold-down brackets prevent shade from swaying. Assemble as shown to each side of bottom rail.
- Position hold-down brackets against wall/ frame, mark screw hole locations.
- Screw into marked hole locations.

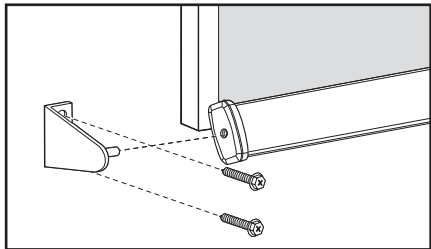

REMOVING THE SHADE

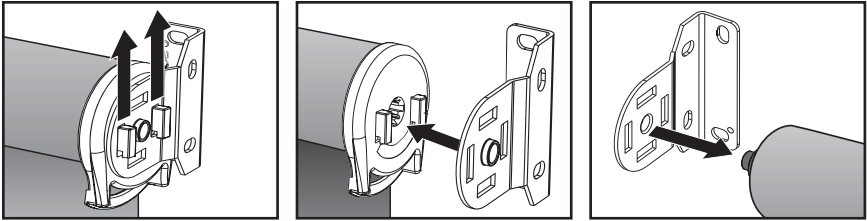

- First, raise the shade. Gently lift up the control unit (hooks end) to disengage, until the hooks touch the top part of the bracket slot.
- Then, slide the roll towards the spring loaded pin end until the hooks are completely out of the bracket slots.
- Lastly, remove the spring loaded pin end from the idler bracket.



CAUTION: Hold shade firmly when removing. Failure to do so may result in the shade falling and possible injury.

CLEANING AND CARE

CLEANING PROCEDURES

All LEVOLOR Roller Shades have multiple cleaning options.

NOTICE: Avoid contact with window cleaning products. Improper cleaning may void warranty.



DUSTING

Use a feather duster for regular cleaning.



FORCED AIR

Blow away dirt and debris using clean compressed air.



PROFESSIONAL INJECTION/EXTRACTION CLEANING

Call local on-site blind/shade cleaner that injects a cleaning solution into the fabric and extracts the dirty solution at the same time. The service is typically performed at home so you do not need to remove your window treatments.



VACUUMING

Use a low suction vacuum with a brush-type cleaner attachment; stroke lightly over the shade to clean.



SPOT-CLEANING/STAIN REMOVAL AT HOME

Use warm water and a mild soap, like Woolite® or Scotchgard®, if needed. Do not immerse shade in water.

ADDITIONAL INFORMATION AND SUPPORT

MOTORIZED WAND TROUBLESHOOTING

- Do not lower the shade past the ordered length. (If it is lowered beyond the limit, the tube underneath the roller will be exposed and fabric damage could occur.)

Problem	The shade is not responding
Solution	Built-in battery is depleted. Recharge with compatible USB 5V/2A (max) adapter and a micro USB cable. Wand is not fully connected to the motor. Check the connection between the wand and the motor.
Problem	The shade moves the opposite direction on the control buttons
Solution	The motor direction is reversed. See details under “Reverse Up and Down Commands”.
Problem	The shade stops by itself before it reaches the top or bottom limit
Solution	A favorite position was set. See details under “Remove a Favorite Position”
Problem	The shade only moves in small steps after pressing the button
Solution	The shade is operating on Banded mode. Switch to Roller mode by following the steps under “Switch between Roller and Banded Mode” The shade has no limit set. See details under “Set Upper and Lower Limits”

WARRANTY

For complete warranty information visit LEVOLOR.com or call Customer Service at 1-800-LEVOLOR or 1-800-538-6567.

CONTACTING US

To contact LEVOLOR Customer Service regarding any questions or concerns you may have about your new shades, you may reach us at: 1-800-LEVOLOR (8:30 am – 6:30 pm EST)

www.LEVOLOR.com

ADDITIONAL PARTS AND SERVICES

Additional or replacement parts can be ordered, or shades can be repaired or restrung through our repair center. Please contact LEVOLOR customer service through www.LEVOLOR.com for a return authorization number.

LEVOLOR®

InMotion™ Motorization



SURFACE MOUNTED WALL SWITCH

PROGRAMMING AND USERS GUIDE

SPECIFICATIONS

Voltage	3V (CR2430)
Radio Frequency	433.92 MHz Bi-directional
Transmitting Power	10 milliwatt
Operating Temperature	14°F to 122°F (-10°C to 50°C)
RF Modulation	FSK
Lock Function	Yes
IP Rating	IP20
Transmission Distance	up to 200m (outdoor)

SAFETY INSTRUCTIONS

1. Do not expose motor to humid, damp, or extreme temperature conditions.
2. Do not drill into motor.
3. Do not cut the antenna. Keep it clear from metal objects.
4. Do not allow children to play with this device.
5. If the power cable or connector is damaged, do not use.
6. Ensure the power cable and antenna are clear and protected from moving parts.
7. Cable routed through walls should be properly isolated.
8. Motor should be mounted in horizontal position only.
9. Before installation, remove unnecessary cords and disable equipment not needed for powered operation.



Do not dispose of in general waste.
Please recycle batteries and damaged electrical products appropriately.

23-0006-050

WALL SWITCH OVERVIEW

Please read prior to installation and use. Save these instructions for future reference.

BUTTON INSTRUCTIONS

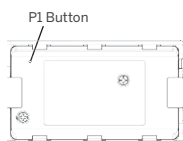
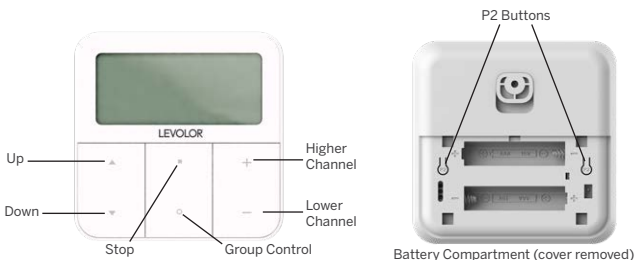

HORIZONTAL BLIND TILT

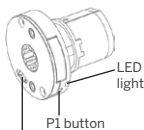

ROLLER / SHEER BANDED

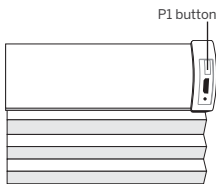

CELLULAR / NATURAL / ROMAN SHADES

REPLACING THE BATTERY

- Gently press down the cover and slide it down.
- Install 2 AAA batteries with the + and - ends facing correctly.
- Slide the cover back onto the backside.

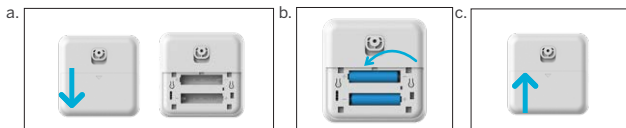

ADVANCED SETTING - DISABLE LIMIT SETTING

a. Press and hold "Stop" button more than 15s. Wall Switch will show "L" (lock).

b. In the next 10s, press one "P2" button on the back of Wall Switch. Wall Switch will show "o", then the Wall Switch switches to "Lock" mode to disable the following commands:

- Change Motor Direction
- Setting the Upper and Lower Limit
- Adjust Limit
- Roller Mode or Sheer Mode

c. Press and hold "Stop" button more than 15s. Wall Switch will show "U" (unlock).

d. In the next 10s, press one "P2" button on the back of Wall Switch. Wall Switch will show "o". The Wall Switch now switches to "Unlock" mode, you can access all control functions.

*This advanced feature is intended to be used after all shade programming is completed. User Mode will prevent accidental or unintended changing of limits.

a. **Action on Wall Switch** **Wall Switch Response**



Wall Switch Response

DECLARATIONS

U.S. Radio Frequency FCC Compliance

This device complies with Part 15 of the FCC Rules. Operation is subject to the following two conditions:

- (1) This device may not cause harmful interference, and
- (2) This device must accept any interference received, including interference that may cause undesired operation.

This equipment has been tested and found to comply with the limits for a Class B digital device, pursuant to Part 15 of the FCC Rules. These limits are designed to provide reasonable protection against harmful interference in a residential installation. This equipment generates, uses, and can radiate radio frequency energy and, if not installed and used in accordance with the instructions, may cause harmful interference to radio communications. However, there is no guarantee that interference will not occur in a particular installation. If this equipment does cause harmful interference to radio or television reception, which can be determined by turning the equipment off and on, the user is encouraged to try to correct the interference by one or more of the following measures:

- Reorient or relocate the receiving antenna.
- Increase the separation between the equipment and receiver.
- Connect the equipment into an outlet on a circuit different from that to which the receiver is connected.
- Consult the dealer or an experienced radio/TV technician for help.

Any Changes or modifications not expressly approved by the party responsible for compliance could void the user's authority to operate the equipment.

ISED RSS Warning:

This device complies with Innovation, Science and Economic Development Canada license-exempt RSS standard(s). Operation is subject to the following two conditions: (1) this device may not cause interference, and (2) this device must accept any interference, including interference that may cause undesired operation of the device.

QUICK INDEX

Settings	Steps
1 Pairing	P1 (hold for 2s) > Stop (hold for 2s)
2 Switch Rotating Direction	Up + Down (hold for 2s)
3 Set Upper/Lower Limits	Upper Limit: Up (hold for 2s) > Up + Stop (hold for 2s) Lower Limit: Down (hold for 2s) > Down + Stop (hold for 2s)
4 Add/Remove Fav. Position	P2 > Stop > Stop
5 Roller/Sheer Mode Switch	Up + Down (hold for 5s) > Stop
6 Adjusting the Limits	Upper: Up + Stop (hold for 5s) > Up or Dn > Up + Stop (hold for 2s) Lower: Dn + Stop (hold for 5s) > Up or Dn > Dn + Stop (hold for 2s)
7 Add/Remove a Remote	P2 (existing) > P2 (existing) > P2 (new)
8 Speed Regulation	Increase Motor Speed: P2 > Up > Up Decrease Motor Speed: P2 > Down > Down

TROUBLESHOOTING

Problem - The motor has no response

Cause	Solution
Battery in motor is depleted	Recharge with compatible AC adaptor and check connection and positioning of solar panel
Insufficient charging from Solar Panel	Check connection and orientation of solar panel.
Wall switch battery is discharged or not installed properly	Replace battery or check placement.
Radio interference/shielding	Ensure wall switch and the antenna on the motor are positioned away from metal objects.
Receiver distance is too far	Move wall switch to a closer position.
Power failure	Check power supply to motor is connected/active.
Incorrect wiring	Check that wiring is connected correctly.

Problem - The Motor beeps 10 times when in use

Cause	Solution
Battery voltage is low/Solar Panel Issue	Recharge with AC adapter or check connection and positioning of solar PV panel

Problem - Cannot program a single motor (multiple motors respond)

Cause	Solution
Multiple Motors are paired to the same	Always reserve a channel for programming. BEST PRACTICE - Provide an extra 15 channel remote in your multi-motor projects for individual control and programming purposes To work on a single motor at a time, place all other motors into sleep mode. Press the "P1" button (about 6 sec) on the motor head until motor jog x2 and beep x2.

CHANNEL OPTIONS

SELECT A CHANNEL

a. Press “-” button on the wall switch to select a lower channel.

b. Press “+” button on the wall switch to select a higher channel.

Action on Wall Switch

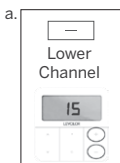

Wall Switch Response

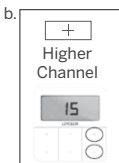

HIDE UNUSED CHANNELS

a. Press and Hold (about 3 sec) “-” and “+” buttons simultaneously until wall switch displays “C” (channel).

b. Press “-” or “+” button to select required quantity of channel (between 1 to 15).

c. Press “Stop” button to confirm selection (the example shows a 5-channel selection). The LED will display “O” (OK) once to confirm selection.

Action on Wall Switch

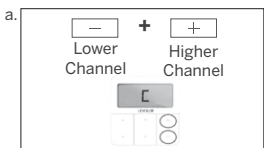

Wall Switch Response

Action on Wall Switch

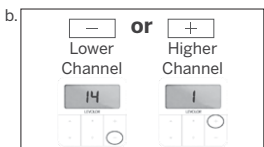

Wall Switch Response

Action on Wall Switch

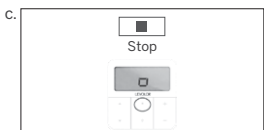

Wall Switch Response

GETTING STARTED

It is important to confirm that the motor is awake and ready to receive programming. To do this, press “P1” button on the motor less than 1 sec, to activate the motor from Sleep Mode.

1. PAIR / UNPAIR WALL SWITCH

*Cellular, Natural, Roman Shades, and Horizontal Blind Motors DO NOT BEEP.

a. Press “P1” button (about 2 sec) on the motor head until motor jog x1 and beep x1.

b. In the next 10 secs, press and hold “Stop” button on the wall switch until motor jog x2 and beep x3.

* Repeat the same procedure to unpair wall switch.

Action on Motor



Motor Response

Action on Wall Switch



Motor Response

2. CHANGE MOTOR DIRECTION (IF NECESSARY)

Press “Up” or “Down” button to check if the shade moves in the desired direction.

If you need to reverse the direction, press and hold (about 2 sec) “Up” and “Down” buttons simultaneously until motor jog x1 and beep x1.

Action on Wall Switch



Motor Response

*The operation is only valid when there are no limits. If the motor has already set the upper and lower limit, then you can only switch direction by pressing “P1” button (about 10 sec) on the motor head until motor jog x3 and beep x3.

3. SETTING THE UPPER AND LOWER LIMITS

SET UPPER LIMIT

a. Press “Up” button to raise the shade, then press “Stop” button when it is in the desired upper limit.

b. Press and hold (about 5 sec) “Up” and “Stop” buttons simultaneously until motor jog x2 and beep x3.

Action on Wall Switch

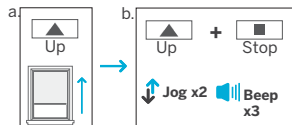

Motor Response

SET LOWER LIMIT

a. Press **"Down"** button to lower the shade, then press **"Stop"** button when it is in the desired lower limit.

b. Press and hold (about 5 sec) **"Down"** and **"Stop"** buttons simultaneously until motor jog x2 and beep x3.

*If you exit the limit setting status before you finish the limit settings, the motor will take the previous existing limits.

Action on Wall Switch

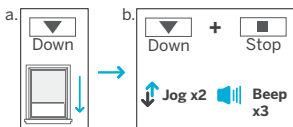

Motor Response

Factory Mode Complete
User Mode Begins

4. ADJUST LIMITS

ADJUST THE UPPER LIMIT

a. Press and hold (about 5 sec) **"Up"** and **"Stop"** buttons simultaneously until motor jog x1 and beep x1.

b. Use **"Up"** button to raise the shade to the desired highest position, and use **"Up"** or **"Down"** button to do the final adjustment if necessary.

c. Press and hold (about 5 sec) **"Up"** and **"Stop"** buttons simultaneously until motor jog x2 and beep x3.

Action on Wall Switch

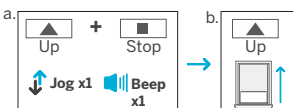

Motor Response

Action on Wall Switch

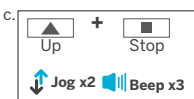

Motor Response

ADJUST THE LOWER LIMIT

a. Press and hold (about 5 sec) **"Down"** and **"Stop"** buttons simultaneously until motor jog x1 and beep x1.

b. Use **"Down"** button to lower the shade to the desired lowest position, and use **"Up"** or **"Down"** button to do the final adjustment if necessary.

c. Press and hold (about 5 sec) **"Down"** and **"Stop"** buttons simultaneously until motor jogs x2 and beeps x3.

Action on Wall Switch

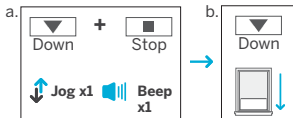

Motor Response

Action on Wall Switch

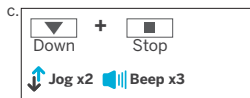

Motor Response

5. FAVORITE POSITION

SET FAVORITE POSITION

a. Use **"Up"** or **"Down"** button to move the shade to desired Favorite position.

b. Press and hold (about 2 sec) one **"P2"** button on the back of wall switch until motor jog x1 and beep x1.

c. Press and hold (about 2 sec) **"Stop"** button until motor jog x1 and beep x1.

d. Once more, press and hold (about 2 sec) **"Stop"** button until motor jog x2 and beep x3.

Action on Wall Switch

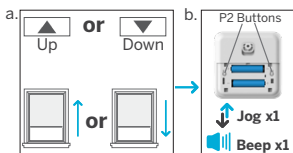

Motor Response

Action on Wall Switch

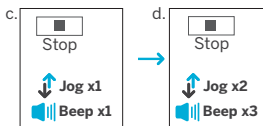

Motor Response

SEND SHADE TO FAVORITE POSITION

Press and hold (about 2 sec) **"Stop"** button, motor will move to Favorite position.

Action on Wall Switch

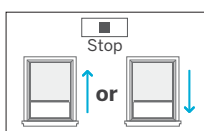

Shade Response

DELETE FAVORITE POSITION

a. Press and hold (about 2 sec) one **"P2"** button until motor jog and beep x1.

b. Press and hold (about 2 sec) **"Stop"** button until motor jog and beep x1.

c. Once more, press and hold (about 2 sec) **"Stop"** button until motor jog x1 and long beep x1.

Action on Wall Switch

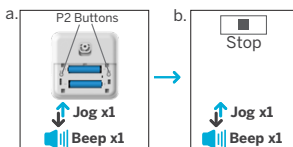

Motor Response

Action on Wall Switch



Motor Response

6. ROLLER MODE AND SHEER MODE

ROLLER SHADE MODE - Default mode, allows for continuous raising/lowering of shade after a short press.

a. Press and hold (about 5 sec) "Up" and "Down" buttons simultaneously until motor jog x1.

b. Press and hold (about 2 sec) "Stop" button until motor jog x2 and beep x3.

Action on Wall Switch

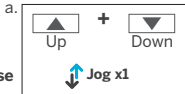

Motor Response

Action on Wall Switch



Motor Response

SHEER SHADE MODE - Allows for slight adjustment after a short press and raising/lowering of shade after a longer press.

a. Press and hold (about 5 sec) "Up" and "Down" buttons simultaneously until motor jog x1.

b. Press and hold (about 2 sec) "Stop" button until motor jog x1 and beep x1.

Action on Wall Switch

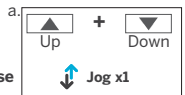

Motor Response

Action on Wall Switch



Motor Response

7. ADD OR REMOVE ADDITIONAL WALL SWITCH

USING CURRENT WALL SWITCH

a. On the **current** wall switch, press and hold (about 2 sec) one "P2" button until motor jog x1 and beep x1.

b. Once more, on the **current** wall switch, press and hold (about 2 sec) one "P2" button until motor jog x1 and beep x1.

c. On the **New** wall switch, press and hold (about 2 sec) one "P2" button until motor jog x2 and beep x3.

*Repeat the same procedure to remove additional wall switch.

Action on Wall Switch

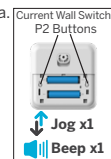

Motor Response

Action on Wall Switch

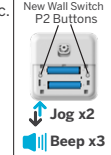

Motor Response

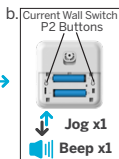

NEW WALL SWITCH CONTROL

Follow instructions under the section 1. Pair / Unpair Wall Switch

8. ADJUST MOTOR SPEED

INCREASE MOTOR SPEED

a. Press one "P2" button until motor jog x1 and beep x1.

b. Press "Up" button until motor jog x1 and beep x1.

c. Once more, press "Up" button until motor jog x2 and beep x1.

Action on Wall Switch

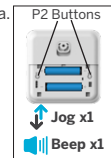

Motor Response

Action on Wall Switch

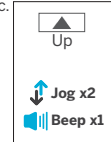

Motor Response

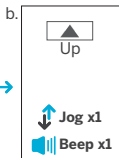

DECREASE MOTOR SPEED

a. Press one "P2" button until motor jog x1 and beep x1.

b. Press "Down" button until motor jog x1 and beep x1.

c. Once more, press "Down" button until motor jog x2 and beep x1.

Action on Wall Switch

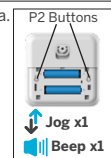

Motor Response

Action on Wall Switch

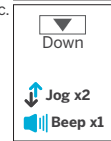

Motor Response

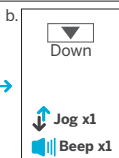

*If the motor has no response, it already has a Maximum or Minimum speed.

LEVOLOR®

InMotion™ Motorization



Solar Panel Installation and Reference Guide

Declarations	2
Safety Instructions	3
InMotion™ Solar Panel Overview	4
Before Installation – What you need to know	5
InMotion™ Solar Panel Installation Guide	7
Troubleshooting	9

SAFETY INSTRUCTIONS

ATTENTION: IMPORTANT SAFETY INSTRUCTION TO BE READ BEFORE INSTALLATION:

- Any changes or modifications to this unit not expressly approved by the party responsible for compliance could void the user's authority to operate the equipment.
- Incorrect installation can lead to serious injury and will void manufacturer's liability and warranty.



IMPORTANT SAFETY INSTRUCTIONS TO BE READ PRIOR TO OPERATION:

- It is important for the safety of persons to follow the enclosed instructions. Save these instructions for future references.
- Persons (including children) with reduced physical, sensory or mental capabilities, or lack of experience or knowledge should not be allowed to use this product.
- Keep Solar Panel away from children.
- Frequently inspect for improper operations. Do not use if repair or adjustment is necessary.

IMPORTANT SAFETY INSTRUCTIONS:

- Do not expose motor to moisture or extreme temperature.
- Do not allow children to play with this device.
- Use or modification outside the scope of this instruction manual will void warranty.
- Installation and programming to be performed by a suitable quality installer.
- For use with Li-ion motors and rechargeable battery packs only.
- Do not cut power cables.
- NOT suitable for exterior application.
- Do not drill into motor body or solar panel body.
- The routing of cable through walls shall be protected by isolating bushing or grommets.
- Ensure power cable is clear and protected from moving parts.
- If cable or power connector is damaged do not use.



Do not dispose of in general waste.

Please recycle batteries and damaged electrical products appropriately.

INMOTION™ SOLAR PANEL OVERVIEW

AVAILABLE PRODUCTS

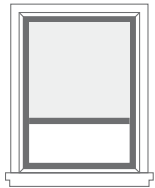

Roller Shades

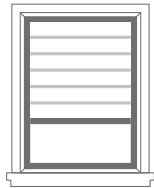

Sheer Shadings

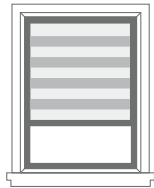

Banded Shades

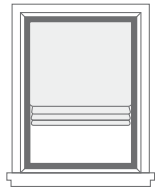

Natural Woven

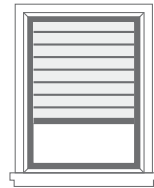

Cellular Shades

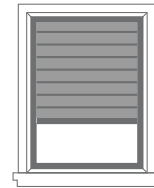

Wood/Faux
Tilt-Only

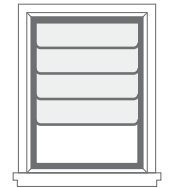

Roman Shades

SPECIFICATIONS

Working Voltage (Vm):	5V
Open circuit voltage (Voc):	6.3V
Short-circuit current (Isc):	659mA
Working current (Im):	606mA
Max. Output Power (Under 1000W/m2):	3W

Electrical performance tolerance:	voltage $\pm 10\%$; current $\pm 10\%$
International solar energy inspection standards:	solar radiation 1000W/m2; 1.5 Air Mass; humidity 25° C
Electricity requirements (each solar panel includes solar battery cells):	conversion efficiency 21%; open circuit voltage (Voc) 6.3V
IP Rating:	IP55
Temp Working Range:	14°F to 122°F (-10°C to 50°C)

DIMENSIONS

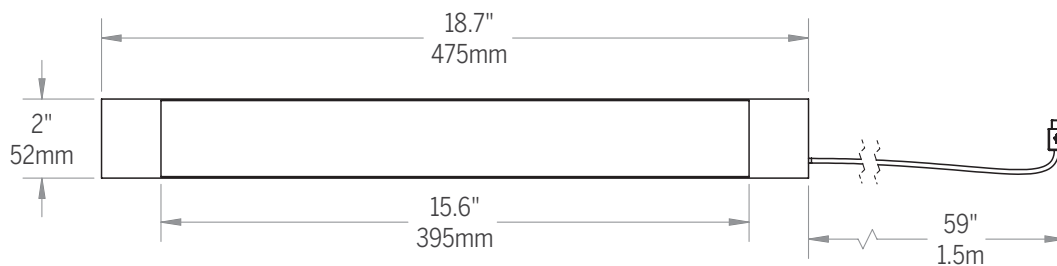

SOLAR PANEL PARTS



1. Solar Panel
2. Cable: Male Micro USB (compatible with all InMotion™ rechargeable battery products)
3. VHB™ Installation tape (Recommended method)
4. Metal "L" Installation Bracket (Alternative method)
5. Screws and Anchors (x4pcs)

BEFORE INSTALLATION – WHAT YOU NEED TO KNOW

CONSIDER THE GEOGRAPHIC LOCATION OF THE INSTALLATION

Understanding the sun’s motion relative to a site is a crucial element to predict the solar panel performance. In other words, a solar panel located in Texas will harvest more energy than a unit installed in Canada (considering both facing south, using similar window). The same can be said between Summer and Winter harvest performance.

As a main recommendation, installations on northern areas are recommended only for small and middle size shades (up to 48" x 60"), with up to one cycle per day. More aspects affect the performance of solar panels and should be considered, not being possible a “one size fits all” approach.

Understanding the sun’s motion relative to a site is a crucial element to predict the solar panel performance. A solar panel located in Texas will harvest more energy than a unit installed in Canada (considering both facing south, using similar window).

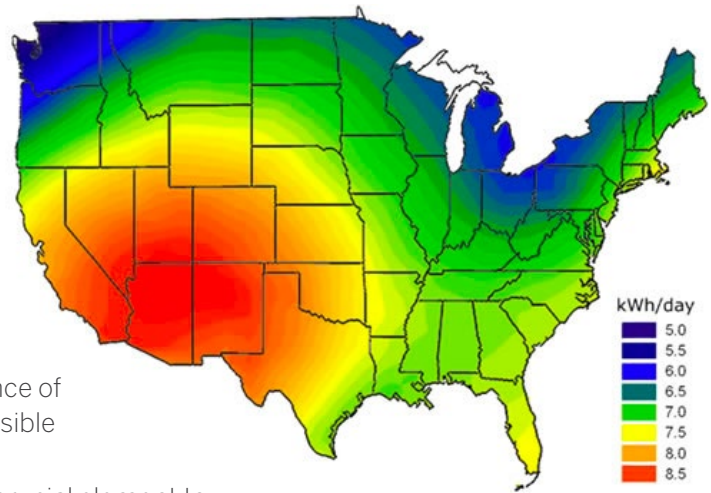

Source: <http://www.fsec.ucf.edu>

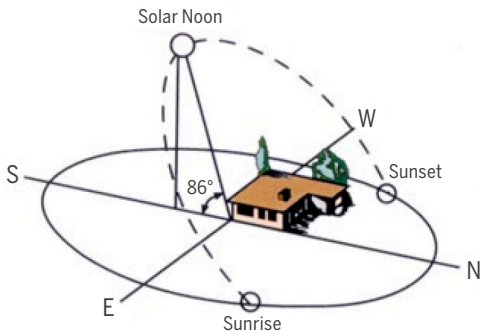

Sun's path on Summer solstice at a southern latitude

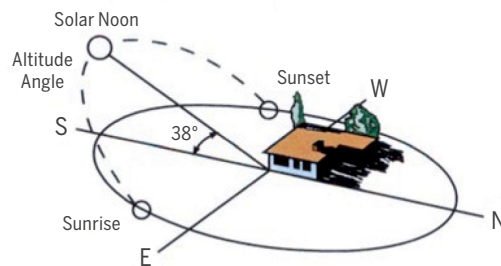

Sun's path on Winter solstice at a southern latitude

The Solar Panel may not be a good fit for every window. In the summer, the sun rises higher in the sky than in the winter months. The further north, the lower the midday winter sun will be. Due to the sun position, Solar panels installed facing north produce 4 times less energy than a device installed facing south. For this reason, we do not recommend the use of solar panel on windows facing North.

	Summer Performance	Winter Performance
South Face	100%	70%
West Face	95%	90%
East Face	90%	70%
North Face	60%	25%

BEFORE INSTALLATION – WHAT YOU NEED TO KNOW

DEFINE THE BEST LOCATION TO INSTALL

The solar panel is designed for indoor use only. To maximize the performance of the solar panel, it should be installed as close as possible to the window glass, allowing as much natural light as possible to reach the panel.

Important

Any element between the Sun light and the solar panel will impact the charging time, and in some situations, prohibit the use of a solar panel. Overcast weather is an example of possible obstruction that impossible to predict or control, but there are other elements that we should consider before installing a solar panel, like:

- Awnings
- Trees
- Deep Eaves
- Tall buildings and walls
- Insect Screen
- Others



Do Not Use Solar Panel Under Below Conditions

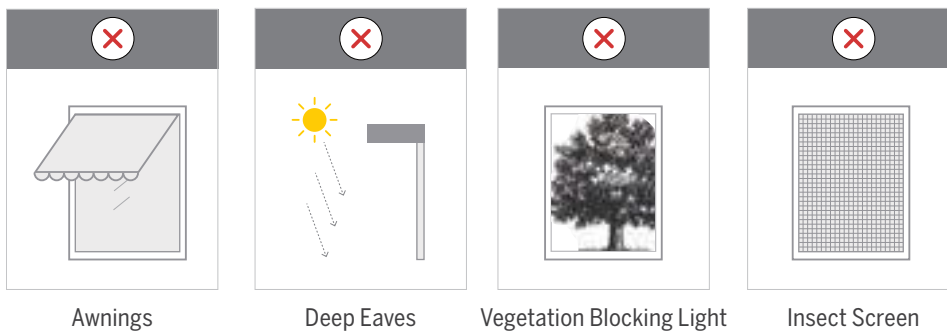

Awnings

Deep Eaves

Vegetation Blocking Light

Insect Screen

Other elements are not so obvious but can make it difficult to use a solar panel. The solar panel will have a low performance when installed on locations with:

- Tinted windows
- High performance glass (also known as energy efficiency glass)
- Multi panel glass
- Any window with treatment that reduces the light transmission below 65%
- Window dividers overlapping solar panel

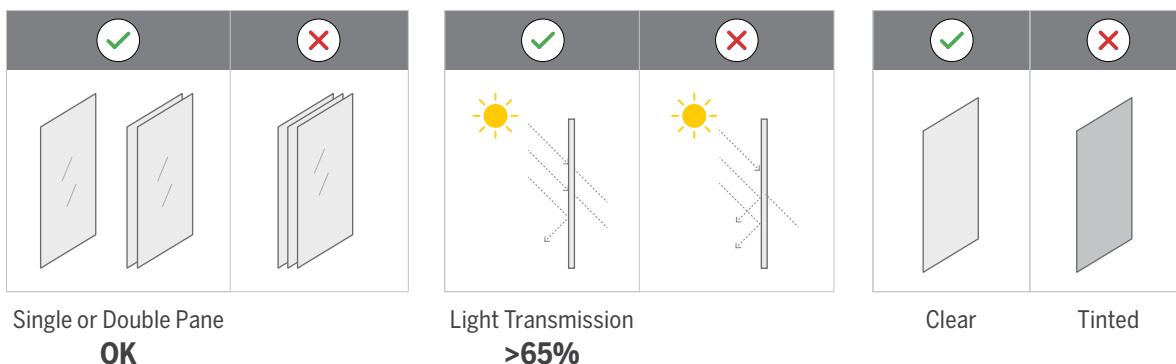

Single or Double Pane
OK

Light Transmission
>65%

Clear

Tinted

BEFORE INSTALLATION – WHAT YOU NEED TO KNOW

HOW EFFICIENT WILL MY SOLAR PANEL PERFORM?

There is no direct answer for this question. Beside all the elements already described that impact how much energy will be harvested from the sun, there is also the question of how fast the energy will be drained by the shade itself due to:

- Shade composition (fabric weight)
- Number of cycles per day
- Size of shade (how long the motor will run per cycle)

The answer for these questions should be considered to evaluate if the solar panel is the best fit for the application.

INMOTION™ SOLAR PANEL INSTALLATION GUIDE

The solar panel must always be install indoors, directly against the window glass to allow as much natural light as possible to reach the panel. For your convenience, the solar panel can be installed using VHB™ installation tape (recommended method) or Metal “L” Installation Bracket (alternative method).

INSTALLATION USING PROVIDED INSTALLATION TAPE

First, clean solar panel corners and window area using alcohol and a cloth pad. Let dry for a few minutes. On a flat surface, place the solar panel facing up and carefully apply the VHB™ installation tape on both sides of the solar panel.



Remove the “face” of the applied adhesive. Position the solar panel facing to outdoors, then press entire panel with firm, even pressure into the glass for 10–15 seconds. The panel is now supported by the adhesive to glass bond but will require 24 hours of cure time to allow full strength characteristics. Do not disturb during this period.

INMOTION™ SOLAR PANEL INSTALLATION GUIDE

ATTACHING “L” INSTALLATION BRACKET TO WINDOW FRAME

The “L” installation bracket is provided as an option when an installation direct on the glass is not possible. A common application is to mount the “L” Bracket on the window frame – either top mount or side mount. Ensure the Solar panel and it’s bracket are not blocking the free movement of the bottom rail.

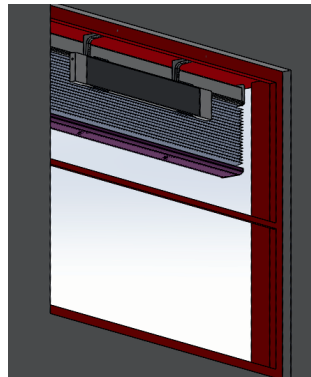

Top Mount



Side Mount

First, install the mounting bracket to wall/mounting point using the screws provided.



Next, adjust the bracket length by lengthening or shortening the “extendable” bracket with the 2 screws.

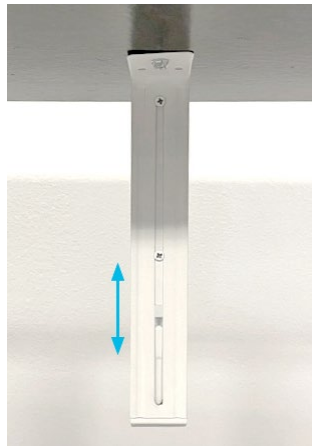

Finally, attach the solar panel into the installation bracket, position the bracket in the center of the solar panel.



INMOTION™ SOLAR PANEL INSTALLATION GUIDE

CONNECT WITH BUILT IN RECHARGEABLE BATTERY MOTOR

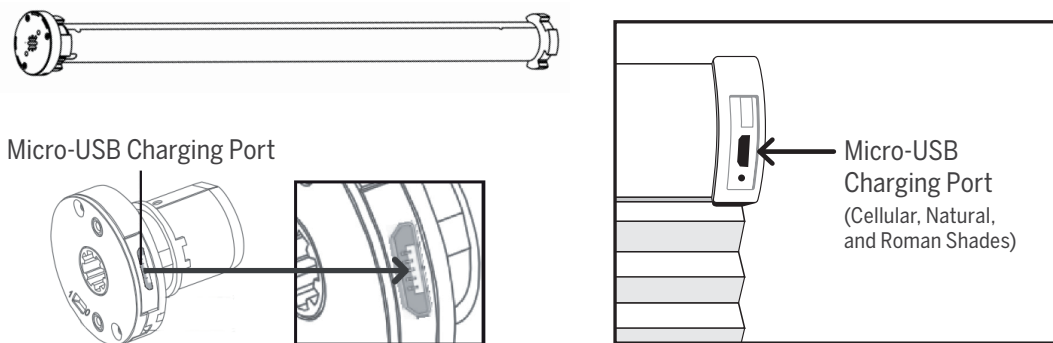
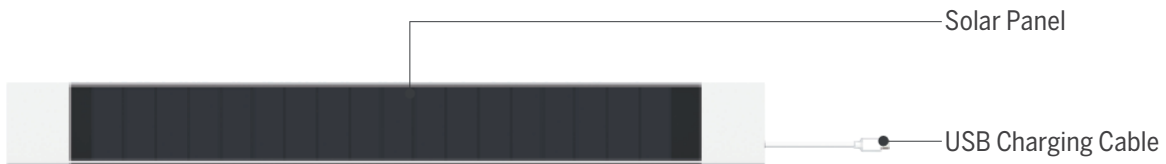

TROUBLESHOOTING

Issues	Possible Causes	Solution
The motor has no response	Battery in motor is depleted	Recharge with compatible charger and check connection and positioning of solar panel
	Insufficient charging from solar panel	Check connection and orientation of solar PV panel
	Remote control battery is discharged	Replace battery
	Battery is inserted incorrectly into remote control	Check battery polarity
	Radio interference/shielding	Ensure remote control and the antenna on the motor are positioned away from metal objects
	Motor/receiver distance is too far from remote control	Move remote control to a closer position
	Power failure	Check power supply to motor is connected and active
	Incorrect wiring	Check that wiring is connected correctly (refer to motor installation instructions)
Motor beeps 10 times when in use	Battery voltage is low/PV (solar panel issue)	Recharge with charger or check connection and positioning of solar panel